

hansgrohe

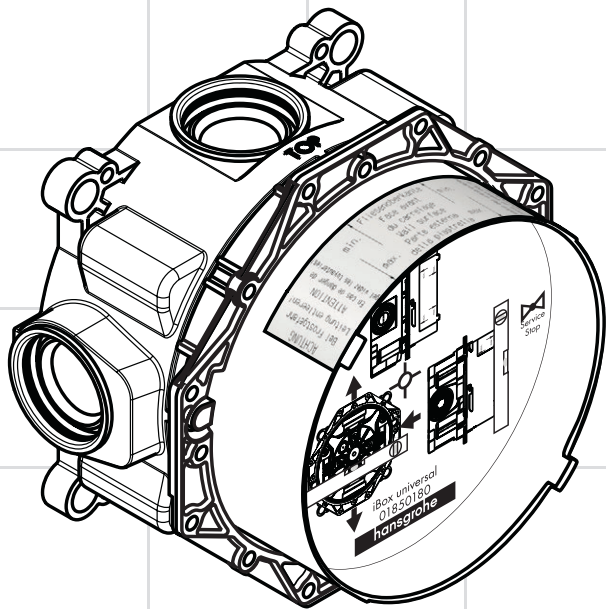

iBox universal
01850180

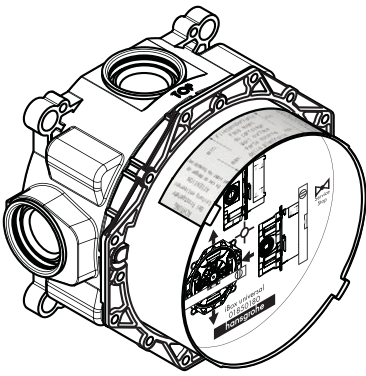

Vorabsperung	Säkerhetsspärr
pointeau d'arrêt	Uždarymo vožtuvas
Isolation valve	Prednja izolacija
Rubinetto arresto	Ön kesme
Válvula de cierre	Ventil de închidere la intrare
Vóórafsluiter	Διάταξη προκαταβολικής φραγής
Forspærre	Izolacijski ventil
Válvula de aislamiento	eeltõkesti
Oddzielacz wstępny	Izolācijas vārsts
izolaciční ventil	Prethodna blokada
Uzatvárací ventil	Forhåndssperre
隔离阀	Предварително блокиране
Предварительная блокировка	Blokimi paragrak
Előlezárást	صمام العزل
Esisulkuventtiili	

schließen / fermé / close / chiudere /
 cerrar / sluiten / lukke / fechar /
 zamknąć / zavřít / uzavrieť / 关 /
 закрыть / bezárás / sulkeminen /
 stänga / uždaryti / Zatvaranje /
 kapatmak / închide / κλειστό / zapreti /
 sulgege / aizvērt / zatvori / lukke /
 затварање / mbylle / إغلاق

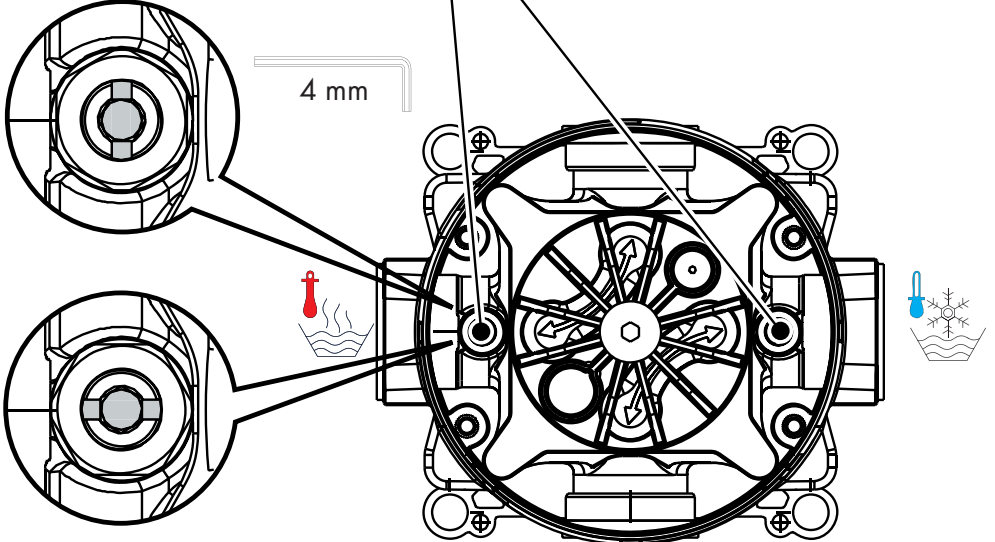

öffnen / ouvert / open / aperto / abierto / open / åbne /
 abrir / otworzyć / otevřít / otvorit / 开 / открыть / nyitás /
 anaaminen / öppna / atidaryti / Otvaranje / açmak /
 deschide / ανοικτό / odpreti / avage / atvērt /
 otvoriti / åpne / отварање / hape / فتح

Rohmontage

Der rotationssymmetrische Grundkörper der iBox ist universell einsetzbar, horizontal wie vertikal. Ausgenommen bei der Montage der Wannensarmatur mit Sicherungskombination, hier ist nur der vertikale Einbau möglich. Da bei einem Defekt der Funktionsteile Wasser an der iBox austreten kann, muss die iBox über der Wanne montiert werden, damit austretendes Wasser in die Wanne abfließen kann!

Die iBox ist sowohl für Wannen- als auch für Brauseninstallation geeignet. Bei Einhand Wannemischer / Thermostat mit Absperr- und Umstellventil ist der untere Abgang vorrangig. Bei Brauseinstallation muss der nicht benötigte Abgang mit einem Stopfen abgedichtet werden.

Große Druckunterschiede zwischen den Kalt- und Warmwasseranschlüssen müssen ausgeglichen werden.

Grundkörper so einbauen, daß sich der Warmwasseranschluß links und der Kaltwasseranschluß rechts befindet.

Einbautiefe 80 mm bis 108 mm.

Verlängerung 25 mm Artikelnummer 13595000

Verlängerung 22 mm (bei geringer Einbautiefe)

Artikelnummer 13593000 / 13596XXX / 13597XXX / 15597000 / 19427000 / 97407XXX / 98860000

Der Grundkörper kann entsprechend der baulichen Gegebenheiten montiert werden (Montagebeispiele siehe Seite 91 und 92).

- A** Installation auf die Wand.
- B** Installation auf die Wand. Hier mit flexiblen Abstandhalter durch 10er Stockschrauben.
- C** Montage auf Trägersystem.
- D** Installation auf Fertighaus-Montageplatten oder Fertigezellen.
- E** Installation direkt in die Wand.
- F** Installation mit Montageschienenstet #96615000.

Installationsbeispiele mit Maßangaben und Leitungsdimensionierung sind ab Seite 96 zu finden. Die Erläuterung der verwendeten Symbole auf Seite 3 und 4.

Die in der Montageanleitung angegebenen Montage Maße sind ideal für Personen von ca. 1800 mm Körpergröße und müssen gegebenenfalls angepasst werden. Hierbei ist darauf zu achten, dass sich bei geänderter Montagehöhe die Mindesthöhe ändert und die Änderung der Anschlussmaße berücksichtigt werden müssen.

Montage-Tipp

Um Anschlussstücke einzudrehen, die iBox mittels eines Rohrstücks in den Schraubstock einspannen.

Spülen

Komplette Installation gemäß DIN 1988 / EN 1717 spülen. Die Pfeile auf dem Spülblock zeigen, welcher Zulauf mit welcher Abgangsleitung verbunden ist, z. B. Kaltwasser mit Abgang 1 und Warmwasser mit Abgang 2. Falls nur ein Abgang benötigt wird, muß nach dem ersten Spülvorgang der Spülblock um 90° gedreht werden.

iBox in Kombination mit einer Exafill Wanneneinlauf mit Ab- und Überlaufgarnitur (siehe Seite 95)

Technische Daten

Betriebsdruck:	max. 1 MPa
Empfohlener Betriebsdruck:	0,1 - 0,5 MPa
Prüfdruck:	1,6 MPa
(1 MPa = 10 bar = 147 PSI)	
Heißwassertemperatur:	max. 80°C
Empfohlene Heißwassertemperatur:	65°C
Anschlussmaße:	G 3/4
Anschlüsse:	kalt rechts - warm links
Freier Durchfluss bei 0,3 MPa:	
Wannenmischer:	31 l/min // 24 l/min
Wannenmischer mit integrierter Sicherungskombination:	
	25 l/min // 24 l/min
Brausemischer:	32 l/min
Thermostat:	43 l/min
Thermostat mit Absperrventil:	26 l/min
Thermostat mit Absperr- und Umstellventil:	26 l/min
Thermostat High Flow:	58 l/min
iControl:	30 l/min

X

Mitte Badewanne / Mitte Duschwanne



Unterputz-Ventil

Y

Maß Y = Mitte Schlauchanschlussbogen bis Mitte Wanneneinlauf dividiert durch 2 (eventuell dem Fliesenraster anpassen).



Quattro Vierwegeumstellung

Quattro



Warmwasser

Kaltwasser



Trio Universal Absperr- und Umstellventil

Trio



Ab • ist die Funktion gewährleistet.



Wanneneinlauf



In diesem Bereich ist eine Wandverstärkung notwendig.



Der nicht benötigte Abgang muss mit einem Blindstopfen abgedichtet werden. (DN 20 3/4")



Nur ein Verbraucher möglich, nicht zwei gleichzeitig.



Die Abflauleistung muss mehr als 50 l/min betragen.

> 50 l/min



Wasserleitungen für Seitenbrausen mit Gefälle verlegen.



Ablauf

Raindrain



Spülblock kpl. #15956000, nicht im Lieferumfang enthalten



Exafill

iBox in Kombination mit einer Exafill Wanneneinlauf mit Ab- und Überlaufgarnitur (siehe Seite 95)

DVGW



Wannenmischer mit integrierter Sicherungskombination (siehe Seite 96)



Brausemischer (siehe Seite 104, 106, 110, 124)



Wannenmischer (siehe Seite 98, 102, 114, 116)

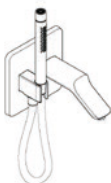

Wanneneinlauf (siehe Seite 102)



Thermostat
(siehe Seite 118, 122, 126)



High Flow Thermostat
(siehe Seite 128 - 138, 142, 144,
150 - 158)



Thermostat mit Absperrventil
(siehe Seite 104, 106, 110, 124)



Thermostat mit Absperr- und Umstell-
ventil
(siehe Seite 98, 114, 116, 120)

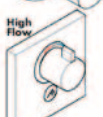

High Flow Thermostat mit Absperr-
ventil
(siehe Seite 140, 146, 148)

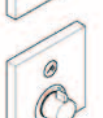

Thermostat mit Absperrventil
(siehe Seite 104, 106, 110)

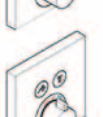

Thermostat mit Absperrventil
(siehe Seite 98, 114, 116, 120)

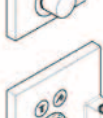

Thermostat mit Absperrventil
(siehe Seite 100, 112)



ShowerSelect Brausemischer
(siehe Seite 104, 106, 110)



ShowerSelect Wannenmischer
(siehe Seite 98, 114, 116, 120)



iControl
Absper- und Umstellventil (siehe Seite
150)



ShowerSelect
3 x Absperventil (siehe Seite 144,
146 - 150, 158)



Raindance Showerpipe
(siehe Seite 108)



Raindance Rainfall 240
(siehe Seite 140, 142)



Raindance Rainfall 180
(siehe Seite 154 - 158)

Raindance E 420
(siehe Seite 150, 152)

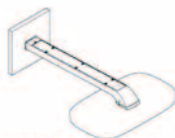

Raindance Select E 300
(siehe Seite 148)

Montage de base

La pièce de base rotative symétrique de l'iBox a une possibilité de montage universel, horizontal comme vertical. Sauf pour le montage d'un mitigeur bain-douche avec disconnecteur ou là le montage vertical seulement est possible. Parce que l'eau pourrait fuir de l'iBox en cas de défaillance des pièces de fonctionnement, l'iBox doit être monté au dessus de la baignoire pour que la fuite puisse s'écouler dans la baignoire.

L'iBox est appropriée aussi bien pour les baignoires que pour les douches. Pour un mitigeur bain/douche / mitigeur thermostatique avec robinet d'arrêt et inverseur, la sortie inférieure est prioritaire. Pour une installation de douche, la sortie non utilisée doit être condamnée avec un bouchon.

Il est conseillé d'équilibrer les pressions de l'eau chaude et froide.

Monter la pièce de base pour que l'eau chaude arrive sur le côté gauche et l'eau froide sur le côté droit.

Profondeur d'encastrement: 80 mm à 108 mm.

jeu de rallonge 25 mm référence 13595000

Rallonge de 22 mm (pour profondeur de montage trop faible)

référence 13593000 / 13596XXX / 13597XXX / 15597000 / 19427000 / 97407XXX / 98860000

La pièce de base peut être installée selon les différentes (possibilités voir pages 91 et 92).

- A** Installation au mur.
- B** Installation au mur avec une vis de distance.
- C** Montage sur système support.
- D** Installation sur des panneaux de montage préfabriqués.
- E** Installation directement dans le mur.
- F** Installation avec rail de fixation #96615000.

Des exemples d'installation avec indication de cotes et dimensions des conduites sont fournis à partir de la page 96. Les symboles utilisés sont expliqués à la page 6 et 7.

Les dimensions d'installation indiquées dans la notice de montage sont idéales pour des personnes d'une taille de 1800 mm environ et doivent être ajustées selon le cas. Tenir compte pour cela du fait qu'un changement de hauteur modifie la hauteur minimum et que la modification des cotes de raccord doit entrer en ligne de compte.

Exemple de montage

Pour monter les différents raccords, on peut fixer l'iBox grâce à un tuyau et un étai.

Rinçage

Rincer l'installation complète conformément à la réglementation et aux normes. Les flèches sur le bloc de rinçage indiquent l'arrivée et la sortie qui doivent être raccordés, par exemple eau froide avec sortie 1 et eau chaude avec sortie 2. Si on utilise seulement une sortie, on devra après le premier rinçage tourner de 90° le bloc de rinçage.

iBox en combinaison avec un remplissage exafill avec mécanisme de vidage et de trop plein (voir page 95)

Informations techniques

Pression de service autorisée:	max. 1 MPa
Pression de service conseillée:	0,1 - 0,5 MPa
Pression maximum de contrôle:	1,6 MPa
[1 MPa = 10 bar = 147 PSI]	
Température d'eau chaude:	max. 80°C
Température recommandée:	65°C
Dimension d'arrivée:	G 3/4
Raccordement:	froide à droite - chaude à gauche
Débit libre à 0,3 MPa:	
Mitigeur bains-douches:	31 l/min // 24 l/min
Mitigeur bains-douches avec disconnecteur:	25 l/min // 24 l/min
Mitigeur douche:	32 l/min
Mitigeur thermostatique:	43 l/min
Mitigeur thermostatique avec robinet d'arrêt:	26 l/min
Mitigeur thermostatique avec robinet d'arrêt et inverseur:	26 l/min
Mitigeur thermostatique High Flow:	58 l/min
iControl:	30 l/min

X	Centre de la baignoire / Centre cuvette de douche		Robinet d'arrêt encastré
Y	Dimension Y = du centre raccord coudé de douche au centre bec déverseur divisé par 2 (éventuellement s'adapter au carrelage).		Quattro inverseur quatre voies
	Eau chaude		Trio Robinet d'arrêt avec inverseur
	Eau froide	Trio	
	A partir de • le fonctionnement est garanti.		Bec déverseur
	Le mur n'a pas besoin d'être renforcé à cet endroit		La sortie non utilisée doit être condamnée avec un bouchon laiton. (DN 20 3/4")
	Une seule utilisation possible, pas les deux ensemble.		Le débit de vidage doit être supérieur à 50 l/min.
	La tuyauterie des douchettes latérales à installer avec une pente.	> 50 l/min	
	bloc d'essai #15956000, ne fait pas partie de la fourniture		Vidage Raindrain iBox en combinaison avec un remplissage exafill avec mécanisme de vidage et de trop-plein (voir page 95)
DVGW			



Mitigeur bains-douches avec disconnecteur (voir pages 96)



Mitigeur bains-douches (voir pages 98, 102, 114, 116)



Mitigeur douche (voir pages 104, 106, 110, 124)

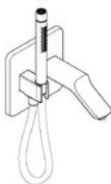

Bec déverseur (voir pages 102)



Mitigeur thermostatique
(voir pages 118, 122, 126)



High Flow

High Flow Mitigeur thermostatique
(voir pages 128 - 138, 142, 144, 150 - 158)



Mitigeur thermostatique avec robinet d'arrêt
(voir pages 104, 106, 110, 124)



Mitigeur thermostatique avec robinet d'arrêt et inverseur
(voir pages 98, 114, 116, 120)



High Flow

High Flow Mitigeur thermostatique avec robinet d'arrêt
(voir pages 140, 146, 148)

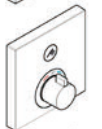

Mitigeur thermostatique avec robinet d'arrêt
(voir pages 104, 106, 110)



Mitigeur thermostatique avec robinet d'arrêt
(voir pages 98, 114, 116, 120)



Mitigeur thermostatique avec robinet d'arrêt
(voir pages 100, 112)



ShowerSelect Mitigeur douche
(voir pages 104, 106, 110)



ShowerSelect Mitigeur bains-douches
(voir pages 98, 114, 116, 120)



iControl
Robinet d'arrêt et inverseur (voir pages 150)

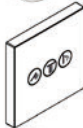

ShowerSelect
3 x robinet d'arrêt (voir pages 144, 146 - 150, 158)



Raindance Showerpipe
(voir pages 108)



Raindance Rainfall 240
(voir pages 140, 142)

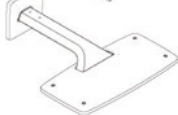

Raindance Rainfall 180
(voir pages 154 - 158)

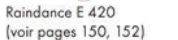

Raindance E 420
(voir pages 150, 152)

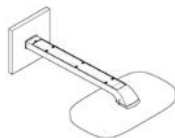

Raindance Select E 300
(voir pages 148)

Concealed installation

The rotation symmetrical body is horizontal and vertical usable. Only exception installing the bath-shower mixer with integrated safety combination. In this case only a vertically installation is possible. Install the iBox always above the bath-tub. If parts of the iBox will broken, the water can flow in there!

The iBox is suitable for both bath and shower applications. When using the bath-shower mixer / thermostatic mixer with shut off and diverter unit outlet, the lower outlet must have priority. For shower applications, plug the unused outlet with a plug.

The hot and cold supplies must be of equal pressures. Install body with the hot water supply left and cold water supply right.

Depth of fitting: 80 mm to 108 mm.

extension 25 mm article number 13595000

Extension Set 22 mm (when wall is not deep enough).
article number 13593000 / 13596XXX / 13597XXX / 15597000 / 19427000 / 97407XXX / 98860000

The iBox can depending on the building application be mounted in different ways, Installation examples please see page 91 and 92.

- A** Direct wall installation.
- B** Direct wall installation with 10 mm adjustable mounting studs.
- C** Installation on carrier system.
- D** Hollow wall installation.
- E** Brick wall installation.
- F** Installation with fixation set #96615000.

Installation examples with measurements and pipe dimensions can be found starting on page 96. The used symbols are explained on pages 9 and 10.

The installation dimensions stated in these installation instructions are ideal for people of approximately 1800 mm in body height. The dimensions can be altered if required. In this case, pay attention to the fact that a change of installation height will also change the minimum height, and that the altered mounting dimensions must be taken into consideration.

Installation tip

To install the supply pipes, fix the iBox with a pipe in a vice.

Flush piping system

To complete the installation flush out both hot and cold water supply. The arrows on the flush body are showing, which inlet is connected with which outlet, for example cold water supply with outlet 1 and hot water supply with outlet 2. If only one outlet is in use, after first flushing the flush body must turned about 90°.

iBox in combinaton with an Exafill bath filler with overflow and waste (see page 95)

Technical Data

Operating pressure:	max. 1 MPa
Recommended operating pressure:	0,1 - 0,5 MPa
Test pressure:	1,6 MPa
(1 MPa = 10 bar = 147 PSI)	
Hot water temperature:	max. 80 °C
Recommended hot water temp.:	65 °C
Centre distance:	G ¾
Connections:	cold right - hot left
Rate of flow by 0,3 MPa:	
Bath-shower mixer:	31 l/min // 24 l/min
Bath-shower mixer with integrated safety combination:	25 l/min // 24 l/min
Shower mixer:	32 l/min
Thermostatic mixer:	43 l/min
Thermostatic mixer with shut off unit:	26 l/min
Thermostatic mixer with shut off and diverter unit:	26 l/min
Thermostatic mixer High Flow:	58 l/min
iControl:	30 l/min

English

X

Center bath tub / Center shower tub



Shut off valve

Y

Dimension Y = center of hose wall outlet elbow to centre of bath filler divided by 2 (match to tile layout if applicable).



Quattro 4-Way Diverter Valve

Quattro



Warm water



Trio 2-Way Diverter Valve with integrated Shut-off valve

Cold water

Trio



From • the function is guaranteed.



Bath Spout



The wall must be reinforced in this area.



Plug the unused outlet. (DN 20 3/4")



Only one function is possible.



The waste drain performance must be more than 50 l/min.

> 50 l/min



Install water pipes for body showers with a gradient.



Waste

Raindrain



flushing unit complete #15956000, order as an extra



Exafill

iBox in combination with an Exafill bath filler with overflow and waste (see page 95)

DVGW



Bath-shower mixer with integrated safety combination (see page 96)



Shower mixer (see page 104, 106, 110, 124)



Bath-shower mixer (see page 98, 102, 114, 116)

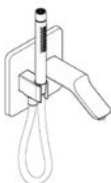

Bath Spout (see page 102)



Thermostatic mixer
(see page 118, 122, 126)



High Flow

High Flow Thermostatic mixer
(see page 128 - 138, 142, 144, 150 - 158)



Thermostatic mixer with shut off unit
(see page 104, 106, 110, 124)

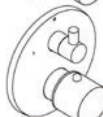

Thermostatic mixer with shut off and diverter unit
(see page 98, 114, 116, 120)

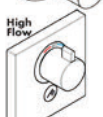

High Flow

High Flow Thermostatic mixer with shut off unit
(see page 140, 146, 148)

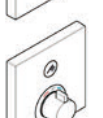

Thermostatic mixer with shut off unit
(see page 104, 106, 110)

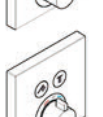

Thermostatic mixer with shut off unit
(see page 98, 114, 116, 120)

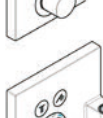

Thermostatic mixer with shut off unit
(see page 100, 112)



ShowerSelect Shower mixer
(see page 104, 106, 110)



ShowerSelect Bath-shower mixer
(see page 98, 114, 116, 120)



iControl
Shut off and diverter unit (see page 150)

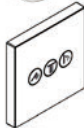

ShowerSelect
3 x stop valve (see page 144, 146 - 150, 158)



Raindance Showerpipe
(see page 108)



Raindance Rainfall 240
(see page 140, 142)

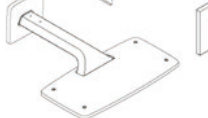

Raindance Rainfall 180
(see page 154 - 158)

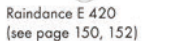

Raindance E 420
(see page 150, 152)

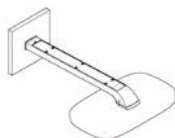

Raindance Select E 300
(see page 148)

Installazione della tubazione

La rotazione simmetrica del corpo permette di raccordarsi agli attacchi sia verticalmente che orizzontalmente. Set vasca/doccia con valvola antiriflusso, è obbligatorio. Solo in caso di installazione del raccordarsi agli attacchi verticalmente. Installare sempre l'iBox sopra alla vasca o al piatto doccia, poiché in caso di fuoriuscita d'acqua questa verrà convogliata allo scarico.

L' iBox è adatto tanto ad installazioni per vasca quanto per doccia. Per i miscelatori monocomando per vasca / termostatico con rubinetto di arresto e deviatore l' uscita inferiore ha la prevalenza. Nelle installazioni per doccia l' uscita non utilizzata deve essere chiusa con un tappo.

Attenzione! Compensare le differenze di pressione tra i collegamenti dell'acqua fredda e dell'acqua calda.

Installare il corpo incasso in modo tale che il raccordo dell' acqua calda si trovi a sinistra e il raccordo dell' acqua fredda a destra.

Profondità d'installazione: da 80 mm a 108 mm.

Prolunga 25 mm codice articolo 13595000

Prolunga 22 mm x set esterno (in caso di incasso troppo esterno al muro).

codice articolo 13593000 / 13596XXX / 13597XXX / 15597000 / 19427000 / 97407XXX / 98860000

Il corpo incasso può essere installato conformemente alle condizioni edilizie, vedi esempi di installazione alle pagg. 91 e 92.

A Installazione a muro.

B Installazione a muro. Qui con la regolazione della distanza (vite nr 10).

C Montaggio su struttura portante.

D Installazione per bagni prefabbricati.

E Installazione diretta a muro.

F Installazione con pareti in cartongesso #96615000.

Esempi per l'installazione con indicazioni delle misure e per le dimensioni delle tubature sono riportati a partire della pagina 96. Per il significato dei simboli impiegati si vedano le pagine 12 e 13.

Le quote di montaggio indicate nelle istruzioni di montaggio sono ideali per persone grandi circa 1800 mm e eventualmente vanno adattate. A ciò bisogna fare attenzione, che ad altezza di montaggio cambiata l'altezza minima necessaria indicata cambia e che bisogna considerare la modifica delle quote di collegamento.

Suggerimento per l' installazione

Per avvitare i raccordi bloccare l' iBox nella morsa come illustrato.

Lavaggio della tubazione

Eseguire il lavaggio della tubazione come suggerisce la normativa DIN 1988 / EN 1717. Indicare sulla copertura del corpo quale alimentazione è collegata a quale tubo di uscita (ad es. acqua fredda con uscita 1 e acqua calda con uscita 2). Nel caso in cui si sia utilizzata una sola uscita, dopo il primo processo di lavaggio la copertura deve essere ruotata di 90° per eseguire il secondo processo di lavaggio.

iBox in combinazione con Exafill scarico con erogazione al troppo pieno (vedi pagg. 95)

Dati tecnici

Pressione d'uso:	max. 1 MPa
Pressione d'uso consigliata:	0,1 - 0,5 MPa
Pressione di prova:	1,6 MPa
(1 MPa = 10 bar = 147 PSI)	
Temperatura dell'acqua calda:	max. 80°C
Temp. dell'acqua calda consigliata:	65°C
Distanza di raccordo:	G ¾
Raccordi:	fredda a destra - calda a sinistra
Portata a 0,3 MPa:	
Miscelatore vasca/doccia:	31 l/min // 24 l/min
Miscelatore vasca incasso con sicurezza (valv. antiriflusso):	25 l/min // 24 l/min
Miscelatore doccia:	32 l/min
Termostatico:	43 l/min
Termostatico con rubinetto di arresto:	26 l/min
Termostatico con rubinetto di arresto e deviatore:	26 l/min
Termostatico High Flow:	58 l/min
iControl:	30 l/min

X

Centro vasca / Centro piatto doccia



Rubinetto di arresto

Y

Valore Y = Dal centro del raccordo a muro al centro della bocca di erogazione vasca diviso 2 (eventualmente adattare alla dimensione delle piastrelle).



Quattro Valvola a quattro vie

Quattro



Acqua calda

Acqua fredda



Trio arresto/deviatore

Trio



Dal • si garantisce la funzionalità.



Bocca di erogazione



In questa zona è necessario un rinforzo della parete.



Chiudere con un tappo l'uscita non utilizzata. (DN 20 3/4")



Non è possibile utilizzare due utenze in contemporanea.



La portata di scarico deve essere superiore a 50 l/min.

> 50 l/min



Posizionare i tubi alle doccette laterali con una leggera pendenza.



Scarico

Raindrain



placca frontale #15956000, non contenuto nel volume di fornitura



Exafill

iBox in combinazione con Exafill scarico con erogazione al troppo pieno (vedi pagg. 95)

DVGW



Miscelatore vasca incasso con sicurezza (valv. antiriflusso) (vedi pagg. 96)



Miscelatore doccia (vedi pagg. 104, 106, 110, 124)



Miscelatore vasca/doccia (vedi pagg. 98, 102, 114, 116)

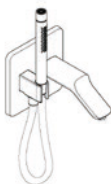

Bocca di erogazione (vedi pagg. 102)



Termostatico
(vedi pagg. 118, 122, 126)



High Flow Termostatico
(vedi pagg. 128 - 138, 142, 144, 150 - 158)



Termostatico con rubinetto di arresto
(vedi pagg. 104, 106, 110, 124)



Termostatico con rubinetto di arresto e deviatore
(vedi pagg. 98, 114, 116, 120)

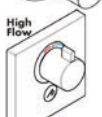

High Flow Termostatico con rubinetto di arresto
(vedi pagg. 140, 146, 148)



Termostatico con rubinetto di arresto
(vedi pagg. 104, 106, 110)

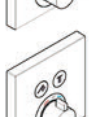

Termostatico con rubinetto di arresto
(vedi pagg. 98, 114, 116, 120)

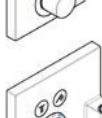

Termostatico con rubinetto di arresto
(vedi pagg. 100, 112)



ShowerSelect Miscelatore doccia
(vedi pagg. 104, 106, 110)



ShowerSelect Miscelatore vasca/
doccia
(vedi pagg. 98, 114, 116, 120)



iControl
Rubinetto di arresto e deviatore (vedi
pagg. 150)

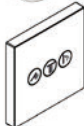

ShowerSelect
3 x rubinetto d'arresto (vedi pagg.
144, 146 - 150, 158)



Raindance Showerpipe
(vedi pagg. 108)



Raindance Rainfall 240
(vedi pagg. 140, 142)



Raindance Rainfall 180
(vedi pagg. 154 - 158)

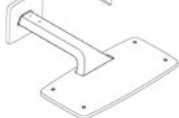

Raindance E 420
(vedi pagg. 150, 152)

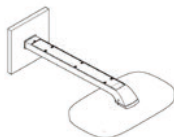

Raindance Select E 300
(vedi pagg. 148)

Montaje del cuerpo empotrado

El cuerpo base del iBox universal se puede montar en plano horizontal y vertical. La única excepción se da al instalar el mezclador de baño/ducha con combinación de seguridad integrada. En tal caso, solo la instalación vertical es posible. Instalar el iBox siempre por encima de la bañera ya que, si se rompiera alguna pieza del iBox, el agua estaría contenida.

El iBox universal puede ser utilizado para una grifería baño/ducha o ducha. En combinación con una instalación de baño/ducha / termostato con llave de paso y distribuidor tiene prioridad la salida inferior. En combinación con un monomando ducha debe taparse la salida que no se utiliza.

Grandes diferencias de presión en servicio entre agua fría y agua caliente deben equilibrarse.

Montar el cuerpo de tal manera que el agua caliente está a la izquierda y el agua fría está en la derecha.

Profundidad de montaje 80 mm a 108 mm.

Prolongación 25 mm artículo número 13595000

Alargo 22 mm (en caso de pared delgada)

artículo número 13593000 / 13596XXX / 13597XXX / 15597000 / 19427000 / 97407XXX / 98860000

El cuerpo empotrado puede ser colocado según los ejemplos expuestos en las páginas 91 y 92.

- A** Instalación directamente sobre la pared.
- B** Instalación sobre la pared. Aquí con soportes de distanciamiento y tornillos de acero de 10.
- C** Montaje en el sistema portante.
- D** Instalación en placas murales prefabricados.
- E** Instalación directa en la pared.
- F** Instalación con set de guías de fijación #96615000.

A partir de la página 96 puede consultar ejemplos de instalación y dimensionamiento de la conducción. La aclaración de los símbolos utilizados en las páginas 15 y 16.

Las medidas indicadas en las instrucciones de montaje resultan ideales para personas de 1800 mm de altura, por lo que deberán ajustarse siempre que sea necesario. En este sentido, es importante tener en cuenta que, en caso de modificación de la altura de montaje, cambia la altura mínima y habrá que adaptar las medidas de conexión.

Recomendación

Para enroscar los codos de conexión, fijar el iBox universal mediante un trozo de tubería en un tornillo de banco.

Purga de la tubería

Purgar la instalación según la normativa DIN 1988/EN 1717. Las flechas en el bloque de purgar indican qué entrada está conectada con qué salida. Si solamente utilizará una salida se ha de girar el bloque de purgar en 90° después del primer proceso de purgar.

iBox universal en combinación con Exafil, vaciador automático con chorro incorporado y rebosadero (ver página 95)

Datos técnicos

Presión en servicio:	max. 1 MPa
Presión recomendada en servicio:	0,1 - 0,5 MPa
Presión de prueba:	1,6 MPa
(1 MPa = 10 bar = 147 PSI)	
Temperatura del agua caliente:	max. 80°C
Temp. recomendada del agua caliente:	65°C
Racores excéntricos:	G 3/4
Racores excéntricos:	a la derecha frío - a la izquierda caliente
Caudal con 0,3 MPa	
Monomando baño/ducha:	31 l/min // 24 l/min
Monomando baño ducha con válvula anti-retorno:	25 l/min // 24 l/min
Monomando ducha:	32 l/min
Termostato:	43 l/min
Termostato con llave de paso:	26 l/min
Termostato con llave de paso y distribuidor:	26 l/min
Termostato High Flow:	58 l/min
iControl:	30 l/min

X

Centro de la bañera / Centro la plato de ducha



Llave de paso

Y

Medida Y = Desde el centro del racor de empalme hasta el centro de la boca de entrada a la bañera dividido por 2 (si fuera necesario, adaptar a la trama de los azulejos).



Quattro válvula de 4 vías

Quattro



Agua caliente



Trio llave de paso y distribuidor

Trio

Agua fría



Mínimo • para el correcto funcionamiento.



Caño de bañera



En este sector es necesario un refuerzo del muro.



La salida que no se utiliza debe ser tapada. (DN 20 3/4")



Sólo una función posible, no dos funciones al mismo tiempo.



El caudal de desagüe debe ser como mínimo de 50 l/min

> 50 l/min



Tubería hacia las duchas laterales con pendiente.



Desagüe

Raindrain



Carcasa para purgar #15956000, no incluido en el suministro



iBox universal en combinación con Exafill, vaciador automático con chorro incorporado y rebosadero (ver página 95)

Exafill

DVGW



Monomando baño ducha con válvula anti-retorno (ver página 96)



Monomando ducha (ver página 104, 106, 110, 124)



Monomando baño/ducha (ver página 98, 102, 114, 116)

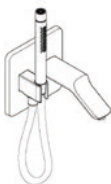

Caño de bañera (ver página 102)



Termostato
(ver página 118, 122, 126)



High Flow

High Flow Termostato
(ver página 128 - 138, 142, 144, 150 - 158)



Termostato con llave de paso
(ver página 104, 106, 110, 124)



Termostato con llave de paso y distribuidor
(ver página 98, 114, 116, 120)

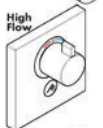

High Flow

High Flow Termostato con llave de paso
(ver página 140, 146, 148)

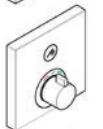

Termostato con llave de paso
(ver página 104, 106, 110)



Termostato con llave de paso
(ver página 98, 114, 116, 120)



Termostato con llave de paso
(ver página 100, 112)



ShowerSelect Monomando ducha
(ver página 104, 106, 110)



ShowerSelect Monomando baño/ ducha
(ver página 98, 114, 116, 120)



iControl
Llave de paso y distribuidor (ver página 150)

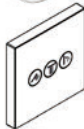

ShowerSelect
3 x Llave de paso (ver página 144, 146 - 150, 158)



Raindance Showerpipe
(ver página 108)



Raindance Rainfall 240
(ver página 140, 142)



Raindance Rainfall 180
(ver página 154 - 158)

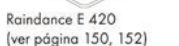

Raindance E 420
(ver página 150, 152)

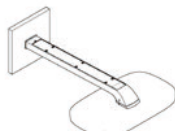

Raindance Select E 300
(ver página 148)

Ruwbouw

Het symmetrische basiscarnitur iBox universeel is zowel horizontaal als verticaal toe te passen. Uitgezonderd bij montage van een badmengkraan met zekerheidscombinatie, deze kan alleen verticaal worden ingebouwd. Bij een defect functieel kan mogelijk water uit de iBox weglopen. Daarom moet de iBox boven het bad gemonteerd worden. Het lekwater wordt dan in het bad afgevoerd!

De iBox is zowel geschikt voor installatie bij het bad als bij de douche. Bij de ééngreeps badmengkraan / thermostaat met stop- en omstelkraan heeft de onderste uitgang voorrang. Bij installatie in de douche moet de onbenodigde uitgang met een blindstop worden afgedicht.

Grote drukverschillen tussen de koud- en warmwatertoevoer dienen vermeden te worden.

Basiscarnitur zo inbouwen, dat de aansluiting voor warm water links en voor koud water rechts zit.

Inbouwdiepte 80 mm tot 108 mm.

Verlengstuk 25 mm Artikelnummer 13595000

verlengset 22 mm (bij geringe inbouwdiepte)

Artikelnummer 13593000 / 13596XXX / 13597XXX / 13597000 / 19427000 / 97407XXX / 98860000

Het basiscarnitur kan overeenkomstig de situatie ter plaatse worden ingebouwd. Montagevoorbeelden zie pag. 91 en 92.

- A** Installatie voor de wand.
- B** Installatie voor de wand.
- C** Montage op houdersysteem.
- D** Installatie in prefab systemen.
- E** Installatie in de wand.
- F** Installatie met montageset #96615000.

Installatievoorbeelden met massagegegevens en capaciteitsdimensionering staan op pagina 96. De toelichting bij de gebruikte symbolen op pagina 18 en 19.

De in de handleiding aangegeven montagegematen richten zich op personen van ca. 1800 mm groot en moeten indien nodig aangepast worden. Daarbij moet in acht genomen worden dat bij een gewijzigde montagehoogte ook de minimumhoogte verandert en dat de aansluitmaten overeenkomstig moeten worden aangepast.

Montagetip

Om aansluitingen in te draaien de iBox door middel van een koppeling in de bankschroef vastzetten.

Spoelen

De complete installatie overeenkomstig DIN 1988/EN 1717 spoelen. De pijlen op het spoelblok geven aan welke ingang met welke uitgang verbonden is, bijv. koud water met uitgang 1 en warm water met uitgang 2. Wanneer slechts 1 uitgang wordt gebruikt, moet men na de eerste spoeling het spoelblok 90° draaien.

iBox in combinatie met Exafill badvuul-, afvoer- en overloopgarnituur (zie blz. 95)

Technische gegevens

Werkdruk: max.	max. 1 MPa
Aanbevolen werkdruk:	0,1 - 0,5 MPa
Getest bij:	1,6 MPa
(1 MPa = 10 bar = 147 PSI)	
Temperatuur warm water:	max. 80°C
Aanbevolen warm water temp.:	65°C
Aansluitmaten:	G ¾
Aansluitingen:	koud rechts - warm links
Vrije doorstroom bij 0,3 MPa:	
Badmengkraan:	31 l/min // 24 l/min
Badmengkraan met geïntegreerde zekerheidscombinatie:	25 l/min // 24 l/min
Douchemengkraan:	32 l/min
Thermostaat:	43 l/min
Thermostaat met stopkraan:	26 l/min
Thermostaat met stop- en omstelkraan:	26 l/min
Thermostaat High Flow:	58 l/min
iControl:	30 l/min

X

Midden bad / Midden Douchebak



Inbouwstopkraan

Y

Maat Y = afstand tussen muuraansluitbocht en baduitloop hart op hart, gedeeld door 2 (eventueel rekening houden met de wandtegels).



Quattro 4-weg omstelkraan

Quattro



Warm water



Trio stop- en omstelkraan

Koud water

Trio



Vanaf • is het functioneren gegarandeerd.



Baduitloop



In dit bereik is een wandversterking noodzakelijk.



De niet benodigde uitgang moet met een blindstop worden afgedicht. (DN 20 3/4")



Slechts 1 functie mogelijk: geen 2 functies tegelijkertijd.



De afvoercapaciteit moet meer dan 50 l/min bedragen.

> 50 l/min



Waterleidingen voor zijdouches aflopend plaatsen.



Afvoer

Raindrain



spoelblok kompl. #15956000, behoort niet tot het leveringspakket



iBox in combinatie met Exafill badvul-, afvoer- en overloopgarnituur (zie blz. 95)

Exafill

DVGW



Badmengkraan met geïntegreerde zekerheidscombinatie (zie blz. 96)



Douchemengkraan (zie blz. 104, 106, 110, 124)



Badmengkraan (zie blz. 98, 102, 114, 116)

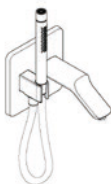

Baduitloop (zie blz. 102)



Thermostaat
(zie blz. 118, 122, 126)



High Flow

High Flow Thermostaat
(zie blz. 128 - 138, 142, 144, 150 - 158)



Thermostaat met stopkraan
(zie blz. 104, 106, 110, 124)



Thermostaat met stop- en omstelkraan
(zie blz. 98, 114, 116, 120)

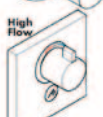

High Flow

High Flow Thermostaat met stopkraan
(zie blz. 140, 146, 148)

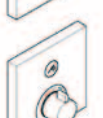

Thermostaat met stopkraan
(zie blz. 104, 106, 110)

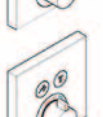

Thermostaat met stopkraan
(zie blz. 98, 114, 116, 120)

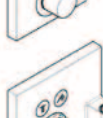

Thermostaat met stopkraan
(zie blz. 100, 112)



ShowerSelect Douchemengkraan
(zie blz. 104, 106, 110)



ShowerSelect Badmengkraan
(zie blz. 98, 114, 116, 120)



iControl
Stop- en omstelkraan (zie blz. 150)



ShowerSelect
3 x inbouwstopkranen (zie blz. 144, 146 - 150, 158)



Raindance Showerpipe
(zie blz. 108)



Raindance Rainfall 240
(zie blz. 140, 142)



Raindance Rainfall 180
(zie blz. 154 - 158)



Raindance E 420
(zie blz. 150, 152)

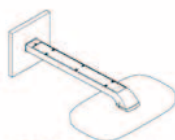

Raindance Select E 300
(zie blz. 148)

Råmontage

I-boxens grundkrop er universel – kan monteres horisontalt og vertikalt. Undtagelsen er dog ved montering af kar/brusearmaturet med integreret sikkerhedskombination, her er kun den vertikale montering mulig. Da der ved evt. defekt vil komme vand i i-boxen, skal denne monteres over karet, således at vandet ledes ned i karet!

I-boxen er egnet til såvel kar- som til bruseinstallation. Ved 1-grebs kararmatur / termostat med afspæringsventil og omskifter er afgang forneden primærafgang. Ved bruseinstallation skal den overfløede afgang afroppes.

Større trykforskelle mellem koldt og varmt vand bør udjævnes.

Grundkroppen indbygges således, at varmtvandstilslutningen er til venstre og koldt vandstilslutningen er til højre.

Monteringsdybde 80 mm til 108 mm.

Forlængersæt 25 mm art. nr. 13595000

Forlænger 22 mm (ved for stor indbygningsdybde)

art. nr. 13593000 / 13596XXX / 13597XXX /

15597000 / 19427000 / 97407XXX / 98860000

For monteringseksempler se s. 91 og 92.

- A** Installation på væggen.
- B** Installation på væggen. Her med fleksibel afstandsholder med 10 mm justerbar monterings skrue.
- C** Montering på skinnedsystemet.
- D** Installation på montageplade.
- E** Installation direkte i væggen.
- F** Installation med monterings-skinnesæt #96615000.

Installationseksempler med mål og ledningsdimensioner kan efterlæses fra side 96. Forklaringer til symbolerne findes på side 21 og 22.

Målene i monteringsanvisningen er ideal til personer med en størrelse på 1800 mm og skal i givet fald tilpasses. Herved skal der tages hensyn til, at den mindste højde i tilfælde af en ændret monteringshøjde ændres og at der skal tages hensyn til de ændrede tilslutningsmål.

Monterings-tips

For montering af tilslutningsvinkler, kan iBoxen fastspændes i en skruevinge ved hjælp af et rørstykke.

Gennemskylning

Den komplette installation skal gennemskyllles efter DIN 1988 / EN 1717. Pilene på tegningen viser, hvilke tilgange og afgang der er forbundet med hinanden, f.eks. koldt vand med afgang 1 og varmt vand med afgang 2. I tilfælde hvor kun én afgang benyttes, skal skylleblokken drejes 90° efter første gennemskylning.

iBox i kombination med Exafill påfyldnings- og overløbs garniture (se s. 95)

Tekniske data

Driftstryk:	max. 1 MPa
Anbefalet driftstryk:	0,1 - 0,5 MPa
Prøvetryk:	1,6 MPa
(1 MPa = 10 bar = 147 PSI)	
Varmtvandstemperatur:	max. 80 °C
Anbefalet varmtvandstemperatur:	65 °C
Tilslutningsmål:	G ¾
Tilslutninger:	Koldt højre - varmt venstre
Fri gennemstrømning ved 0,3 MPa:	
Kararmaturer:	31 l/min // 24 l/min
Kararmatur med integreret sikkerhedskombination.:	25 l/min // 24 l/min
Brusearmaturer:	32 l/min
Termostat:	43 l/min
Termostat med afspæringsventil:	26 l/min
Termostat med afspæringsventil og omskifter:	26 l/min
Termostat High Flow:	58 l/min
iControl:	30 l/min

X

Midt badekar / Midt brusekar



Afspæringsventil

Y

Mål Y = Midt slangeudtag til midt kartud divideret med 2 (evt. tilpas med fugerne i fliserne).



Quattro 4-vejs ventil

Quattro



Varmt vand

Kold vand



Trio afspæringsventil og omskifter

Trio



Fra • er funktionen anvendelig.



Kartud



I dette område er en forstærkning af væggen nødvendig.



Afgangen, der ikke benyttes, skal afpropes. (DN 20 ¾")



Det er kun muligt at benytte én funktion ad gangen.



Afløbskapaciteten skal være mere end 50 l/min.

> 50 l/min



Vandledningerne til sidebruserne med fald.



Afløb

Raindrain



Skylleblok kpl. #15956000, ikke med i leveringsomfang



iBox i kombination med Exafill påfyldnings- og overløbsgarniture (se s. 95)

Exafill

DVGW



Kararmatur med integreret sikkerhedskombination. (se s. 96)



Brusearmaturer (se s. 104, 106, 110, 124)



Kararmaturer (se s. 98, 102, 114, 116)

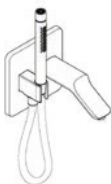

Kartud (se s. 102)



Termostat
(se s. 118, 122, 126)



High Flow

High Flow Termostat
(se s. 128 - 138, 142, 144, 150 - 158)



Termostat med afspæringsventil
(se s. 104, 106, 110, 124)



Termostat med afspæringsventil og omskifter
(se s. 98, 114, 116, 120)

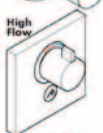

High Flow

High Flow Termostat med afspæringsventil
(se s. 140, 146, 148)



Termostat med afspæringsventil
(se s. 104, 106, 110)



Termostat med afspæringsventil
(se s. 98, 114, 116, 120)



Termostat med afspæringsventil
(se s. 100, 112)



ShowerSelect Brusearmaturer
(se s. 104, 106, 110)



ShowerSelect Kararmaturer
(se s. 98, 114, 116, 120)



iControl
Afspæringsventil og omskifter (se s. 150)



ShowerSelect
3 x Afspæringsventil (se s. 144, 146 - 150, 158)



Raindance Showerpipe
(se s. 108)

Raindance Rainfall 240
(se s. 140, 142)

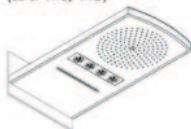

Raindance Rainfall 180
(se s. 154 - 158)

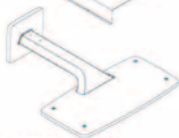

Raindance E 420
(se s. 150, 152)

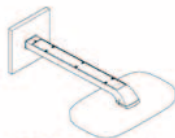

Raindance Select E 300
(se s. 148)

Instalação embutida na parede

O corpo de rotação simétrica pode ser instalado quer na horizontal quer na vertical. A única exceção é ao instalar uma misturadora de banheira/chuveiro com combinação de segurança. Neste caso, apenas é possível uma instalação vertical. Instalar a iBox sempre sobre a banheira. No caso de haver algum defeito nas peças da iBox a água pode fluir para lá.

A iBox é aplicável numa instalação de banheira e de chuveiro. Na misturadora de monobloco para banheira / misturadora termostática com inversor/válvula de corte, a saída inferior é prioritária. Na instalação num chuveiro é necessário vedar a saída desnecessária com um tampão.

Grandes diferenças entre as pressões das águas quente e fria devem ser compensadas.

Instalar o corpo com a ligação para água quente à esquerda e a ligação para a água fria à direita.

Profundidade de montagem 80 mm até 108 mm.

Crescente 25 mm referência 13595000

Crescente 22 mm (quando instalado demasiado longe da parede)

referência 13593000 / 13596XXX / 13597XXX / 15597000 / 19427000 / 97407XXX / 98860000

O corpo pode, dependendo da construção, ser instalado de diferentes maneiras, ver nas páginas 91 e 92 exemplos de instalação

- A** Instalação sobre a parede.
- B** Instalação sobre a parede com calça ajustáveis de 10 mm.
- C** Montagem no sistema de suporte.
- D** Instalação em paredes ocas.
- E** Instalação em paredes de tijolo.
- F** Instalação com set de fixação #96615000.

Exemplos de instalação com indicações dimensionais e dimensionamento das tubagens, podem ser encontrados a partir da página 96. A explicação dos símbolos empregues, encontra-se na página 24 e 25.

As dimensões de montagem indicadas nas instruções de montagem são ideais para pessoas com uma altura aprox. 1800 mm e têm que ser eventualmente adaptadas. Neste contexto deve ter-se em atenção que alterações na altura de montagem obrigam a alterações na altura mínima, bem como alterações nas dimensões de ligação.

Conselho para montagem

Para instalar as curvas de ligação na iBox coloque um tubo na iBox e prenda-o num torno.

Purgar as tubagens

Para completar a instalação purgar as tubagens da água quente e da água fria. As setas no corpo de descarga estão a mostrar que entrada está ligada com que saída, por exemplo, água fria com saída 1 e água quente com saída 2. Se apenas estiver em uso uma saída, após a 1ª purgagem o corpo de descarga deve ser rodado cerca de 90°.

iBox em combinação com Exafill com bica e avisador (ver página (ver página 95)

Dados Técnicos

Pressão de funcionamento:	max. 1 MPa
Pressão de func. recomendada:	0,1 - 0,5 MPa
Pressão testada:	1,6 MPa
[1 MPa = 10 bar = 147 PSI]	
Temperatura da água quente:	max. 80 °C
Temp. água quente recomendada:	65 °C
Distância entre eixos:	G ¾
Ligações:	fria à direita - quente à esquerda
Caudal a 0,3 MPa:	
Misturadora de banheira/chuveiro:	31 l/min // 24 l/min
Misturadora de banheira/duche com combinação de segurança integrada:	25 l/min // 24 l/min
Misturadora de chuveiro:	32 l/min
Misturadora termostática:	43 l/min
Misturadora termostática com válvula de corte:	26 l/min
Misturadora termostática com inversor/válvula de corte:	26 l/min
Misturadora termostática High Flow:	58 l/min
iControl:	30 l/min

X

Meio da banheira / Meio da base de duche



Torneira de passagem

Y

Medida Y=Centro da curva de ligação até ao centro da bica da banheira dividido por 2 (conjugar com os azulejos, se fôr o caso).



Quatro

Quatro válvula de diversão de 4 vias



Água quente



Trio

Trio universal inversor/válvula de corte

Água fria



• A partir deste ponto inicia-se o funcionamento correcto.



Entrada de banheira



Nesta zona é necessário um reforço na parede.



Tamponar a saída não utilizada. (DN 20 3/4")



Apenas uma saída de cada vez, não duas simultaneamente.



Capacidade de escoamento tem que ser superior a 50 l/min.

> 50 l/min



Instalar os tubos para os chuveiros laterais com ligeira inclinação.



Escoamento

Raindrain



Corpo de descarga compl. #15956000, não incluído no volume de fornecimento



Exafill

iBox em combinação com Exafill com bica e avisador (ver página 95)

DVGW



Misturadora de banheira/duche com combinação de segurança integrada (ver página 96)



Misturadora de chuveiro (ver página 104, 106, 110, 124)



Misturadora de banheira/chuveiro (ver página 98, 102, 114, 116)

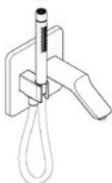

Entrada de banheira (ver página 102)



Misturadora termostática
(ver página 118, 122, 126)



High Flow

High Flow Misturadora termostática
(ver página 128 - 138, 142, 144, 150 - 158)



Misturadora termostática com válvula de corte
(ver página 104, 106, 110, 124)



Misturadora termostática com inversor/válvula de corte
(ver página 98, 114, 116, 120)



High Flow

High Flow Misturadora termostática com válvula de corte
(ver página 140, 146, 148)



Misturadora termostática com válvula de corte
(ver página 104, 106, 110)



Misturadora termostática com válvula de corte
(ver página 98, 114, 116, 120)



Misturadora termostática com válvula de corte
(ver página 100, 112)



ShowerSelect Misturadora de chuveiro
(ver página 104, 106, 110)



ShowerSelect Misturadora de banheira/chuveiro
(ver página 98, 114, 116, 120)



iControl Inversor / válvula de corte (ver página 150)

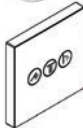

ShowerSelect 3 x Válvula de corte (ver página 144, 146 - 150, 158)



Raindance Showerpipe
(ver página 108)



Raindance Rainfall 240
(ver página 140, 142)

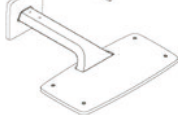

Raindance Rainfall 180
(ver página 154 - 158)

Raindance E 420
(ver página 150, 152)

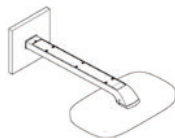

Raindance Select E 300
(ver página 148)

Montaż przyłączy

Uniwersalny okrągły kształt korpusu iBox pozwala na dowolny sposób montażu i zabudowy, zarówno pionowy jak i poziomy. Z wyjątkiem montażu armatury wannowej ze zintegrowanym systemem zabezpieczającym do wylewki, możliwy jest tylko montaż pionowy. W przypadku uszkodzenia jakichkolwiek elementów przepływająca woda może kapać z iBoxa, dlatego też należy zamontować go nad wanną, dzięki czemu woda będzie mogła spływać do wanny.

iBox można wykorzystać zarówno jako baterię wannową jak i jako baterię natryskową. Przy jednouchwytowym mieszaczu wannowym / termostat z zaworem odcinająco-przełączającym dolne wyjście ma pierwszeństwo. Przy instalacji prysznicowej niepotrzebne wyjście musi zostać zamknięte korkiem uszczelniającym.

Znaczne różnice ciśnień na dopływach ciepłej i zimnej wody muszą zostać wyrównane.

Korpus zabudować w taki sposób, aby przyłącza zimnej wody znajdowały się po prawej stronie, a ciepłej po lewej.

Głębokość montażu 80 - 108 mm

Przedłużka 25 mm nr art. 13595000

Rozeta maskująca 22 mm (przy małej głębokości zabudowy)

nr art. 13593000 / 13596XXX / 13597XXX / 13597000 / 19427000 / 97407XXX / 98860000

Korpus może zostać zabudowany w różnych stadiach budowlanych, przykłady montażowe patrz str.91 i 92.

- A** Instalacja na ścianie.
- B** Instalacja przed ścianą. Na śrubach gwintowanych M10 jako elementy dystansowe.
- C** Montaż na systemie stelaży.
- D** Instalacja gotowych płyt montażowych albo gotowych kabinetów.
- E** Instalacja w ścianie.
- F** Instalacja z szynami mocującymi #96615000.

Przykłady instalacji z podaniem ciężarów i rozmiarów przewodów, patrz od strony 96. Wyjaśnienie używanych symboli, patrz strona 27 i 28.

Wymiary montażowe podane w instrukcji montażowej są idealne dla osób o wzroście sięgającym ok. 1800 mm i w razie konieczności należy je dostosować. Należy przy tym zwrócić uwagę na fakt, iż przy zmienionej wysokości montażu zmienia się minimalna wysokość, a także ulegają zmianie wymiary przyłączy.

Wskazówki montażowe

Aby dokręcić przyłącza, zamocować iBox w imadle.

Płukanie

Przepłukać gotową instalację zgodnie z normą. Zaznaczyć strzałką jakie doprowadzenie instalacji odpowiada kolejnemu przyłączu np. zimna woda z odpływem 1, ciepła woda z odpływem 2. W przypadkach gdy wykorzystywane jest tylko jedno wyjście, należy obrócić po pierwszym przepłukaniu o 90° przepłukiwany blok.

iBox w kombinacji z odpływem wannowym Exafill posiadającym możliwość napełniania i opróżniania wanny (patrz strona 95)

Dane techniczne

Ciśnienie robocze:	maks. 1 MPa
Zalecane ciśnienie robocze:	0,1 - 0,5 MPa
Ciśnienie próbne:	1,6 MPa
[1 MPa = 10 bary = 147 PSI]	
Temperatura wody gorącej:	maks. 80°C
Zalecana temperatura wody gorącej:	65°C
Wymiary przyłączy:	G ¾
Przyłącza:	Zimna prawo - ciepła lewo
Swobodny przepływ przy 0,3 MPa:	
Mieszacz wannowy:	31 l/min // 24 l/min
Mieszacz wannowy ze zintegrowanym systemem zabezpieczającym do wylewki:	25 l/min // 24 l/min
Mieszacz prysznicowy:	32 l/min
Termostat:	43 l/min
Termostat z zaworem odcinającym:	26 l/min
Termostat z zaworem odcinająco-przełączającym:	26 l/min
Termostat High Flow:	58 l/min
iControl:	30 l/min

X

Środek wanny / Środek brodzika



Zawór podtynkowy

Y

Wymiar Y = środek mocowania węża przysznicowego do środka wylewki napędzającej wannę podzielony przez 2 (ewentualnie dopasować do układu płytek ceramicznych).



Regulator czterodrożny Quattro

Quattro



Ciepła woda



Zawór odcinający i regulacyjny Trio Universal

Zimna woda

Trio



Od • możliwe jest funkcjonowanie.



Wylewka wannowa



W tym obszarze konieczne jest wzmocnienie ściany.



Niewykorzystany wylot należy zakorkować dołożonym w dostawie korkiem. (DN 20 3/4")



Możliwe uruchamianie tylko każdego odbiornika osobno.



Wydajność odpływu musi być wyższa niż 50 l/min.

> 50 l/min



Przewody doprowadzające do przyszniców bocznych położyć z nachyleniem.



Odpływ

Raindrain



Blok płuczący #15956000, Nie jest częścią dostawy



Exafill

iBox w kombinacji z odpływem wannowym Exafill posiadającym możliwość napełniania i opróżniania wanny (patrz strona 95)

DVGW



Mieszacz wannowy ze zintegrowanym systemem zabezpieczającym do wylewki (patrz strona 96)



Mieszacz przysznicowy (patrz strona 104, 106, 110, 124)



Mieszacz wannowy (patrz strona 98, 102, 114, 116)

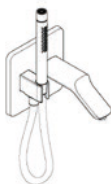

Wylewka wannowa (patrz strona 102)



Termostat
(patrz strona 118, 122, 126)



High Flow Termostat
(patrz strona 128 - 138, 142, 144, 150 - 158)



Termostat z zaworem odcinającym
(patrz strona 104, 106, 110, 124)



Termostat z zaworem odcinająco-przełączającym
(patrz strona 98, 114, 116, 120)



High Flow Termostat z zaworem odcinającym
(patrz strona 140, 146, 148)

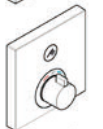

Termostat z zaworem odcinającym
(patrz strona 104, 106, 110)



Termostat z zaworem odcinającym
(patrz strona 98, 114, 116, 120)



Termostat z zaworem odcinającym
(patrz strona 100, 112)



ShowerSelect Mieszacz prysznicowy
(patrz strona 104, 106, 110)



ShowerSelect Mieszacz wannowy
(patrz strona 98, 114, 116, 120)



iControl
Zawór odcinający i regulacyjny (patrz strona 150)

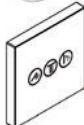

ShowerSelect
3 x Zawór odcinający (patrz strona 144, 146 - 150, 158)



Raindance Showerpipe
(patrz strona 108)

Raindance Rainfall 240
(patrz strona 140, 142)

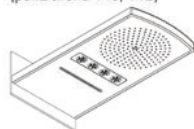

Raindance Rainfall 180
(patrz strona 154 - 158)

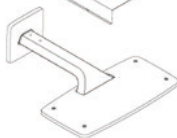
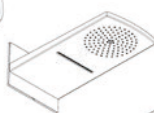

Raindance E 420
(patrz strona 150, 152)

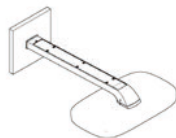

Raindance Select E 300
(patrz strona 148)

Hrubá montáž

Rotačně symetrické základní těleso iBoxu je univerzálně použitelné, horizontálně jakož i vertikálně. Neplatí pro montáž vanové armatury s bezpečnostní kombinací, zde je možná pouze vertikální montáž. Protože v případě závady funkčních dílů může začít z jednotky iBox vytékat voda, musí být iBox instalován nad vanou, která vytékající vodu odvede.

iBox je vhodný jak pro vanovou, tak i pro sprchovou instalaci. U vanové / termostat s uzavíracím a přepínacím ventilem jednoruční pákové baterie je prioritní spodní vývod. U sprchové instalace musí být nepoužitý vývod utěsněn zaslepovací zátkou.

Je nutné vyrovnat velké rozdíly tlaku mezi připoji studené a teplé vody.

Základní těleso zabudovat tak, aby se připojí teplé vody nacházel vlevo a připojí studené vody vpravo.

Hloubka zabudování 80 mm až 108 mm.

prodloužení 25 mm kat.č. 13595000

prodloužení 22 mm (při malé hloubce zabudování)

kat.č. 13593000 / 13596XXX / 13597XXX / 13597000 / 19427000 / 97407XXX / 98860000

Základní těleso může být namontováno v souladu s podmínkami na stavbě, příklady montáže viz strana 91 a 92.

A Instalace na stěnu.

B Instalace před stěnu. Zde s variabilními rozpěrkami pomocí šroubů M 10.

C Montáž na nosný systém.

D Instalace na montážní panely nebo prefabrikované buňky.

E Instalace přímo do stěny.

F Instalace se sadou montážních lišt #96615000.

Příklady instalace s údaji o rozměrech a dimenzování potrubí jsou uvedeny od strany 96. Vysvětlivky k použitým symbolům naleznete na straně 30 a 31.

Montážní rozměry uvedené v návodu pro montáž jsou ideální pro osoby s výškou postavy přibližně 1800 mm a v případě potřeby je nutné je přizpůsobit. Při tom je zapotřebí dbát nato, že se při změně výše montáže změní požadovaná minimální výška a že je třeba brát ohled na připojovací rozměry.

Montážní tip

Abyste bylo možno zatočit připojovací tvarovky do iBoxu, upněte iBox pomocí části trubky do svěráku.

Propláchnutí

Kompletní instalaci vypláchnout podle normy DIN 1988. Šipka na proplachovacím bloku ukazuje, který přívod je spojen se kterým vedením vývodu, např. studená voda s vývodem 1 a teplá voda s vývodem 2. Je-li potřebný pouze jeden vývod, musí být po prvním vypláchnutí proplachovací blok otočen o 90 stupňů.

iBox v kombinaci s vanovým napouštěním Exafill s odpadní a přepadovou garniturou (viz strana 95)

Technické údaje

Provozní tlak:	max. 1 MPa
Doporučený provozní tlak:	0,1 - 0,5 MPa
Zkušební tlak:	1,6 MPa
[1 MPa = 10 bar = 147 PSI]	
Teplota horké vody:	max. 80 °C
Doporučená teplota horké vody:	65 °C
Rozteč připojení:	G 3/4
Připoje:	studená vpravo - teplá vlevo
Volný průtok při 0,3 MPa	
vanová baterie:	31 l/min // 24 l/min
Vanová baterie s integrovanou bezpečnostní kombinací:	25 l/min // 24 l/min
Sprchová armatura:	32 l/min
Termostat:	43 l/min
Termostat s uzavíracím ventilem:	26 l/min
Termostat s uzavíracím a přepínacím ventilem:	26 l/min
Termostat High Flow:	58 l/min
iControl:	30 l/min

X	Střed koupací vany / Střed sprchové vany		Podomítkový uzavírací ventil
Y	Rozměr Y = vzdálenost středu připojení sprchové hadice od středu vanového napouštění dělitelná 2 (eventuelně přizpůsobit rozměru obkladů).	 Quattro	Quattro čtyřcestné přestavování
	Teplá voda	 Trio	Trio Universal - Uzavírací a přepínací ventil
	Studená voda		Vanový vtok
	Od • je zaručená funkce		Nepoužitý vývod musí být utěsněn zaslepovací zátkou. (DN 20 3/4")
	V této oblasti je potřebné zesílení stěny.		Odtokový výkon musí být vyšší než 50 l/min.
	Je možné použít pouze jeden spotřebič, ne dva současně.		Odtok
	Vodovodní potrubí pro boční sprchy nainstalovat se spádem.		iBox v kombinaci s vanovým napouštěním Exafill s odpadní a přepadovou garniturou (viz strana 95)
	výplachový blok kompl. #15956000, není součástí dodávky		Exafill

DVGW

 Vanová baterie s integrovanou bezpečnostní kombinací (viz strana 96)

 vanová baterie (viz strana 98, 102, 114, 116)

 Sprchová armatura (viz strana 104, 106, 110, 124)

 Vanový vtok (viz strana 102)



Termostat
(viz strana 118, 122, 126)



High Flow

High Flow Termostat
(viz strana 128 - 138, 142, 144, 150 - 158)



Termostat s uzavíracím ventilem
(viz strana 104, 106, 110, 124)



Termostat s uzavíracím a přepínacím ventilem
(viz strana 98, 114, 116, 120)

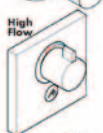

High Flow

High Flow Termostat s uzavíracím ventilem
(viz strana 140, 146, 148)



Termostat s uzavíracím ventilem
(viz strana 104, 106, 110)



Termostat s uzavíracím ventilem
(viz strana 98, 114, 116, 120)



Termostat s uzavíracím ventilem
(viz strana 100, 112)



ShowerSelect Sprchová armatura
(viz strana 104, 106, 110)



ShowerSelect vanová baterie
(viz strana 98, 114, 116, 120)



iControl
Uzavírací a přepínací ventil (viz strana 150)



ShowerSelect
3 x uzavírací ventil (viz strana 144, 146 - 150, 158)



Raindance Showerpipe
(viz strana 108)



Raindance Rainfall 240
(viz strana 140, 142)



Raindance Rainfall 180
(viz strana 154 - 158)

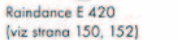

Raindance E 420
(viz strana 150, 152)

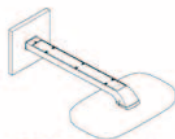

Raindance Select E 300
(viz strana 148)

Hrubá montáž

Rotačne symetrické základné teleso iBoxu je univerzálne použiteľné, horizontálne aj vertikálne. Neplatí pro montáž vanovej armatury s bezpečnostní kombináci, zde je možná pouze vertikální montáž. Pretože v prípade poruchy funkčných častí môže začať z jednotky iBox vytekať voda, musí byť iBox namontovaný nad vaňou, ktorá vytekajúcu vodu odvedie.

iBox je vhodný tak pre vaňovú ako aj sprchovú inštaláciu. Pre jednoručnú pákovú vaňovú batériu / termostatická batéria s uzatváracou jednotkou a prestavovacím ventilom je prioritný spodný vývod. Pre sprchovú inštaláciu musí byť nepoužitý vývod zaslepený zátkou.

Veľké rozdiely v tlaku medzi prípojkami studenej a teplej vody musia byť vyrovnané.

Základné teleso zabudovať tak, aby prívod teplej vody bol vľavo a prívod studenej vody vpravo.

Montážna hĺbka: 80 mm až 108 mm.

Prdlženie 25 mm výrobné číslo 13595000

Prdlženie 22 mm (pri malej montážnej hĺbke).

výrobné číslo 13593000 / 13596XXX / 13597XXX / 15597000 / 19427000 / 97407XXX / 98860000

Základné teleso je montované podľa podmienok na stavbe podľa príkladov inštalácie vii strana 91 a 92.

- A** Inštalácia na stenu.
- B** Inštalácia pred stenu pomocou nastaviteľných 10 mm skrutiek.
- C** Montáž na nosný systém.
- D** Inštalácia na montážne dosky hotového domu alebo hotové bunky.
- E** Inštalácia priamo do steny.
- F** Inštalácia so sadou montážnych lišt #96615000.

Inštaláčne príklady s uvedením rozmerov a výkonov nájdete od strany 96. Vysvetlenie použitých symbolov nájdete na strane 33 a 34.

Montážne rozmery uvedené v návode na montáž sú ideálne pre osoby s výškou postavy približne 1800 mm a v prípade potreby je nutné ich prispôbiť. Pritom je nutné si uvedomiť, že pri zmenenej výške montáže sa mení minimálna výška a je nutné dbať na rozmery rozmiestnenia prípojk.

Montážny tip

Aby sa dali pripojovacie kusy dobre zatočiť, upne sa iBox pomocou trubkovej tvarovky do zveráku.

Prepláchnutie

Kompletnú inštaláciu prepláchnuť podľa normy DIN 1988. Šípka na preplachovacom bloku ukazuje, ktorý prívod je spojený s ktorým vedením vývodu, napr. prívod studenej vody s vývodom 1, prívod teplej vody s vývodom 2. Ak je použitý len jeden vývod, musí byť po prvom prepláchnutí preplachovací blok otočený o 90 stupňov.

iBox kombinovaný s EXAFILL vaňovým napúšťaním s odpadovou a prepádovou garnitúrou (viď strana 95)

Technické údaje

Prevádzkový tlak:	max. 1 MPa
Doporučený prevádzkový tlak:	0,1 - 0,5 MPa
Skúšobný tlak:	1,6 MPa
(1 MPa = 10 bar = 147 PSI)	
Teplota teplej vody:	max. 80 °C
Doporučená teplota teplej vody:	65 °C
Prípádacie rozmery:	G ¾
Prípoje:	studená vpravo - teplá vľavo
Volný prietok pri 0,3 MPa	
vaňová batéria:	31 l/min // 24 l/min
mešalna batéria za kopalno kad z vgrajeno varovalno kombinacijo:	
	25 l/min // 24 l/min
Sprchová batéria:	32 l/min
Termostatická batéria:	43 l/min
Termostatická batéria s uzatváracím ventilom:	26 l/min
Termostatická batéria s uzatváracou jednotkou a prestavovacím ventilom:	26 l/min
Termostatická batéria High Flow:	58 l/min
iControl:	30 l/min

X	Stred vane / Stred sprchovej vane		Podomietkový uzatvárací ventil
Y	Rozmer Y = vzdialenosť stredy pripojenia sprchovej hadice od stredy vaňového napúšťania deliteľná 2 (prípadne prispôsobíť rozmeru obkladu)	 Quattro	Quattro štvorcečné prestavenie
	Teplá voda		Trio univerzálny uzatvárací a prestavovací ventil
	Studená voda	Trio	Vaňový vtok
	Od • je zaručená funkcia.		Nepoužitý vývod musí byť zaslepený zátkou. (DN 20 3/4")
	V tejto oblasti je potrebné zosilnenie steny.		Výkon odtoku musí byť vyšší ako 50 l/min.
	Je možné používať len jeden spotrebič, nie oba súčasne.	> 50 l/min	Odtok
	Vodovodné potrubie pre bočné sprchy vyspádovať.	 Raindrain	iBox kombinovaný s EXAFILL vaňovým napúšťaním s odpadovou a prepadovou garnitúrou (viď strana 95)
	Kompletný vyplachovací blok #15956000, nie je súčasťou dodávky	 Exafill	

DVGW  mešalna batéria za kopalno kad z vgrajeno varovalno kombinacijo (viď strana 96)

 Sprchová batéria (viď strana 104, 106, 110, 124)

 vaňová batéria (viď strana 98, 102, 114, 116)

 Vaňový vtok (viď strana 102)



Termostatická batéria
(viď strana 118, 122, 126)



High Flow

High Flow Termostatická batéria
(viď strana 128 - 138, 142, 144, 150 - 158)



Termostatická batéria s uzatváracím ventilom
(viď strana 104, 106, 110, 124)

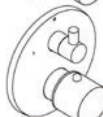

Termostatická batéria s uzatváracou jednotkou a prestavovacím ventilom
(viď strana 98, 114, 116, 120)

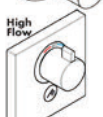

High Flow

High Flow Termostatická batéria s uzatváracím ventilom
(viď strana 140, 146, 148)

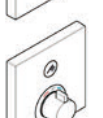

Termostatická batéria s uzatváracím ventilom
(viď strana 104, 106, 110)

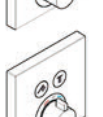

Termostatická batéria s uzatváracím ventilom
(viď strana 98, 114, 116, 120)

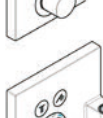

Termostatická batéria s uzatváracím ventilom
(viď strana 100, 112)



ShowerSelect Sprchová batéria
(viď strana 104, 106, 110)



ShowerSelect vaňová batéria
(viď strana 98, 114, 116, 120)



iControl
Uzatvárací a prestavovací ventil (viď strana 150)

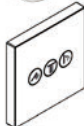

ShowerSelect
3 x uzatvárací ventil (viď strana 144, 146 - 150, 158)



Raindance Showerpipe
(viď strana 108)



Raindance Rainfall 240
(viď strana 140, 142)

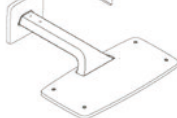

Raindance Rainfall 180
(viď strana 154 - 158)

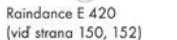

Raindance E 420
(viď strana 150, 152)

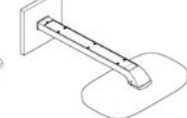

Raindance Select E 300
(viď strana 148)

粗安装

iBox的旋转对称基体可以作为万能部件使用。在此只能垂直安装。始终在浴缸上面安装iBox。如果iBox零件即将断裂，水可能从这里流出！

iBox不仅适用于槽安装，同样也适用于花洒安装。安装单手槽装置/恒温龙头及闭锁和分流器单元时，下出水口优先。安装花洒时，必须使用堵头密封不需要的出水口。

冷热水管间过大的压力差必须予以平衡。

基体安装在热水连接装置左侧和冷水连接装置右侧。

安装深度：80mm至108 mm。

加长 25 mm 商品编号 13595000

加长件22mm（墙壁不够深时）

商品编号 13593000 / 13596XXX / 13597XXX / 15597000 / 19427000 / 97407XXX / 98860000

根据构造的实际情况安装基体。安装范例参见第91页和第92页。

A 直接墙面安装。

B 直接墙面安装，带10 mm可调节的固定柱头螺栓。

C 安装在支柱上。

D 中空墙壁安装

E 砖墙安装

F 使用固定组件安装 #96615000。

带数据和管道尺寸的安装实例请从 96 页起查找。所使用符号的说明参见 36 页和 37 页。

本安装说明中所规定的安装尺寸理想用于身高 1800 mm 左右的人士。尺寸可根据需要进行修改。在这种情况下，您必须留意，如果安装高度改变，则花洒到地板的最小高度也随之改变，且必须考虑到连接尺寸的改变。

安装提示

iBox通过管件在台虎钳内处理，这样可以旋入连接件。

冲洗管系统

按照德国工业标准1988/欧洲标准1717清洁全部安装件。箭头指示清洗端。该流向与该出口导通装置连接，例如：冷水与出口1连接，热水与出口2连接。如果只需要一个出口，那么，在第一个清洁过程后，90°旋转冲洗端。

iBox与下水部件组合，配备出水组件及溢流组件（参见第95页）

技术参数

工作压力:	最大 1 MPa
推荐工作压力:	0,1 - 0,5 MPa
测试压力:	1,6 MPa
(1 MPa = 10 bar = 147 PSI)	
热水温度:	最大 80°C
推荐热水温度:	65°C
中心距离:	G
连接管线:	左热右冷
0,3 MPa时的流速:	
浴缸—淋浴龙头:	31 升/分钟 // 24 升/分钟
浴缸淋浴龙头及整体式安全组合:	25 升/分钟 // 24 升/分钟
淋浴龙头:	32 升/分钟
恒温龙头:	43 升/分钟
恒温龙头及闭锁单元:	26 升/分钟
恒温龙头及闭锁和分流器单元:	26 升/分钟
恒温龙头 High Flow:	58 升/分钟
iControl:	30 升/分钟

X

槽中间 / 中心淋浴盆



截止阀

Y

尺寸Y = 软管壁出口弯管的中心至浴盆加水口中心除以2 (匹配瓷砖布置)。



Quattro 四通转换器

Quattro



热水



通用的三通截止阀和换向阀

冷水

Trio



从开始, 正常功能得以保证。



浴缸出水口



该区域需要一个加固边壁。



插入不使用的插座。(DN 20 “)



只有一项功能。



排水功率必须大于 50 l/min.



安装水管, 用于带有梯度的淋浴器。

> 50 l/min

排水口



Raindrain



全套清洗端 #15956000, 不在供货范围内



Exafill

iBox与下水部件组合, 配备出水组件及溢流组件 (参见第 95 页)

DVGW



浴缸淋浴龙头及整体式安全组合 (参见第页 96)



淋浴龙头 (参见第页 104, 106, 110, 124)



浴缸—淋浴龙头 (参见第页 98, 102, 114, 116)

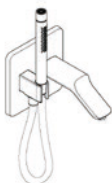

浴缸出水口 (参见第页 102)



恒温龙头
(参见第页 118, 122, 126)



High Flow

High Flow 恒温龙头
(参见第页 128, 138, 142, 144, 150 - 158)



恒温龙头及闭锁单元
(参见第页 104, 106, 110, 124)



恒温龙头及闭锁和分流器单元
(参见第页 98, 114, 116, 120)

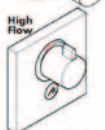

High Flow

High Flow 恒温龙头及闭锁单元
(参见第页 140, 146, 148)

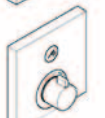

恒温龙头及闭锁单元
(参见第页 104, 106, 110)



恒温龙头及闭锁单元
(参见第页 98, 114, 116, 120)



恒温龙头及闭锁单元
(参见第页 100, 112)



ShowerSelect 淋浴龙头
(参见第页 104, 106, 110)



ShowerSelect 浴缸—淋浴龙头
(参见第页 98, 114, 116, 120)



iControl
截止阀和换向阀 (参见第页 150)



ShowerSelect
3 x 停止阀 (参见第页 144, 146 - 150, 158)



Raindance Showerpipe
(参见第页 108)

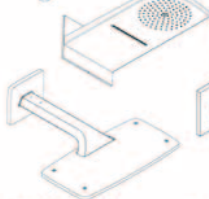

Raindance Rainfall 240
(参见第页 140, 142)

Raindance E 420
(参见第页 150, 152)



Raindance Rainfall
180
(参见第页 154 - 158)

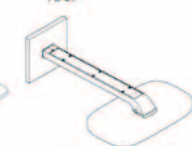

Raindance Select E 300
(参见第页 148)

предварительный монтаж

Вращательно-симметричный корпус iBox может использоваться универсально, как горизонтально, так и вертикально. Кроме монтажа арматуры ванны с комбинированным предохранителем здесь возможна только вертикальная установка. Поскольку при неисправности функциональных деталей у iBox может выходить вода, iBox необходимо монтировать над ванной, чтобы выступающая вода могла стекать в ванну! iBox предназначен для монтажа как ванн, так и душев. Для однорычажного смесителя для ванны / термостата с запорным и регулировочным клапаном преимущество имеет нижний отвод. При монтаже душа ненужный выход необходимо закрыть пробкой. донного клапа. Перед установкой смесителя необходимо регулировочными кранами выровнять давление холодной и горячей воды при помощи вентилей регулирующих подачу воды в квартиру.

Установите корпус так, чтобы подключение горячей воды находилось слева, а холодной – справа.

Глубина установки от 80 до 108 мм.

Удлинение 25 мм арт. № 13595000

Удлинение 22 мм (при малой глубине установки) арт. № 13593000 / 13596XXX / 13597XXX / 15597000 / 19427000 / 97407XXX / 98860000

Корпус может монтироваться, согласно условиям строительства, примеры монтажа см. на стр. 91 и 92.

A варианты установки

B Установка на стене. Здесь с гибким распорным держателем, благодаря винтам 10.

C Монтаж на системе стоек.

D Установка на монтажных плитах сборных домов или блоках сборных домов.

E монтаж в кирпичную стену

F Установка с помощью комплекта монтажных шин #96615000.

Примеры монтажа с указанием размеров и размеры трубопровода см. на стр. 96. Пояснение к используемым символам см. на стр. 39 и 40.

Указанные в монтажной инструкции монтажные размеры идеальны для лиц ростом около 1800 мм. В случае необходимости монтажные размеры следует менять. При этом нужно учесть, что при изменении высоты монтажа меняется также и минимальная высота, а изменение установочных размеров нужно принять во внимание.

Подсказка по монтажу

Для завинчивания фитингов закрепите iBox с помощью куска трубы в тисках.















Промывка

Промывайте все установленное оборудование, согласно DIN 1988 / EN 1717. Стрелки на промывочном блоке показывают, какой вход связан с отводом. напр., холодная вода с отводом 1, а горячая вода - с отводом 2. Если требуется только один отвод, после первой промывки промывочный блок необходимо повернуть на 90°.

iBox в комбинации со впуском ванны Exafill со сливной и переливной гарнитурой (см. стр. 95)

Технические данные

Рабочее давление:	не более. 1 МПа
Рекомендуемое рабочее давление:	0,1 - 0,5 МПа
Давление:	1,6 МПа
[1 МПа = 10 bar = 147 PSI]	
Температура горячей воды:	не более. 80°C
Рекомендуемая темп. гор. воды:	65°C
Размеры подключения:	G 3/4
Подключение:	холодная справа - горячая слева
Свободное истечение при 0,3 МПа:	
Смеситель ванны:	31 л/мин // 24 л/мин
Смеситель ванны со встроенным комбинированным предохранителем:	25 л/мин // 24 л/мин
Смеситель душа:	32 л/мин
Термостат:	43 л/мин
Термостат с запорным вентилем:	26 л/мин
Термостат с запорным и переключающим вентилем:	26 л/мин
Термостат High Flow:	58 л/мин
iControl:	30 л/мин

X	середина ванны / Середина душевой ванны		Скрытый вентиль
Y	Размер Y = середина дуги подключения шланга, деленная на 2 (или подогнать по растр плитки).		Четырехходовой переключатель Quattro
		Quattro	
	Теплая вода		Трехходовой запорный и переключающий вентиль Trio Universal
	Холодная вода	Trio	
	Гарантированное функционирование при показателях выше •.		Водозабор
	В этой области требуется укрепление стены.		Ненужный выход необходимо уплотнить с помощью заглушки. (DN 20 3/4")
	Возможно использование только одного потребителя, не двух одновременно.		Слив должен иметь производительность более 50 л/мин.
	Водопроводы для боковых душей прокладывают под наклоном.	> 50 l/min	
	промывочный блок клп. #15956000, не включено в объем поставки!		Слив
		Raindrain	
			iBox в комбинации со выпуском ванны Exafill со сливной и переливной гарнитурой (см. стр. 95)
		Exafill	

DVGW  Смеситель ванны со встроенным комбинированным предохранителем (см. стр. 96)

 Смеситель душа (см. стр. 104, 106, 110, 124)

 Смеситель ванны (см. стр. 98, 102, 114, 116)

 Водозабор (см. стр. 102)



Термостат
(см. стр. 118, 122, 126)



High Flow

High Flow Термостат
(см. стр. 128 - 138, 142, 144, 150 - 158)



Термостат с запорным вентилем
(см. стр. 104, 106, 110, 124)



Термостат с запорным и переключающим вентилем
(см. стр. 98, 114, 116, 120)



High Flow

High Flow Термостат с запорным вентилем
(см. стр. 140, 146, 148)

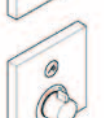

Термостат с запорным вентилем
(см. стр. 104, 106, 110)

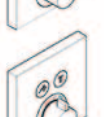

Термостат с запорным вентилем
(см. стр. 98, 114, 116, 120)

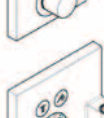

Термостат с запорным вентилем
(см. стр. 100, 112)



ShowerSelect Смеситель душа
(см. стр. 104, 106, 110)



ShowerSelect Смеситель ванны
(см. стр. 98, 114, 116, 120)



iControl
Запорный и переключающий вентиль (см. стр. 150)



ShowerSelect
3 x Запорный клапан (см. стр. 144, 146 - 150, 158)



Raindance Showerpipe
(см. стр. 108)



Raindance Rainfall 240
(см. стр. 140, 142)



Raindance Rainfall 180
(см. стр. 154 - 158)

Raindance E 420
(см. стр. 150, 152)

Raindance Select E 300
(см. стр. 148)

Csőszerelés

Az iBox szimmetrikus rotációjú belső szerelékével együtt univerzálisan – vízszintesen és függőlegesen egyaránt – elhelyezhető. A biztonsági szerelvényvel ellátott kádcsaptelep kivételével, itt csak a függőleges beépítés lehetséges. Mivel a működő részek meghibásodásakor víz kerülhet az iBox-ra, ezért az iBox-ot a kád fölé kell felszerelni, hogy a kifolyó víz a kádba folyhasson!

Az iBox kádhoz és tusolóhoz egyaránt alkalmas. Egykaros kádcsaptelep / elzáró- és váltószeleppel rendelkező termosztát esetében az alsó kiállás az elsődleges. Zuhanycsaptelep szerelése esetén a használaton kívüli kiállást vakdugóval kell lezárni.

A hidegvíz- és a melegvíz-csatlakozások közötti nagy nyomáskülönbséget kikell egyenliteni!

Az alaptestet úgy szereljük be, hogy a melegvíz csatlakozása bal oldalra, míg a hidegvíz csatlakozása jobb oldalra kerüljön.

Beépítési mélység: 80 – 108 mm

Hosszabbítás 25 mm cikkszám 13595000

Hosszabító készlet 22 mm (kis beépítési mélység esetén) cikkszám 13593000 / 13596XXX / 13597XXX / 15597000 / 19427000 / 97407XXX / 98860000

Az alaptestet az építészeti adottságoknak megfelelően szereljük be. A szerelési példákat lásd a 91. és a 92. oldalon.

A Szerelés közvetlenül a falra.

B Tóvtartó szerkezetre való szerelés.

C Tartórendszerre szerelés.

D Szerelés készház-szerelőlapokra vagy kész cellákra.

E Szerelés falba süllyesztve.

F Szerelés szerelősín-szettel #96615000.

Felszerelési példák méreteikkel és vezeték- dimenzionálással az 96 oldaltól kezdődően találhatóak. A használt szimbólumok magyarázatai az 42 és 43 oldalon találhatóak.

A szerelési útmutatóban megadott szerelési méretek kb. 1800 mm testmagasságú személyeknek alkalmasak, és ennek megfelelően átméretezendők. Itt arra kell ügyelni, hogy az átméretezett szerelési magasságnál megváltozik a minimális magasság és figyelembe kell venni a csatlakozó méreteinek változását.

Szerelési ötlet

A csatlakozó közdarabok becsavarásához - egy cső segítséggel - fogjuk satuba az iBox-ot.

Átöblítés

Öblítsük át a teljes szerelvényt a DIN 1988 sz. szabvány előírásainak megfelelően. Az öblítőblokkon látható nyilak mutatják, hogy melyik beömlő vezeték melyik lefolyó vezetékhez kapcsolódik, így pl. a hidegvíz vezetéke az 1. kiálláshoz és a melegvíz vezetéke a 2. kiálláshoz. Amennyiben csupán egyetlen kiállásra van szükség, az első öblítési műveletet követően forgassuk el 90°-kal az öblítő-blokkot.

iBox, valamint Exafill kádtöltő, le- és túlfolyó kombinációja (lásd a 95. oldalon)

Műszaki adatok

Üzemi nyomás:	max. 1 MPa
Ajánlott üzemi nyomás:	0,1 - 0,5 MPa
Nyomáspróba:	1,6 MPa
{ 1 MPa = 10 bar = 147 PSI}	
Forróvíz hőmérséklet:	max. 80 °C
Forróvíz javasolt hőmérséklete:	65 °C
Csatlakozási méret:	G 3/4
Csatlakozás:	hideg jobbra – meleg balra
Szabad átfolyás 0,3 MPa nyomás esetén:	
Kádcsaptelep:	31 l/perc // 24 l/perc
Kádcsaptelep beépített biztonsági egységgel:	
	25 l/perc // 24 l/perc
Zuhanycsaptelep:	32 l/perc
Termosztát:	43 l/perc
Termosztát elzárószeleppel:	26 l/perc
Termosztát elzáró- és váltószeleppel:	26 l/perc
Termosztát High Flow:	58 l/perc
iControl:	30 l/perc

X

A kád közepe / Zuhanytálca közepe



Falsik alatti szelep

Y

Y méret = a csőcsatlakozó közepétől a kádőtöltő befolyócső közepéig, osztva kettővel (szükség esetén a csempé kiosztásához igazítva).



Quattro

Quattro négy-utas átalakító



Melegvíz



Trio

Trio univerzális záró- és váltószelep

Hidegvíz



A • -tól működik az adott funkció.



Kádbevezetés



Ezen a területen a fal megerősítésére van szükség.



A fölösleges kimenetet vakdugóval kell lezárni. (DN 20 3/4")



Egyidejűleg csak egy fogyasztót lehet használni, két fogyasztó (zuhanyrózsa, oldalzuhanyok) egyszerre nem tud működni.



> 50 l/min

A lefolyó teljesítményének 50l/percnél magasabbnak kell lenni



Az oldalzuhanyokhoz a vízvezeték lejtéssel ajánlott beszerezni.



Raindrain

Lefolyó



Öblítőblokk csatlakozó #15956000, a szállítási egység nem tartalmazza



Exafill

iBox, valamint Exafill kádőtöltő, le- és túlfolyó kombinációja (lásd a 95. oldalon)

DVGW



Kádcsaptelep beépített biztonsági egységgel (lásd a oldalon 96)



Zuhanycsaptelep (lásd a oldalon 104, 106, 110, 124)



Kádcsaptelep (lásd a oldalon 98, 102, 114, 116)

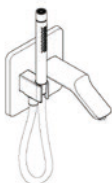

Kádbevezetés (lásd a oldalon 102)



Termosztát
(lásd a oldalon 118, 122, 126)



High Flow

High Flow Termosztát
(lásd a oldalon 128 - 138, 142, 144, 150 - 158)



Termosztát elzárószeleppel
(lásd a oldalon 104, 106, 110, 124)



Termosztát elzáró- és váltószeleppel
(lásd a oldalon 98, 114, 116, 120)



High Flow

High Flow Termosztát elzárószeleppel
(lásd a oldalon 140, 146, 148)

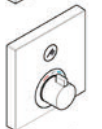

Termosztát elzárószeleppel
(lásd a oldalon 104, 106, 110)



Termosztát elzárószeleppel
(lásd a oldalon 98, 114, 116, 120)



Termosztát elzárószeleppel
(lásd a oldalon 100, 112)



ShowerSelect Zuhanycsaptelep
(lásd a oldalon 104, 106, 110)



ShowerSelect Kádcsaptelep
(lásd a oldalon 98, 114, 116, 120)



iControl
Záró- és váltószelep (lásd a oldalon 150)

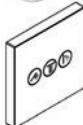

ShowerSelect
3 x Elzárószelep (lásd a oldalon 144, 146 - 150, 158)



Raindance Showerpipe
(lásd a oldalon 108)



Raindance Rainfall 240
(lásd a oldalon 140, 142)

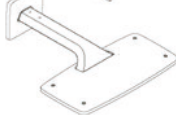

Raindance Rainfall 180
(lásd a oldalon 154 - 158)

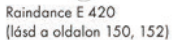

Raindance E 420
(lásd a oldalon 150, 152)

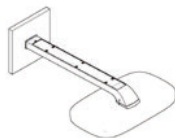

Raindance Select E 300
(lásd a oldalon 148)

Raaka-asennus

Pyörösymmetrinen iBox:in peruskappale on yleiskäyttöinen, sen voi asentaa sekä pysty-, että vaakasuoraan. Poikkeuksena sellaisten ammearmatuurit, joissa on varmuuskombinaatio, tällöin vain vaakasuora asennus on mahdollinen. Koska iBox:ista voi valua vettä toimintaosien vahingoittuessa, iBox on asennettava ammeen yläpuolelle, jotta valuva vesi pääsee valumaan ammeeseen!

iBox soveltuu sekä amme- että myös suihkuasennukseen. Lähtö 1 on tarkoitettu etupäässä yksikösi ammesekoittimelle / sulku- ja vaihtventtiilillä varustetulle termostaatille. Suihkuasennuksessa käyttämättä jäänyt lähtö pitää tiivistää sulkutulpalla.

Suuret paine-erot kylmä- ja kuumavesiliitäntöjen välillä on tasattava.

Asenna peruskappale siten, että lämminvesiliitäntä tulee vasemmalle ja kylmävesiliitäntä aina oikealle puolelle.

Asennussyvyys 80 mm - 108 mm.

Pidennys 25 mm tuotenumero 13595000

Pidennys 22 mm (pienemmällä asennussyvyydellä)
tuotenumero 13593000 / 13596XXX / 13597XXX /
15597000 / 19427000 / 97407XXX / 98860000

Peruskappaleen voi asentaa rakennuksen asettamien reunaehtojen mukaisesti, katso asennusesimerkkejä sivuilla 91 ja 92.

A Asennus seinään

B Asennus seinään. Tässä joustavaa etäisyydenpitintä käyttäen kaksikierteisillä 10 mm ruuveilla.

C Asennus kannatinjärjestelmään

D Asennus valmistalo-asennuslevyille tai valmistiloihin.

E Asennus suoraan seinään.

F Asennus käyttäen asennuskisko-sarjaa #96615000.

Asennusesimerkit mittoineen ja putkietoimeen löytyvät alkaen sivulta 96. Käytettyjen merkien selitys sivulla 45 ja 46.

Asennusohjeessa annetut asennusmitat sopivat n. 180 cm:n pituiselle henkilölle, ja niitä on tarvittaessa muutettava. Tässä on otettava huomioon, että asennuskorkeuden muuttuessa muuttuu myös vähimmäiskorkeus, ja muutos on otettava huomioon liitäntöjen mitoissa.

Asennusvihje

Kiinnitä iBox putkenpätkän avulla ruuvipenkkiin, jotta saat kierrettyä liitinkappaleet sisään.

Huhtelu

Koko asennettu järjestelmä on huuhdeltava DIN 1988 / EN 1717 mukaisesti. Huuhtelulohkossa olevat nuolet osoittavat mikä tulo on liitettyä mihinkin lähtöön, esim. kylmävesi lähtöön 1 ja lämminvesi lähtöön 2. Jos tarvitaan vain 1 lähtö, ensimmäisen huuhtelun jälkeen huuhtelulohkoa on kierrettävä 90°.

iBox yhdessä Exafill ammeentäyttöhana varustettuna tyhjennys- ja ylivuoto-varusteilla (katso sivu 95)

Tekniset tiedot

Käyttöpaine:	maks. 1 MPa
Suosittelut käyttöpaine:	0,1 - 0,5 MPa
Koestuspaine:	1,6 MPa
(1 MPa = 10 bar = 147 PSI)	
Kuuman veden lämpötila:	maks. 80 °C
Kuuman veden suosituslämpötila:	65 °C
Liitäntämitat:	G ¾
Liittimet:	kylmä oikealla - kuuma vasemmalla
Vapaa läpivirtaus 0,3 MPa paineella:	
Ammesekoittaja:	31 l/min // 24 l/min
Ammesekoittaja integroidulla turvayhdistelmällä:	
	25 l/min // 24 l/min
Suihkusekoittaja:	32 l/min
Termostaatti:	43 l/min
Termostaatti sulkuventtiilillä:	26 l/min
Termostaatti sulku- ja vaihtventtiilillä:	26 l/min
Termostaatti High Flow:	58 l/min
iControl:	30 l/min

X Ammeen keskusta / Suihkualtaan keskusta  Upotettava venttiili

Y Mitta Y = etäisyys letkunliitäntäkaaren keskeltä ammeen tuloaukon keskelle jaettuna kahdella (sovitus mahdollisesti laattaruudukkoon).  4-tiesäätöventtiili

 Lämmin vesi

 Kylmä vesi

 Tämä toiminta on taattuna • alkaen.

 Tässä kohdassa seinää on vahvistettava

 Vain yksi vedenkäyttöpiste kerrallaan on mahdollista, ei kahta samanaikaisesti.

 Vie sivusuihkujen syöttöputket alaspäin laskevasti.

 Huuhtelulohko, täyd. #15956000, ei kuulu toimitukseen

 Trio -sulku- ja säätöventtiili

Trio

 Vedentulo ammeeseen

 Käyttämätön lähtöliitin on suljettava sulku-tulpalla. (DN 20 3/4")

 Poisvirtaustehon on oltava enemmän kuin 50l/min.

> 50 l/min

 Veden poisvirtaus

Raindrain

 iBox yhdessä Exafill ammeentäyttöhana varustettuna tyhjennys- ja ylivuotavarusteilla (katso sivu 95)

Exafill

DVGW  Ammesekoittaja integroidulla turvayhdistelmällä (katso sivu 96)

 Suihkusekoittaja (katso sivu 104, 106, 110, 124)

 Ammesekoittaja (katso sivu 98, 102, 114, 116)

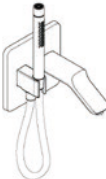
 Vedentulo ammeeseen (katso sivu 102)



Termostaatti
(katso sivu 118, 122, 126)



High Flow

High Flow Termostaatti
(katso sivu 128 - 138, 142, 144, 150 - 158)



Termostaatti sulkuventtiilillä
(katso sivu 104, 106, 110, 124)



Termostaatti sulku- ja vaihtventtiilillä
(katso sivu 98, 114, 116, 120)



High Flow

High Flow Termostaatti sulkuventtiilillä
(katso sivu 140, 146, 148)

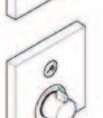

Termostaatti sulkuventtiilillä
(katso sivu 104, 106, 110)

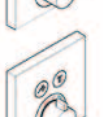

Termostaatti sulkuventtiilillä
(katso sivu 98, 114, 116, 120)

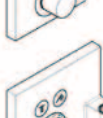

Termostaatti sulkuventtiilillä
(katso sivu 100, 112)



ShowerSelect Suihkusekoittaja
(katso sivu 104, 106, 110)



ShowerSelect Ammesekoittaja
(katso sivu 98, 114, 116, 120)



iControl
Sulku- ja säätöventtiili (katso sivu 150)



ShowerSelect
3 x Sulkuventtiili (katso sivu 144, 146 - 150, 158)



Raindance Showerpipe
(katso sivu 108)



Raindance Rainfall 240
(katso sivu 140, 142)



Raindance Rainfall 180
(katso sivu 154 - 158)



Raindance E 420
(katso sivu 150, 152)



Raindance Select E 300
(katso sivu 148)

Grundmontering

Den rotations-symmetriska grundkonstruktionen hos iBox är universellt användbar, så väl horisontellt som vertikalt. Detta gäller dock inte för monteringen av kararmatur med säkerhetskombination; här är endast vertikal montering möjlig. Eftersom vatten kan tränga ut vid iBoxen om funktionsdelar är defekta så måste iBoxen monteras över karett så att det vatten som kommer ut kan rinna ner i karett!

IBox är avsedd för såväl kar- som duschinstallation. Till enhandsblandare / termostat med spärr- och omställningsventil används främst det undre avloppet. Vid installation i dusch måste man sätta en propp i det avlopp som inte behövs så att detta är tät..

Stora tryckskillnader mellan anslutningarna för varmt och kallt vatten måste utjämnas.

Montera grundkonstruktionen så att varmvattensanslutningen sitter till vänster och kallvattensanslutningen till höger.

Monteringsdjup 80 mm till 108 mm.

Förlängning 25 mm artikelnummer 13595000

Förlängning 22 mm (vid litet monteringsdjup)

artikelnummer 13593000 / 13596XXX / 13597XXX / 15597000 / 19427000 / 97407XXX / 98860000

Grundkonstruktionen monteras enligt de förutsättningar som gäller på platsen, se monteringsexempel på sidor 91 och 92.

A Vägginstallation.

B Vägginstallation. Här med flexibel avståndshållare genom skruvstift storl. 10.

C Montering på stödsystem.

D Installation på monteringsplattor till färdighus eller färdigsektioner.

E Installation direkt i väggen.

F Installation med monteringskeneset #96615000.

Du hittar installationsexempel med uppgifter om mått och ledningsdimensioner från sidan 96. Förklaringen till de använda symbolerna på sidan 48 och 49.

De monteringsmått som anges i monteringsanvisningen passar 1,80 m långa personer och måste eventuellt anpassas. Det är då viktigt att tänka på att den minsta höjden ändras när monteringshöjden blir en annan och att hänsyn måste tas till de ändrade anslutningsmåten.

Monteringstips

Sätt fast iBox i skruvtvingen med hjälp av ett rör när anslutningsstycken ska skruvas in.

Spola

Spola igenom hela installationen enligt DIN 1988 / EN 1717. Pilarna på spolblocket visar vilken inkommande ledning som är ansluten till vilket avlopp, t.ex. kallvatten till avlopp 1 och varmvatten till avlopp 2. Om det bar behövs ett avlopp måste spolblocket vridas 90° efter första spolningen.

iBox i kombination med ett Exafill karinlopp med från- och överrinningsset (se sidan 95)

Tekniska data

Driftstryck:	max. 1 MPa
Rek. driftstryck:	0,1 - 0,5 MPa
Tryck vid provtryckning: (1 MPa = 10 bar = 147 PSI)	1,6 MPa
Varmvattentemperatur:	max. 80 °C
Rek. varmvattentemp.:	65 °C
Anslutningsmått:	G 3/4
Anslutningar:	kallt höger - varmt vänster
Fri genomströmning vid 0,3 MPa:	
Karblandare:	31 l/min // 24 l/min
Karblandare med integrerad säkerhetskombination:	25 l/min // 24 l/min
Duschblandare:	32 l/min
Termostat:	43 l/min
Termostat med spärrventil:	26 l/min
Termostat med spärr- och omställningsventil:	26 l/min
Termostat High Flow:	58 l/min
iControl:	30 l/min

X

Mitt på badkar / Mitten av duschkaret



Invärdig ventil

Y

Mått Y = mitten av slanganslutningskrök till mitten av karinlopp delat med två (anpassa eventuellt till kakelmönstret).



Quattro Fyrvägsomkastare

Quattro



Varmvatten

Kallvatten



Trio Universell avstängningsventil och omkastare

Trio



Från • garanteras funktionen.



Badkarskran



Šioje zonoje būtinas sienos sutvirtinimas



Det utlopp som inte behövs måste tätas med en blindstopp. (DN 20 3/4")



Endast en enhet möjlig, inte två samtidigt.



Avloppet måste klara mer än 50 l/min.

> 50 l/min



Drag vattenledningar till sidoduschar med fall.



Avlopp

Raindrain



Spolblock kompl. #15956000, medföljer ej leveransen



Exafill

iBox i kombination med ett Exafill karinlopp med från- och överrinningsset (se sidan 95)

DVGW



Karblandare med integrerad säkerhetskombination (se sidan 96)



Duschblandare (se sidan 104, 106, 110, 124)



Karblandare (se sidan 98, 102, 114, 116)

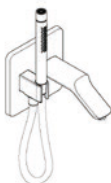

Badkarskran (se sidan 102)



Termostat
(se sidan 118, 122, 126)



High Flow

High Flow Termostat
(se sidan 128 - 138, 142, 144, 150 - 158)



Termostat med spärrventil
(se sidan 104, 106, 110, 124)



Termostat med spärr- och omställningsventil
(se sidan 98, 114, 116, 120)



High Flow

High Flow Termostat med spärrventil
(se sidan 140, 146, 148)

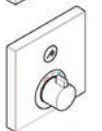

Termostat med spärrventil
(se sidan 104, 106, 110)



Termostat med spärrventil
(se sidan 98, 114, 116, 120)



Termostat med spärrventil
(se sidan 100, 112)



ShowerSelect Duschblandare
(se sidan 104, 106, 110)



ShowerSelect Karblandare
(se sidan 98, 114, 116, 120)



iControl
Avstängningsventil och omkastare (se sidan 150)

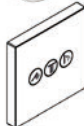

ShowerSelect
3 x Spärrventil (se sidan 144, 146 - 150, 158)



Raindance Showerpipe
(se sidan 108)



Raindance Rainfall 240
(se sidan 140, 142)

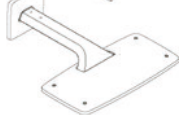

Raindance Rainfall 180
(se sidan 154 - 158)

Raindance E 420
(se sidan 150, 152)

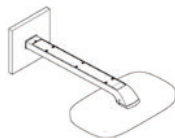

Raindance Select E 300
(se sidan 148)

Bazinis montavimas

Simetriškai besisukantis iBox pagrindą galima įstatyti tiek horizontaliai, tiek vertikaliai. Kai įrengiama vonios armatūra su apsauginiu rinkiniu, įmontuoti galima tik vertikaliai. "iBox" visada montuokite virš vonios, kad atsidarius problemai su funkcinėmis dalimis, vanduo galėtų į ją nubėgti!

iBox tinka tiek voniai, tiek ir dušui. Viena ranka valdomuose maišytuvuose / termostatuose su uždarymo vožtuvais ir skirstytuvais pirmenybė teikiama apatiniam išvadui. Įrengdami dušą, nereikalingą išvadą sandariai uždenkite kaiščiu.

Turi būti išlyginti šalto ir karšto slėgio nelygumai.

Pagrindą sumontuokite taip, kad karšto vandens jungtis būtų kairėje, o šalto - dešinėje.

Montavimo gylis: nuo 80 mm iki 108 mm.

Ilgiklis 25 mm Art.Nr. 13595000

Ilgiklis 22 mm, esant nepakankamam sienos gyliui.

Art.Nr. 13593000 / 13596XXX / 13597XXX / 15597000 / 19427000 / 97407XXX / 98860000

Pagrindą galite sumontuoti pagal vietos sąlygas, montavimo pavyzdžiai pateikti 91 ir 92 psl.

- A** Montavimas į sieną.
- B** Montavimas į sieną su specialiais reguliuojamais 10 mm varžtais.
- C** Montavimas prie laikančios sistemos.
- D** Montavimas ant montavimo plokščių.
- E** Montavimas į sieną.
- F** Montavimas su montavimo rinkiniu #96615000.

Įrengimo pavyzdžiai su nurodytais matmenimis ir vamzdyno dydžiais pateikti 96 puslapyje. Vartojamų simbolių paaiškinimai pateikti 51 ir 52 puslapiuose.

Montavimo instrukcijoje nurodyti išmatavimai idealiai tinka 1800 mm ūgio žmonėms. Galima keisti aukštį, bet tuomet keičiasi minimalus rekomenduojamas patalpos aukštis ir turi būti atsižvelgta į vandens jungties matmenų pasikeitimą.

Montavimo patarimas

Norėdami įsukti jungiamuosius elementus, vamzdžiu įtvirtinkite iBox spaustuvoje.

Išplaukite

Pagal DIN 1988 / EN 1717 išplaukite visą įrangą. Rodyklės ant plaunamojo bloko rodo, kuriuos įvadus ir išvadų vamzdžius reikia sujungti tarpusavyje, pavyzdžiui, 1 šalto vandens išvadą su 2 karšto vandens išvadu. Jei reikalingas tik vienas išvadas, po pirmojo plovimo pasukite plaunamąjį bloką 90°.

iBox kartu su Exafill vonios čiaupu ir išleidimo bei apsauginės angos rinkiniais (žr. psl. 95)

Techniniai duomenys

Darbinis slėgis:	ne daugiau kaip 1 MPa
Rekomenduojamas slėgis:	0,1 - 0,5 MPa
Bandomasis slėgis:	1,6 MPa
(1 MPa = 10 barų = 147 PSI)	
Karšto vandens temperatūra:	ne daugiau kaip 80 °C
Rekomenduojama karšto vandens temperatūra:	65 °C
Atstumas tarp centrų:	G ¾
Prijungimas:	Šaltas vanduo dešinėje, karštas - kairėje
Laisvas vandens pralaidumas esant 0,3 MPa slėgiui:	
maišytuvai voniai:	31 l/min // 24 l/min
maišytuvai voniai su integruota apsaugos sistema:	
	25 l/min // 24 l/min
dušo maišytuvai:	32 l/min
Termostatas:	43 l/min
Termostatas su uždarymo vožtuvu:	26 l/min
Termostatas su uždarymo vožtuvu ir skirstytuvu:	26 l/min
Termostatas High Flow:	58 l/min
iControl:	30 l/min

X

Vonios vidurys / Dušo padėklo centras



Potinkinis uždarymo vožtuvas

Y

Matmuo Y = atstumas nuo dušo žarnos jungties centro iki čiaupo centro, padalintas iš 2 (jei įmanoma, taikykite prie plytelių).



„Quattro“ 4-krypčių perjungimas

Quattro



Šiltas vanduo



Užvarinis ir perjungimo vožtuvas „Trio Universal“

Trio

Šaltas vanduo



Nuo • funkcionavimas garantuotas



Vonios įeiga



Šioje zonoje būtinas sienos sutvirtinimas



Nenaudojamą išėjimą užaklinti. (DN 20 3/4")



Vienu metu galima tik viena funkcija.



Nutekėjimo našumas turi būti ne mažesnis 50 l/min

> 50 l/min



Privesti vamzdžius šoniniams purkštukams.



Nutekėjimas

Raindrain



Plaunamojo bloko jungtis # 15956000, nėra pridedama



iBox kartu su Exafill vonios čiaupu ir išleidimo bei apsauginės angos rinkiniais (žr. psl. 95)

Exafill

DVGW



maišytuvas voniai su integruota apsaugos sistema (žr. psl. 96)



dušo maišytuvas (žr. psl. 104, 106, 110, 124)



maišytuvas voniai (žr. psl. 98, 102, 114, 116)

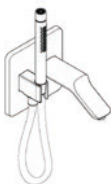

Vonios įeiga (žr. psl. 102)



Termostatas
(žr. psl. 118, 122, 126)



High Flow

High Flow Termostatas
(žr. psl. 128 - 138, 142, 144, 150 - 158)



Termostatas su uždarymo vožtuvu
(žr. psl. 104, 106, 110, 124)



Termostatas su uždarymo vožtuvu ir skirstytuvu
(žr. psl. 98, 114, 116, 120)



High Flow

High Flow Termostatas su uždarymo vožtuvu
(žr. psl. 140, 146, 148)

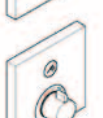

Termostatas su uždarymo vožtuvu
(žr. psl. 104, 106, 110)

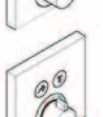

Termostatas su uždarymo vožtuvu
(žr. psl. 98, 114, 116, 120)

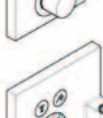

Termostatas su uždarymo vožtuvu
(žr. psl. 100, 112)



ShowerSelect dušo maišytuvas
(žr. psl. 104, 106, 110)



ShowerSelect maišytuvas voniai
(žr. psl. 98, 114, 116, 120)



iControl
Užtvarinis ir perjungimo vožtuvas [žr. psl. 150]



ShowerSelect
3 x Uždarymo vožtuvas (žr. psl. 144, 146 - 150, 158)



Raindance Showerpipe
(žr. psl. 108)



Raindance Rainfall 240
(žr. psl. 140, 142)



Raindance Rainfall 180
(žr. psl. 154 - 158)

Raindance E 420
(žr. psl. 150, 152)

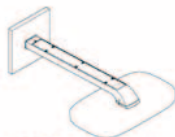

Raindance Select E 300
(žr. psl. 148)

Pripremna montaža

Rotacijsko simetrično tijelo jedinice iBox je univerzalno primjenjivo, kako horizontalno tako i vertikalno. Iznimku predstavlja montaža armatura za kade sa sigurnosnom kombinacijom, kod koje je moguća samo vertikalna ugradnja. Budući da kod kvara pojedinih dijelova iz iBox-a može otjecati voda, iBox je potrebno instalirati iznad kade kako bi voda mogla otjecati u kadul

IBox je pogodan za ugradnju na tuš kade i kade. Kod jednoručnih miješalica za kade / termostat sa ventilom za zatvaranje i ventilom selektora prioritetan je donji izlaz. Kod instalacije na tuš kadi izlaz koji se ne koristi treba završiti čepom.

Velika razlika u pritisku između vruće i hladne vode mora biti izbalansirana.

Montirajte tijelo tako da se priključak tople vode nalazi na lijevoj, a hladne na desnoj strani.

Dubina ugradnje 80 - 108 mm.

Produljenje 25 mm br. Proizvoda 13595000

Produljenje 22 mm (kod manje dubine ugradnje)

br. Proizvoda 13593000 / 13596XXX / 13597XXX / 15597000 / 19427000 / 97407XXX / 98860000

Tijelo se može montirati u skladu s uvjetima koji vladaju na mjestu postavljanja, primjeri montaže mogu se naći na stranicama 91 i 92.

- A** Direktna instalacija u zid.
- B** Direktna instalacija u zid sa 10 mm podesivim vijcima
- C** Montaža na sustav nosača.
- D** Instalacija u montažne ploče
- E** Instalacija u zid od cigle.
- F** Instalacija sa setom instalacijskih udloga #96615000.

Primjeri instalacija s veličinama i dimenzijama vodova mogu se naći od stranice 96 nadalje. Pojašnjenje korištenih simbola nalazi se na stranici 54 i 55.

Montažne dimenzije navedene u uputama za montažu idealne su za osobe visine oko 1800 mm te se prema potrebi moraju prilagoditi konkretnoj visini korisnika. Pritom valja uzeti u obzir da se u slučaju promjene montažne visine mijenja i minimalna visina kao i da se tada mora uvažiti i promjena priključnih dimenzija.

Savjet u vezi montaže

Za uvrtnje priključnih elemenata iBox treba zategnuti u stegu uz pomoć komada cijevi.

Ispiranje

Kompletnu instalaciju treba isprati sukladno DIN 1988 / EN 1717. Strelice na bloku prikazuju koji je dovod spojen s kojim odvodom, npr. hladna voda s odvodom 1, a topla voda s odvodom 2. Ukoliko je potreban samo jedan odvod, onda se nakon prvog ispiranja blok mora zakrenuti za 90°.

iBox u kombinaciji s Exafill ispustom u kadu s odvodnom i prelivnom garniturom (pogledaj stranicu 95)

Tehnički podatci

Najveći dopušteni tlak:	tlak 1 MPa
Preporučeni tlak:	0,1 - 0,5 MPa
Probni tlak:	1,6 MPa
(1 MPa = 10 bar = 147 PSI)	
Temperatura vruće vode:	tlak 80°C
Preporučena temperatura vruće vode:	65°C
Razmak od sredine:	G ¾
Spojevi:	hladna desno - topla lijevo
Slobodan protok na 0,3 MPa:	
Miješalica za kadu:	31 l/min // 24 l/min
Miješalica za kadu sa ugrađenim sigurnosnim sustavom:	
	25 l/min // 24 l/min
Miješalica tuša:	32 l/min
Termostat:	43 l/min
Termostat sa izolacijskim ventilom:	26 l/min
Termostat sa ventilom za zatvaranje i ventilom selektora:	
	26 l/min
Termostat High Flow:	58 l/min
iControl:	30 l/min

X	Sredina kade / Sredina tuš-kada		Podžbukni ventil
Y	Mjera Y = sredina priključka crijeva do sredine filtera kade podijeljeno sa 2 (eventualno prilagoditi rasteru pločica)	 Quattro	Quattro četverostruki preusmjerivač
	Topla voda		Trio Universal ventil za zatvaranje i ventil selektora
	Hladna voda	Trio	
	Zajamčena funkcija od • naviše		Ispust u kadu
	U ovom je području potrebno ojačanje zida.		Potrebno je ostaviti zatvoren izlaz koji se ne koristi (DN 20 3/4")
	Moguće je koristiti samo jedno trošilo, nikako dva istovremeno!		Protok vode mora biti veći od 50 l/min.
	Položite vodovodne cijevi za bočni tuš s nagibom	> 50 l/min	
	kompletni blok #15956000, Nije sadržano u isporuci!	 Raindrain	Odvod
		 Exafill	iBox u kombinaciji s Exafill ispuštom u kadu s odvodnom i prelijevnom garniturom (pogledaj stranicu 95)

	Mješalica za kadu sa ugrađenim sigurnosnim sustavom (pogledaj stranicu 96)
	Mješalica za kadu (pogledaj stranicu 98, 102, 114, 116)

	Mješalica tuša (pogledaj stranicu 104, 106, 110, 124)
	Ispust u kadu (pogledaj stranicu 102)



Termostat
(pogledaj stranicu 118, 122, 126)



High Flow

High Flow Termostat
(pogledaj stranicu 128 - 138, 142, 144, 150 - 158)



Termostat sa izolacijskim ventilom
(pogledaj stranicu 104, 106, 110, 124)



Termostat sa ventilom za zatvaranje i ventilom selektora
(pogledaj stranicu 98, 114, 116, 120)



High Flow

High Flow Termostat sa izolacijskim ventilom
(pogledaj stranicu 140, 146, 148)



Termostat sa izolacijskim ventilom
(pogledaj stranicu 104, 106, 110)



Termostat sa izolacijskim ventilom
(pogledaj stranicu 98, 114, 116, 120)



Termostat sa izolacijskim ventilom
(pogledaj stranicu 100, 112)



ShowerSelect Mješalica tuša
(pogledaj stranicu 104, 106, 110)



ShowerSelect Mješalica za kadu
(pogledaj stranicu 98, 114, 116, 120)



iControl
Ventil za zatvaranje i ventil selektora
(pogledaj stranicu 150)

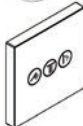

ShowerSelect
3 x zaporni ventil (pogledaj stranicu 144, 146 - 150, 158)



Raindance Showerpipe
(pogledaj stranicu 108)

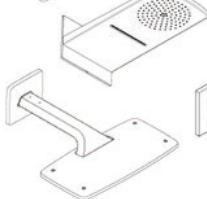

Raindance Rainfall 240
(pogledaj stranicu 140, 142)

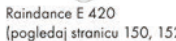

Raindance E 420
(pogledaj stranicu 150, 152)

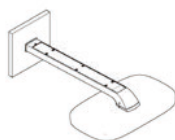

Raindance Select E 300
(pogledaj stranicu 148)

Ham montaj

iBox'un rotasyon simetrik ana gövdesi yatay veya dikey şekilde çok amaçlı kullanılabilir. İstisna: Emniyet kombinasyonlu batarya armatürünün montajı sırasında sadece dikey montaj mümkündür. Fonksiyon parçalarının arızalanması durumunda iBox'tan su çıkabileceği için, dışarı çıkan suyun küvete akabilmesi için iBox küvetin üzerine monte edilmelidir.

iBox hem küvet hem de duş tesisatı için uygundur. Tek elleri küvet tipi bataryalarda /kesme ve divertör valflü termostatta alt çıkış önceliklidir. Duş tesisatında, kullanılmayan çıkış bir tapayla izole edilmelidir.

Sıcak ve soğuk su bağlantıları arasında büyük basınç farklılıkları varsa, bu basınç farklılıklarının dengelemesi gerekir.

Ana gövdeyi, sıcak su bağlantısı solda ve soğuk su bağlantısı sağda olacak şekilde takın.

Montaj derinliği 80 mm ila 108 mm.

Uzatma 25 mm Ürün kodu 13595000

Uzatma 22 mm (montaj derinliği düşükkken)

Ürün kodu 13593000 / 13596XXX / 13597XXX / 15597000 / 19427000 / 97407XXX / 98860000

Ana gövde yapısal koşullara uygun şekilde takılabilir, Montaj örneği Bkz. Sayfa 91 ve 92.

A Duvara direkt montaj

B Duvara direkt montaj. Burada, esnek mesafe tutucuları ile 10'lu sıkma vidaları kullanılarak.

C Taşıyıcı sistem üzerine montaj.

D Hazır ev montaj plakaları ya da hazır hücrelere montaj.

E Tuğla duvar Montajı

F Montaj rayı setiyle montaj #96615000.

Ölçü verileri ve hat boyutlandırıcılığı tesisat örnekleri Sayfa 96 itibarıyla bulunabilir. Kullanılan simgelerin açıklaması Sayfa 57 ve 58'de.

Montaj kılavuzunda belirtilen montaj ölçüleri, yaklaşık 1.800 mm boyundaki kişiler için idealdir ve gerekirse adapte edilmelidir. Bu sırada, montaj yüksekliğinin değişmesiyle birlikte minimum yüksekliğin de değiştiğine ve bağlantı ölçülerindeki değişikliğin göz önüne alınması gerektiğine dikkat edilmelidir.

Montaj önerisi

Bağlantı parçalarını vidalamak için, iBox'u bir boru parçasıyla mengeneyle sabitleyin.

Yıkama

Tüm tesisatı DIN 1988 / EN 1717'ye göre yıkayın.

Yıkama bloğundaki oklar hangi beslemenin hangi çıkış hattına bağlı olduğunu gösterir. Örn; soğuk su 1. çıkış ve sıcak su 2. çıkışa. Sadece bir çıkış kullanılıyorsa, birinci yıkama işleminden sonra yıkama bloğu 90° döndürülmelidir.

Çıkış ve taşma aksesuarlı bir Exafill batarya girişiyle bağlantılı iBox (Bakınız sayfa 95)

Teknik bilgiler

İşletme basıncı:	azami 1 MPa
Tavsiye edilen işletme basıncı:	0,1 - 0,5 MPa
Kontrol basıncı:	1,6 MPa
(1 MPa = 10 bar = 147 PSI)	
Sıcak su sıcaklığı:	azami 80°C
Tavsiye edilen su ısısı:	65°C
Bağlantı ölçüleri:	G ¾
Bağlantılar:	soğuk sağ - sıcak sol
0,3 MPa serbest akış:	
Küvet miks bataryası:	31 l/dak // 24 l/dak
Entegre emniyet kombinasyonlu küvet miks bataryası:	25 l/dak // 24 l/dak
Duş miks bataryası:	32 l/dak
Termostat:	43 l/dak
Kesme valflü termostat:	26 l/dak
Kesme ve divertör valflü termostat:	26 l/dak
Termostat High Flow:	58 l/dak
iControl:	30 l/dak

X

Küvetin ortası / Duş küvetinin ortası



Sıva altı valfi

Y

Y = Hortum bağlantı kavisinin ortasından küvet girişinin ortası arasındaki ölçü 2'ye bölünür (gerekirse fayans bölümlerine adapte edin).



Quattro

Quattro dört yönlü değiştirme



Sıcak su



Trio

Trio üniversal kapatma ve değiştirme valfi

Soğuk su



•den itibaren fonksiyon garanti edilmiştir.



Küvet su girişi



Bu alanda duvarın kalınlaştırılması gereklidir.



Kullanılmayan çıkış bir kör tapayla izole edilmelidir. (DN 20 ¾")



Sadece bir tüketici mümkündür, aynı anda iki tüketici mümkün değildir.



Akış kapasitesi 50 l/dak üzerinde olmalıdır.

> 50 l/min



Yan duşların su hatlarını eğimli şekilde döşeyin.



Akış

Raindrain



Yıkama bloğu komple #15956000, Teslimat kapsamına dahil değildir



Exafill

Çıkış ve taşma aksesuarı bir Exafill batarya girişiyle bağlantılı iBox (Bakınız sayfa 95)

DVGW



Entegre emniyet kombinasyonlu küvet miks bataryası (bakınız sayfa 96)



Duş miks bataryası (bakınız sayfa 104, 106, 110, 124)



Küvet miks bataryası (bakınız sayfa 98, 102, 114, 116)

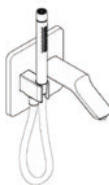

Küvet su girişi (bakınız sayfa 102)



Termostat
(bakınız sayfa 118, 122, 126)



High Flow Termostat
(bakınız sayfa 128 - 138, 142, 144, 150 - 158)



Kesme valfli termostat
(bakınız sayfa 104, 106, 110, 124)



Kesme ve divertör valfli termostat
(bakınız sayfa 98, 114, 116, 120)



High Flow Kesme valfli termostat
(bakınız sayfa 140, 146, 148)



Kesme valfli termostat
(bakınız sayfa 104, 106, 110)



Kesme valfli termostat
(bakınız sayfa 98, 114, 116, 120)



Kesme valfli termostat
(bakınız sayfa 100, 112)



ShowerSelect Duş miks bataryası
(bakınız sayfa 104, 106, 110)



ShowerSelect Küvet miks bataryası
(bakınız sayfa 98, 114, 116, 120)



iControl
Kapatma ve değiştirme valfi (bakınız sayfa 150)

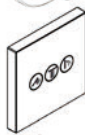

ShowerSelect
3 x Kesme valfli (bakınız sayfa 144, 146 - 150, 158)



Raindance Showerpipe
(bakınız sayfa 108)

Raindance Rainfall 240
(bakınız sayfa 140, 142)

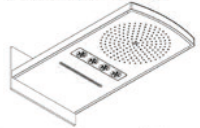

Raindance Rainfall 180
(bakınız sayfa 154 - 158)

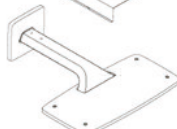

Raindance E 420
(bakınız sayfa 150, 152)

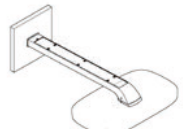

Raindance Select E 300
(bakınız sayfa 148)

Instalare brută

Partea principală simetric-rotatională a iBox-ului poate fi introdusă oricum, atât orizontal cât și vertical. Excepție la montarea robinetului căzii cu combinația de protecție, în acest caz este posibilă numai montarea pe verticală. Din cauza posibilității de defectare a componentelor din iBox, montați instalația iBox deasupra căzii pentru ca apa scursă să se evacueze prin cadă.

Cutia iBox este corespunzătoare atât pentru instalarea cadrelor cât și a dușurilor. În cazul amestecătorului monomanual pentru cadă / termostat cu ventil de închidere și valvă comutator, este prioritară ieșirea inferioară. La instalarea dușului ieșirea nefolosită trebuie etanșată cu o garnitură de etanșare.

Diferențele de presiune mari între alimentarea cu apă rece și apă caldă trebuie echilibrate.

Corpul de bază este astfel construit încât racordul pentru apa caldă se află în partea stângă, iar cel pentru apa rece, în dreapta.

Adâncime de montare 80 - 108 mm

Prelungitor 25 mm Nr. produs 13595000

Prelungitor 22 mm (în cazul montării la adâncime mică)

Nr. produs 13593000 / 13596XXX / 13597XXX / 15597000 / 19427000 / 97407XXX / 98860000

Corpul de bază se poate monta în funcție de condițiile existente, ca exemplu de montare, vedeți pagina 91 și 92.

A Montare pe perete.

B Montare pe perete. Cu distanțieri flexibili și țije filetate de 10 mm cu diblu.

C Montare pe sistem de susținere.

D Montare pe plăci de montare prefabricate sau celule prefabricate.

E Montare direct pe perete.

F Montare cu set de șine de montare #96615000.

Exemplele de montaj cu specificații referitoare la dimensiuni și capacități se găsesc începând de la pagina 96. Explicațiile simbolurilor utilizate se găsesc la paginile 60 și 61.

Dimensiunile de montare din instrucțiunile de montare sunt ideale pentru persoane cu o înălțime de cca. 1800 mm și trebuie modificate dacă este cazul. Aici trebuie să țineți cont de modificarea înălțimii de montare, deoarece în acest caz se va modifica și înălțimea minimă de montare și astfel trebuie modificate toate dimensiunile de racordare.

Indicații pentru montaj

Pentru înșurubarea piesei de racordare, cutia iBox este prevăzută cu o piesă tubulară strânsă în locașul filetat.

Clătire

Toată instalația se spală în conformitate prevederile DIN 1988 / EN 1717. Săgețile de pe blocul de spălare, arată cum se face racordarea la conducta de ieșire, spre ex. apa rece cu ieșirea 1 și apa caldă cu ieșirea 2. În cazul în care este utilizată numai o ieșire, după prima spălare blocul de spălare trebuie rotit cu 90°.

Cutie iBox în combinație cu Exafill pe intrarea în cadă, cu un set pentru evacuare și deversare. (vezi pag. 95)

Date tehnice

Presiune de funcționare:	max. 1 MPa
Presiune de funcționare recomandată:	0,1 - 0,5 MPa
Presiune de verificare:	1,6 MPa
(1 MPa = 10 bar = 147 PSI)	
Temperatura apei calde:	max. 80°C
Temperatura recomandată a apei calde:	65°C
Interax racorduri:	G ¾
Racorduri:	rece - dreapta / cald - stânga
Debit cu curgere liberă la 0,3 MPa:	
baterie pentru cadă de baie:	31 l/min // 24 l/min
Baterie pentru cadă de baie cu combinație de siguranță integrată:	25 l/min // 24 l/min
Baterie duș:	32 l/min
Termostat:	43 l/min
Termostat cu ventil de închidere:	26 l/min
Termostat cu ventil de închidere și valvă comutator:	26 l/min
Termostat High Flow:	58 l/min
iControl:	30 l/min

X

Cadă de baie în mijloc / În mijlocul căzii de duș



Ventil montat sub tencuială

Y

Dimensiune Y = distanța între mijlocul racordului pentru furtună și intrare cadă împărțită la doi (eventual potrivit la suprafața tencuiei).



Quattro

Quattro valvă de inversare cu patru căi



Apă caldă

Apă rece



Trio

Trio valvă de închidere și de inversare universală



Începând de la • funcționarea este garantată.



Gură de admisiune



În această zonă este nevoie de întărirea peretelui.



Racordurile neutilizate trebuie acoperite cu dop etanș. (DN 20 3/4")



Se poate conecta numai un singur consumator, nu se pot conecta doi în același timp.



> 50 l/min

Capacitatea de evacuare trebuie să fie mai mare de 50 l/min.



Montați conductele de apă înclinate (în cădere) pentru dușurile laterale.



Raindrain

Deversor



Complet spălare #15956000, nu este inclus în setul livrat



Exafill

Cutie iBox în combinație cu Exafill pe intrarea în cadă, cu un set pentru evacuare și deversare. (vezi pag. 95)

DVGW



Baterie pentru cadă de baie cu combinație de siguranță integrată (vezi pag. 96)



Baterie duș (vezi pag. 104, 106, 110, 124)



baterie pentru cadă de baie (vezi pag. 98, 102, 114, 116)

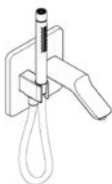

Gură de admisiune (vezi pag. 102)



Termostat
(vezi pag. 118, 122, 126)



High Flow Termostat
(vezi pag. 128 - 138, 142, 144, 150 - 158)



Termostat cu ventil de închidere
(vezi pag. 104, 106, 110, 124)



Termostat cu ventil de închidere și
valvă comutator
(vezi pag. 98, 114, 116, 120)



High Flow Termostat cu ventil de
închidere
(vezi pag. 140, 146, 148)



Termostat cu ventil de închidere
(vezi pag. 104, 106, 110)



Termostat cu ventil de închidere
(vezi pag. 98, 114, 116, 120)



Termostat cu ventil de închidere
(vezi pag. 100, 112)



ShowerSelect Baterie duș
(vezi pag. 104, 106, 110)



ShowerSelect baterie pentru cadă de
baie
(vezi pag. 98, 114, 116, 120)



iControl
Valvă de închidere și de inversare
(vezi pag. 150)

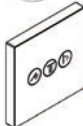

ShowerSelect
3 x Ventil de închidere (vezi pag. 144,
146 - 150, 158)



Raindance Showerpipe
(vezi pag. 108)



Raindance Rainfall 240
(vezi pag. 140, 142)



Raindance Rainfall 180
(vezi pag. 154 - 158)

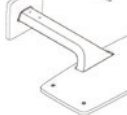

Raindance E 420
(vezi pag. 150, 152)

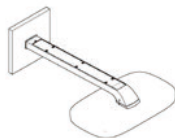

Raindance Select E 300
(vezi pag. 148)

Εγκατάσταση

Το συμμετρικό σώμα περιστροφής του iBox μπορεί να χρησιμοποιηθεί παντού, οριζόντια και κατακόρυφα. Εξαιρείται η συναρμολόγηση της μπαταρίας μπανιέρας με συνδυασμό ασφαλείας, εδώ είναι εφικτή μόνο η κατακόρυφη εγκατάσταση. Σε περίπτωση βλάβης των λειτουργικών τμημάτων, μπορεί να εξέρχεται νερό από το iBox, και θα πρέπει η μονάδα iBox να συναρμολογηθεί πάνω από την μπανιέρα, προκειμένου το εξερχόμενο νερό να ρέει μέσα στην μπανιέρα στην περίπτωση αυτή.

Το iBox είναι κατάλληλο για εγκατάσταση τόσο σε μπανιέρες όσο και σε ντουζιέρες. Σε αναμικτήρες μπανιέρας με μία λαβή / θερμοστάτης με βαλβίδα κλεισίματος και εκτροπής, προτεραιότητα έχει η κάτω εξαγωγή. Σε εγκατάσταση σε ντουζιέρες η εξαγωγή που δεν θα χρησιμοποιείται πρέπει να ταπώνεται με τάπα.

Οι διαφορές της πίεσης μεταξύ της σύνδεσης κρύου και ζεστού νερού θα πρέπει να αντισταθμίζονται.

Τοποθετήστε τη βασική εγκατάσταση έτσι ώστε η σύνδεση ζεστού νερού να βρίσκεται αριστερά και του ψυχρού δεξιά.

Βάθος τοποθέτησης 80 -108 mm.

Επιμήκυνση 25 mm αρ. είδους 13595000

Σωλήνας επιμήκυνσης 22 mm (σε μειωμένο βάθος τοποθέτησης)

αρ. είδους 13593000 / 13596XXX / 13597XXX / 15597000 / 19427000 / 97407XXX / 98860000

Η βασική εγκατάσταση μπορεί να τοποθετηθεί σύμφωνα με τα δεδομένα του χώρου, παραδείγματα εγκατάστασης βλέπε σελίδα 91 και 92.

A Επίτοιχη τοποθέτηση

B Επίτοιχη εγκατάσταση. Χρησιμοποιήστε 10άρες βίδες κορφιά με εύκαμπτα στηρίγματα.

C Συναρμολόγηση επί φέροντος συστήματος.

D Εγκατάσταση σε προκατασκευασμένες σανίδες ή σε προκάτ κελιά.

E Εγκατάσταση απευθείας στον τοίχο

F Εγκατάσταση σε σετ σιδηροτροχιών συναρμολόγησης #96615000.

Παραδείγματα εγκατάστασης με διαστάσεις και διαστασιολόγηση των σωλήνων θα βρείτε από τη σελίδα 96.

Επεξήγηση των χρησιμοποιούμενων εικονιδίων θα βρείτε στη σελίδα 63 και 64.

Οι διαστάσεις που αναφέρονται στις οδηγίες συναρμολόγησης είναι ιδανικές για άτομα με ύψος περ. 1800 mm και πρέπει, εάν χρειαστεί, να προσαρμοστούν. Στη φάση αυτή προσέξτε ότι με την αλλαγή του ύψους συναρμολόγησης τροποποιείται και το απαιτούμενο ελάχιστο ύψος, οπότε θα προκύψει αλλαγή και στις διαστάσεις σύνδεσης.

Συμβουλή για την εγκατάσταση

Για να βιδώσετε τεμάχια σύνδεσης, σφίξτε το iBox με ένα τεμάχιο σωλήνα στη μέγγενη.

Καθαρισμός

Ξεπλύνετε όλη την εγκατάσταση σύμφωνα με το DIN 1988 / EN 1717. Τα βέλη στο μπλοκ ξεπλύματος δείχνουν ποια παροχή συνδέεται με ποιο σωλήνα εξόδου, π.χ. κρύο νερό με έξοδο 1 και ζεστό νερό με έξοδο 2. Εάν χρειάζεται μόνο μία έξοδος, μετά την πρώτη διαδικασία ξεπλύματος, το μπλοκ ξεπλύματος πρέπει να γυρίσει κατά 90°

iBox σε συνδυασμό με είσοδο νερού μπανιέρας Exafill με απορροή και εξοπλισμό υπερχειλίσσης (βλ. σελίδα 95)

Τεχνικά Χαρακτηριστικά

Λειτουργία πίεσης:	έως 1 MPa
Συνιστώμενη λειτουργία πίεσης:	0,1 - 0,5 MPa
Πίση ελέγχου:	1,6 MPa
[1 MPa = 10 bar = 147 PSI]	
Θερμοκρασία ζεστού νερού:	έως 80°C
Συνιστώμενη θερμοκρασία ζεστού νερού:	65°C
Διαστάσεις σύνδεσης:	G ¾
Συνδέσεις:	κρύο δεξιά - ζεστό αριστερά
Ελεύθερη ροή στα 0,3 MPa:	
Μπαταρία μπανιέρας:	31 l/min // 24 l/min
Μπαταρία μπανιέρας με ενσωματωμένο συνδυασμό ασφαλείας:	
	25 l/min // 24 l/min
Μπαταρία (μείκτης) καταιονιστήρα:	32 l/min
Θερμοστάτης:	43 l/min
Θερμοστάτης με βαλβίδα κλεισίματος:	26 l/min
Θερμοστάτης με βαλβίδα κλεισίματος και εκτροπής:	26 l/min
Θερμοστάτης High Flow:	58 l/min
iControl:	30 l/min

X

Κέντρο μανιέρας / Μέσον της ντουσιέρας



Χωνευτή βαλβίδα

Y

Μέγεθος X = από το μέσον του τόξου σύνδεσης του είκαμπου αλμίνα έως το μέσον της βούδου της μανιέρας, δια του 2 (ενδοχομένως να πρέπει να προσαρμοστεί στο ράστερ των πλακιδίων).



Quattro τετράοδης μετατροπής

Quattro



Ζεστό νερό



Trio Universal βαλβίδα κλεισίματος και εκτροπής

Κρύο νερό

Trio



Αυτή η λειτουργία διασφαλίζεται από το σημείο κι έπειτα



Είσοδος νερού στη μανιέρα



Σε αυτήν την περιοχή είναι απαραίτητη μία ενίσχυση του τοίχου.



Τα περιττά στόμια εξόδου πρέπει να στεγανοποιηθούν με ένα τυφλό πώμα. (DN 20 3/4")



Μόνο ένας χρήστης, όχι δύο ταυτόχρονα



Η αποχετευτική ικανότητα της βαλβίδας εκροής πρέπει να υπερβαίνει τα 1/min.

> 50 l/min



Εγκαταστήστε τους αγωγούς νερού του καταιονιστήρα σώματος με κλίση.



Βαλβίδα εκροής

Raindrain



Μπλοκ ζεπλύματος κομπλέ # 15956000, δεν περιλαμβάνεται στον παραδοτέο εξοπλισμό



ίβος σε συνδυασμό με είσοδο νερού μανιέρας Exafill με απορροή και εξοπλισμό υπερχειλίσας (βλ. σελίδα 95)

Exafill

DN6W



Μπαταρία μανιέρας με ενσωματωμένο συνδυασμό ασφαλείας (βλ. Σελίδα 96)



Μπαταρία (μείκτης) καταιονιστήρα (βλ. Σελίδα 104, 106, 110, 124)



Μπαταρία μανιέρας (βλ. Σελίδα 98, 102, 114, 116)

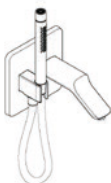

Είσοδος νερού στη μανιέρα (βλ. Σελίδα 102)



Θερμοστάτης
(βλ. Σελίδα 118, 122, 126)



High Flow

High Flow Θερμοστάτης
(βλ. Σελίδα 128 - 138, 142, 144, 150 - 158)



Θερμοστάτης με βαλβίδα κλεισίματος
(βλ. Σελίδα 104, 106, 110, 124)



Θερμοστάτης με βαλβίδα κλεισίματος και εκτροπής
(βλ. Σελίδα 98, 114, 116, 120)



High Flow

High Flow Θερμοστάτης με βαλβίδα κλεισίματος
(βλ. Σελίδα 140, 146, 148)

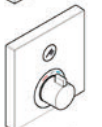

Θερμοστάτης με βαλβίδα κλεισίματος
(βλ. Σελίδα 104, 106, 110)



Θερμοστάτης με βαλβίδα κλεισίματος
(βλ. Σελίδα 98, 114, 116, 120)



Θερμοστάτης με βαλβίδα κλεισίματος
(βλ. Σελίδα 100, 112)



ShowerSelect Μπαταρία (μείκτης) καταιονιστήρα
(βλ. Σελίδα 104, 106, 110)



ShowerSelect Μπαταρία μπανιέρας
(βλ. Σελίδα 98, 114, 116, 120)



iControl Βαλβίδα κλεισίματος και εκτροπής (βλ. Σελίδα 150)

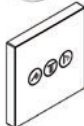

ShowerSelect 3 x Βαλβίδα κλεισίματος (βλ. Σελίδα 144, 146 - 150, 158)



Raindance Showerpipe
(βλ. Σελίδα 108)



Raindance Rainfall 240
(βλ. Σελίδα 140, 142)



Raindance Rainfall 180
(βλ. Σελίδα 154 - 158)



Raindance E 420
(βλ. Σελίδα 150, 152)

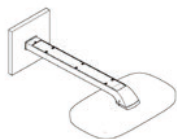

Raindance Select E 300
(βλ. Σελίδα 148)

Surova montaža

Rotacijsko simetrično osnovno telo valja iBox je univerzalno vstavljivo, tako vodoravno kot tudi navpično. Izjema je le montaža armature za kopalno kad z zaščitnim kompleksom, kjer je možna le navpična vgradnja. Pri okvari delov iBoxa lahko pride do izteka vode, zato iBox montiramo nad kadjo. Tako lahko voda odteka v kad!

iBox je primeren tako za instalacije za kopalne kadi kot tudi za prhe. Pri enoročnih baterijah za kopalno kad / termostatu z zapornim in preklopnim ventilom ima prednost spodnji odvod. Pri instalaciji prhe je treba neuporabljen odvod zatesniti s čepom.

Velike razlike v tlaku med priključkom za mrzlo in priključkom za toplo vodo je potrebno izravnati.

Osnovno telo vgradite tako, da se priključek za toplo vodo nahaja na levi, priključek za hladno vodo pa na desni strani.

Globina vgradnje 80 do 108 mm

Podaljšek 25 mm številka artikla 13595000

Podaljšek 22 mm (če zid ni dovolj globok)

številka artikla 13593000 / 13596XXX / 13597XXX / 15597000 / 19427000 / 97407XXX / 98860000

Osnovno telo se lahko montira ustrezno gradbenim pogojem, montažne primere glejte na strani 91 in 92.

A Montaža na steno

B Montaža na steno. Tukaj z upogljivim distančnikom in 10-milimetrskimi vijaki.

C Montaža na nosilnem sistemu.

D Montaža na montažne plošče

E Montaža direktno v steno

F Montaža s pritrilnim kompletom #96615000.

Inštalacijske primere z navedbami mer in dimenzioniranjem cevi najdete od strani 96 dalje. Razlage uporabljenih simbolov na straneh 66 in 67.

V navodilu za montažo navedene mere so idealne za osebe, visoke pribl. 1800 mm, in jih je treba po potrebi prilagoditi. Pri tem morate paziti na to, da se pri spremenjeni montažni višini spremeni tudi minimalna višina in je treba upoštevati spremembo priključnih mer.

Nasvet za montažo

Za uvitje priključnih kosov iBox s pomočjo kosa cevi vpnite v primež.















Izpiranje

Kompletno instalacijo splaknite v skladu z DIN 1988 / EN 1717. Puščice na ventilu za vodo kažejo, kateri dovod je povezan s katerim odvodom, npr. mrzla voda z odvodom 1 in toplá voda z odvodom 2. Če je potreben le en odvod, se mora po prvem splakovanju ventil za vodo obrniti za 90°.

iBox v kombinaciji z Exafill dovodom za kopalno kad z odtočno in pretočno garnituro (glejte stran 95)

Tehnični podatki

Delovni tlak:	maks. 1 MPa
Priporočeni delovni tlak:	0,1 - 0,5 MPa
Preskusni tlak:	1,6 MPa
{ 1 MPa = 10 bar = 147 PSI}	
Temperatura tople vode:	maks. 80°C
Priporočena temperatura tople vode:	65°C
Razdalja od sredine:	G ¾
Priključki:	mrzla desno - toplá levo
Prost pretok pri 0,3 MPa:	
Mešalna baterija za kad:	31 l/min // 24 l/min
Mešalna baterija za kad z vgrajeno varnostno kombinacijo:	25 l/min // 24 l/min
Mešalna baterija za prho:	32 l/min
Termostat:	43 l/min
Termostat z zapornim ventilom:	26 l/min
Termostat z zapornim in preklopnim ventilom:	26 l/min
Termostat High Flow:	58 l/min
iControl:	30 l/min

X	Sredina kopalne kadi / Sredina pršne kadi		Podometni ventil
Y	Mera Y = sredina loka priključka za cev do sredine dotoka v kad deljeno z 2 (morebiti prilagoditi vzorcu ploščic)		Quattro ütiripotna prestavitev
	Topla voda		Trio Universal zaporni in preklopni ventil
	Mrzla voda	Trio	
	Od • je delovanje zagotovljeno.		Vtok v kad
	V tem območju je potrebno ojačanje stene.		Izhod, ki ga ne potrebujete, zatesnite s čepom. (DN 20 3/4")
	Mogoč je samo en uporabnik, ne dva istočasno.		Odtočna kapacitetamora znašati več kot 50 l/min.
	Položite vodovodne cevi za stranske žobe z naklonom.	> 50 l/min	Odtok
	Ventil za vodo, kpl. #15956000, Ni vključeno		Raindrain iBox v kombinaciji z Exafill dovodom za kopalno kad z odtočno in pretočno garnituro (glejte stran 95)

DVGW

 Mešalna baterija za kad z vgrajeno varnostno kombinacijo (glejte stran 96)

 Mešalna baterija za kad (glejte stran 98, 102, 114, 116)

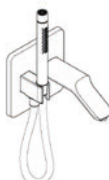
 Mešalna baterija za prho (glejte stran 104, 106, 110, 124)

 Vtok v kad (glejte stran 102)



Termostat
(glejte stran 118, 122, 126)



High Flow Termostat
(glejte stran 128 - 138, 142, 144, 150 - 158)



Termostat z zapornim ventilom
(glejte stran 104, 106, 110, 124)



Termostat z zapornim in preklopnim ventilom
(glejte stran 98, 114, 116, 120)



High Flow Termostat z zapornim ventilom
(glejte stran 140, 146, 148)



Termostat z zapornim ventilom
(glejte stran 104, 106, 110)



Termostat z zapornim ventilom
(glejte stran 98, 114, 116, 120)



Termostat z zapornim ventilom
(glejte stran 100, 112)



ShowerSelect Mešalna baterija za prho
(glejte stran 104, 106, 110)



ShowerSelect Mešalna baterija za kad
(glejte stran 98, 114, 116, 120)



iControl
Zaporni in preklopnji ventil (glejte stran 150)

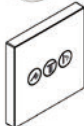

ShowerSelect
3 x Zaporni ventil (glejte stran 144, 146 - 150, 158)



Raindance Showerpipe
(glejte stran 108)

Raindance Rainfall 240
(glejte stran 140, 142)

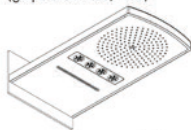

Raindance Rainfall 180
(glejte stran 154 - 158)

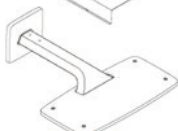
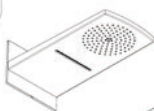

Raindance E 420
(glejte stran 150, 152)

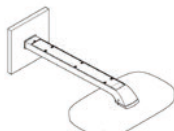

Raindance Select E 300
(glejte stran 148)

Toormontaaž

Iboxi sümmeetrilise ringlusega põhikorpus on universaalselt kasutatav, nii horisontaalselt kui vertikaalselt. V.a. turvakombinatsiooniga vanniarmaatuuri paigaldamisel, kus on võimalik ainult vertikaalne paigaldamine. Paigaldage iBox alati vanni kohale. Kui iBox'i osad lähevad katki, võib vesi vanni voolatala.

iBox sobib niihästi vanni kui ka duši paigaldamiseks. Ühekäe-vannisegisti / katkestus- ja ümberlülitusklapiga termostaat puhul on alumine väljavool prioriteetne. Duši paigaldamisel tuleb mittevajalik väljavool korgiga tihendada.

Kui külma ja kuumu vee ühenduste surve on väga erinev, tuleb need tasakaalustada.

Põhikorpus paigaldada nii, et sooja vee liitmik oleks vasakul ja külma vee liitmik paremal.

Paigalduse sügavus 80 mm kuni 108 mm
pikendus 25 mm artikli number 13595000

pikendus 22 mm (kui sein ei ole piisavalt paks).

artikli number 13593000 / 13596XXX / 13597XXX /
15597000 / 19427000 / 97407XXX / 98860000

Põhikorpus on võimalik paigaldada vastavalt ehituslikele asjaoludele, näiteid paigaldamise kohta vt lk 91 ja 92.

- A** Seinale paigaldamine.
- B** Seinale paigaldamine. Siin reguleeritava vahehoidikuga, kasutades 10 mm rikkpolte.
- C** Kandursüsteemile paigaldamine.
- D** Paigaldamine kiirmontaažiplaatile või valmiskabiini.
- E** Paigaldamine otse seinale.
- F** Paigaldamine kinnitussiinidega #96615000.

Paigaldusnäited koos mõõtude info ja voolikute suurustega leiata alates leheküljelt 96. Kasutatud sümbolite selgitused leiata lehekülgedelt 69 ja 70.

Paigaldusjuhendis esitatud paigaldusmõõdud on ideaalsed u. 1800 mm pikkustele inimestele ning vajadusel tuleb neid kohandada. Seejuures tuleb silmas pidada, et muutunud paigalduskõrguse korral muutub ka minimaalne kõrgus ning tuleb arvestada, et erinevad on ka ühendusmõõdud.

Paigaldusnäpunäide

Ühendusdetailide sissekeeramiseks kinnitage iBox toru abil krustangidesse.

Äravoolu süsteem

Pärast paigaldamist vastavalt standardile DIN 1988 / EN 1717 läbi pesta. Loputusploklil olevad nooled näitavad, milline pealevool on millise äravoolutoruga seotud, nt külm vesi äravooluga 1 ja soe vesi äravooluga 2. Kui on vaja ainult ühte äravoolu, tuleb loputusplokki pärast esimest loputust 90° keerata.

iBox ühenduses ära- ja ülevoolugarnituuriga Exafilli vanni sissevooluga (vt lk 95)

Tehnilised andmed

Töörõhk	maks. 1 MPa
Soovitav töörõhk:	0,1 - 0,5 MPa
Kontrollsurve:	1,6 MPa
(1 MPa = 10 baari = 147 PSI)	
Kuumu vee temperatuur:	maks. 80°C
Soovitav kuumu vee temperatuur:	65°C
distants keskelt:	G ¾
ühendused:	külm paremal, kuum vasakul
Äravoolu surve 0,3 MPa	
Vanni-duši segisti:	31 l/min // 24 l/min
Turvasüsteemiga vanni-duši segisti:	25 l/min // 24 l/min
dušisegisti:	32 l/min
Termostaat:	43 l/min
Katkestusklapiga termostaat:	26 l/min
Katkestus- ja ümberlülitusklapiga termostaat:	26 l/min
Termostaat High Flow:	58 l/min
iControl:	30 l/min

X

Vanni keskoht / Dušivanni kese



peiteklapp

Y

Mõõt Y = vooliku seinaväljavoolu keskmest vannitüüri keskele jagatud 2-ga (võimalusel kohandage keraamiliste plaatide asetusega).



Quattro-liitmik

Quattro



Soe vesi

Külm vesi



Katkestus- ja ümberlülituskapp Trio Universal

Trio



Alates • on funktsioneerimine garanteeritud



Vanni kraan



Selles alas tuleb seinatugevdada.



Mittevajalik väljavool tuleb sulgeda korkiga. (DN 20 3/4")



Võimalik on ainult üks funktsioon, mitte kaks korraga.



Äravoolu jõudlus peab olema suurem kui 50 l/min.

> 50 l/min



Paigaldage kehaduši jaoks vajalikud veetorud kaldega.



Äravooll

Raindrain



Loputusplokk kpl. #15956000, ei sisaldu komplektis



iBox ühenduses ära- ja ülevoolugarnituuriga Exafilli vanni sissevooluga (vt lk 95)

Exafill

DVGW



Turvasüsteemiga vanni-duši segisti (vt lk 96)



dušisegisti (vt lk 104, 106, 110, 124)



Vanni-duši segisti (vt lk 98, 102, 114, 116)

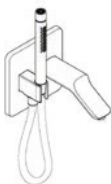

Vanni kraan (vt lk 102)



Termostaat
(vt lk 118, 122, 126)



High Flow

High Flow Termostaat
(vt lk 128 - 138, 142, 144, 150 - 158)



Katkestusklapiga termostaat
(vt lk 104, 106, 110, 124)



Katkestus- ja ümberlülitusklapiga termostaat
(vt lk 98, 114, 116, 120)



High Flow

High Flow Katkestusklapiga termostaat
(vt lk 140, 146, 148)

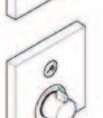

Katkestusklapiga termostaat
(vt lk 104, 106, 110)

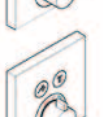

Katkestusklapiga termostaat
(vt lk 98, 114, 116, 120)

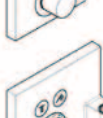

Katkestusklapiga termostaat
(vt lk 100, 112)



ShowerSelect dušisegisti
(vt lk 104, 106, 110)



ShowerSelect Vanni-duši segisti
(vt lk 98, 114, 116, 120)



iControl
Katkestus- ja ümberlülitusklapp (vt lk 150)



ShowerSelect
3 x tõkestus klapp (vt lk 144, 146 - 150, 158)



Raindance Showerpipe
(vt lk 108)



Raindance Rainfall 240
(vt lk 140, 142)



Raindance Rainfall 180
(vt lk 154 - 158)



Raindance E 420
(vt lk 150, 152)

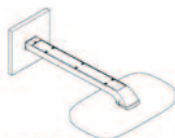

Raindance Select E 300
(vt lk 148)

Cauruļu montāža

Rotācijā simetriskais iBox korpusi ir izmantojams universāli - gan horizontāli, gan vertikāli. Izņemot gadījumus, kad veic vannas armatūras montāžu ar drošības kombināciju - šādos gadījumos iespējama tikai vertikāla iebūve. Tā kā funkcionālo detaļu bojājuma gadījumā no iBox daļas var izplūst ūdens, iBox jāmontē virs vannas, lai izplūstošais ūdens varētu notecēt vannā!

iBox ir piemērots gan vannu, gan dušu instalācijām. Vannas jaucekļkrāniem ar vienu / Termostats ar noslēgvārstu un pārslēdzējvārstu, rokturi opakšējai izplūdei ir prioritāte. Instalējot dušu, nevajadzīgā izplūde jānoblīvē ar aizbāzni.

Jāizlīdzina spiediena atšķirības starp aukstā un karstā ūdens pievadiem.

Korpusu iebūvējiet tā, lai siltā ūdens pieslēgums atrastos pa kreisi un aukstā ūdens pieslēgums - pa labi.

Iebūvēšanas dziļums 80 mm līdz 108 mm.

Pagarinājums 25 mm artikula numurs 13595000

Pagarinājums 22 mm (ja iebūvēšanas dziļums nav pietiekams)

artikula numurs 13593000 / 13596XXX / 13597XXX / 15597000 / 19427000 / 97407XXX / 98860000

Korpusu iespējams iebūvēt atbilstoši konstrukcijas īpašībām, montāžas piemērus skat. 91. un 92. lpp.

A Instalācija pie sienas.

B Instalācija pie sienas. Šeit ar elastīgu starpliku un 10 mm izmēra montāžas skrūvēm.

C Montāža uz balstu sistēmu.

D Instalācija uz gataviem montāžas paneļiem vai gataviem elementiem.

E Instalācija tieši sienā.

F Instalācija ar montāžas sliežu komplektu #96615000.

Uzstādīšanas piemēri ar izmēriem un vadu izkārtojumu atrodami, sākot no 96 lappuses. Lietoto simbolu izskaidrojums atrodams 72 un 73 lappusē.

Montāžas instrukcijās dotie montāžas izmēri ir ideāli piemēroti personām, kuru augums ir apm. 1800 mm. Nepieciešamības gadījumā šie izmēri ir jāpielāgo. Šeit ir jāņem vērā, ka mainoties montāžas augstumam, mainās arī minimālais augstums, un jāņem vērā arī pieslēgšanas izmēru izmaiņas.

Montāžas padoms

Lai iegrieztu savienojuma elementus, iBox ar caurules palīdzību nostipriniet skrūvspilēs.

Skalošana

Izskalojiet visu instalāciju atbilstoši DIN 1988 / EN 1717. Bultiņas uz skalošanas bloka parāda, kurš pievads ir savienots ar attiecīgo izplūdes cauruli, piem., aukstais ūdens ar 1. izplūdi un siltais ūdens ar 2. izplūdi. Ja nepieciešama tikai viena izplūde, pēc pirmās skalošanas reizes par 90° jāpagriež skalošanas bloks.

iBox kombinācijā ar Exafill vannas iebūdi ar noplūdes un pārplūdes garnitūru (skat. 95. lpp.)

Tehniskie dati

Darba spiediens:	maks. 1 MPa
Ieteicamais darba spiediens:	0,1 - 0,5 MPa
Pārbaudes spiediens:	1,6 MPa
(1 MPa = 10 bar = 147 PSI)	
Karstā ūdens temperatūra:	maks. 80 °C
Ieteicamā karstā ūdens temperatūra:	65 °C
Pieslēguma izmēri:	G ¾
Pieslēgumi:	aukstais pa labi - karstais pa kreisi
Brīva caurplūde, ja ir 0,3 MPa:	
Vannas/ dušas jaucekļkrāns:	31 l/min // 24 l/min
Vannas/ dušas jaucekļkrāns ar integrētu drošības kombināciju:	25 l/min // 24 l/min
Dušas jaucekļkrāns:	32 l/min
Termostats:	43 l/min
Termostats ar slēgvārstu.:	26 l/min
Termostats ar noslēgvārstu un pārslēdzējvārstu.:	26 l/min
Termostats High Flow:	58 l/min
iControl:	30 l/min

X	Vannas vidus / Dušas paliktņa vidus		Zemapmetuma ventilis
Y	Izmērs Y = šļūtenes savienojuma loka vidū līdz vannas ietecei vidum dalīt ar 2 (eventuāli piemērot flīžu rakstam)	 Quattro	Četrvirzienu pārslēgs
	Siltais ūdens	 Trio	Trisvirzienu universālais noslēgvārsts un pārslēdzējvārsts
	Aukstais ūdens		Vannas tekne
	No • funkcija nodrošināta		Neizmanto izteku aizbāzt ar aizbāzni. (DN 20 3/4")
	Šajā zonā ir nepieciešams pastiprināt sienu.		Noteces veiktspējai jābūt vairāk nekā 50 l/min.
	Iespējams tikai viens patērētājs, nedrīkst vienlaikus būt divi patērētāji.	> 50 l/min	Notece
	Montēt ūdens cauruļvadus sānu (ķermeņa) dušām ar atbilstošu slīpumu.		Raindrain
	Skalošanas bloks, kompl. #15956000, komplektā netiek piegādāts		Exafill iBox kombinācijā ar Exafill vannas iepļūdi ar noplūdes un pārplūdes garnitūru (skat. 95. lpp.)

DVGW

 Vannas/ dušas jaučējkraņš ar integrētu drošības kombināciju (skat. lpp. 96)

Dušas jaučējkraņš (skat. lpp. 104, 106, 110, 124)



Vannas/ dušas jaučējkraņš (skat. lpp. 98, 102, 114, 116)



Vannas tekne (skat. lpp. 102)

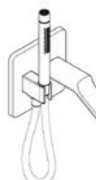



Termostats
(skat. lpp. 118, 122, 126)



High Flow Termostats
(skat. lpp. 128 - 138, 142, 144, 150 - 158)



Termostats ar slēgvārstu.
(skat. lpp. 104, 106, 110, 124)



Termostats ar noslēgvārstu un pārslēdzējvārstu.
(skat. lpp. 98, 114, 116, 120)



High Flow Termostats ar slēgvārstu.
(skat. lpp. 140, 146, 148)

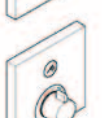

Termostats ar slēgvārstu.
(skat. lpp. 104, 106, 110)

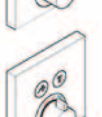

Termostats ar slēgvārstu.
(skat. lpp. 98, 114, 116, 120)

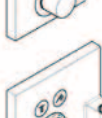

Termostats ar slēgvārstu.
(skat. lpp. 100, 112)



ShowerSelect Dušas ļaucējkrāns
(skat. lpp. 104, 106, 110)



ShowerSelect Vannas/ dušas ļaucējkrāns
(skat. lpp. 98, 114, 116, 120)



iControl
Noslēgvārstis un pārslēdzējvārstis (skat. lpp. 150)



ShowerSelect
3 x Slēgvārstis (skat. lpp. 144, 146 - 150, 158)



Raindance Showerpipe
(skat. lpp. 108)



Raindance Rainfall 240
(skat. lpp. 140, 142)



Raindance Rainfall 180
(skat. lpp. 154 - 158)



Raindance E 420
(skat. lpp. 150, 152)



Raindance Select E 300
(skat. lpp. 148)

Pripremna montaža

Rotaciono simetrično telo jedinice iBox je univerzalno primenljivo, kako horizontalno tako i vertikalno. Izuzetak predstavlja montaža armatura za kade sa sigurnosnom kombinacijom, jer je tu moguća samo vertikalna ugradnja. Pošto kod kvara pojedinih delova iz iBox-a može isticati voda, iBox se mora instalirati iznad kade, tako da voda može oticati u kadu!

iBox je pogodan za ugradnju na tuš i instalaciju za kade. Kod jednoručnih mešača za kadu / termostata s ventilom za zatvaranje i preklopnim ventilom prioritetan je donji izlaz. Kod instalacije na tuš izlaz koji se ne upotrebljava mora da se zatvori čepom.

Velika razlika u pritisku između vruće i hladne vode mora biti izbalansirana.

Montirajte telo tako da priključak tople vode bude sa leve, a hladne sa desne strane.

Dubina ugradnje 80 - 108 mm.

Produžetak 25 mm br. Proizvoda 13595000

Produžetak 22 mm (kod manje dubine ugradnje)

br. Proizvoda 13593000 / 13596XXX / 13597XXX / 15597000 / 19427000 / 97407XXX / 98860000

Telo može da se montira u skladu sa uslovima na mestu ugradnje, za primere montaže vidi strane 91 i 92.

A Direktna instalacija na zid.

B Direktna instalacija na zid s držačem odstojanja pomoću 10 mm podesivih zavrtnja.

C Montaža na sistem nosača.

D Instalacija na gotove montažne ploče ili gotove ćelije.

E Instalacija direktno u zid.

F Instalacija sa setom instalacionih žina #96615000.

Primeri instalacija sa veličinama i dimenzijama vodova mogu se naći od stranice 96 nadalje. Objašnjenje korišćenih simbola nalazi se na stranici 75 i 76.

Montažne dimenzije navedene u uputstvu za montažu idealne su za osobe visine oko 1800 mm, tako da se po potrebi moraju prilagoditi konkretnoj visini korisnika. Pri tome treba uzeti u obzir da se prilikom promene montažne visine menja i minimalna visina kao i da se u tom slučaju mora uvažiti i promena priključnih dimenzija.

Savet u vezi montaže

Za uvrtnje priključnih elemenata iBox treba zategnuti u stegu uz pomoć komada cevi.

Ispiranje

Kompletnu instalaciju treba isprati u skladu sa normom DIN 1988 / EN 1717. Strelice na bloku prikazuju koji je dovod spojen sa kojim odvodom, npr. hladna voda sa odvodom 1, a topla voda sa odvodom 2. Ukoliko je potreban samo jedan odvod, onda se nakon prvog ispiranja blok mora zakrenuti za 90°.

iBox u kombinaciji sa Exafill dotokom kade sa odvodnom i prelivnom garniturom (vidi stranu 95)

Tehnički podaci

Radni pritisak:	maks. 1 MPa
Preporučeni radni pritisak:	0,1 - 0,5 MPa
Probni pritisak:	1,6 MPa
(1 MPa = 10 bar = 147 PSI)	
Temperatura vruće vode:	maks. 80°C
Preporučena temperatura vruće vode:	65°C
Rastojanje između centara priključaka:	G ¾
Priključci:	hladna voda desno - topla levo
Slobodan protok na 0,3 MPa:	
Mešač za kadu:	31 l/min // 24 l/min
Mešač za kadu s ugrađenim sigurnosnim sistemom:	
	25 l/min // 24 l/min
Mešač tuša:	32 l/min
Termostat:	43 l/min
Termostat s ventilom za zatvaranje:	26 l/min
Termostat s ventilom za zatvaranje i preklopnim ventilom:	
26 l/min	
Termostat High Flow:	58 l/min
iControl:	30 l/min

X

Sredina kade / Sredina tuš-kada



Uzidni ventil

Y

Mera Y = sredina priključnog luka creva do sredine dotoka kade podeljeno sa 2 (eventualno prilagoditi rasteru pločica).



Quattro

Quattro četvorostruki preusmerivač



Topla voda

Hladna voda



Trio

Trio Universal ventil za zatvaranje i preklopni ventil



Od • je funkcija zagarantovana.



Dotok kade



U ovoj oblasti je potrebno ojačanje zida.



Izlaz koji se ne koristi, mora se zatvoriti slepim čepom. (DN 20 ¾")



Moguće je koristiti samo jedan potrošač, nikako dva istovremeno!



> 50 l/min

Kapacitet odvoda mora biti veći od 50 l/min.



Položite vodovodne cevi za bočni tuš s nagibom.



Raindrain

Ispust



kompletan blok #15956000, Nije sadržano u isporuci



Exafill

iBox u kombinaciji sa Exafill dotokom kade sa odvodnom i prelivnom garniturom (vidi stranu 95)

DVGW



Mešač za kadu s ugrađenim sigurnosnim sistemom (vidi stranu 96)



Mešač tuša (vidi stranu 104, 106, 110, 124)



Mešač za kadu (vidi stranu 98, 102, 114, 116)

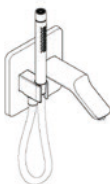

Dotok kade (vidi stranu 102)



Termostat
(vidi stranu 118, 122, 126)



High Flow Termostat
(vidi stranu 128 - 138, 142, 144, 150 - 158)



Termostat s ventilom za zatvaranje
(vidi stranu 104, 106, 110, 124)

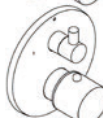

Termostat s ventilom za zatvaranje i
preklopnim ventilom
(vidi stranu 98, 114, 116, 120)



High Flow Termostat s ventilom za
zatvaranje
(vidi stranu 140, 146, 148)

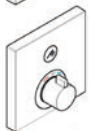

Termostat s ventilom za zatvaranje
(vidi stranu 104, 106, 110)



Termostat s ventilom za zatvaranje
(vidi stranu 98, 114, 116, 120)



Termostat s ventilom za zatvaranje
(vidi stranu 100, 112)



ShowerSelect Mešač tuša
(vidi stranu 104, 106, 110)



ShowerSelect Mešač za kadu
(vidi stranu 98, 114, 116, 120)



iControl
Ventil za zatvaranje i preklopnii ventil
(vidi stranu 150)

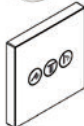

ShowerSelect
3 x Ventil za zatvaranje (vidi stranu
144, 146 - 150, 158)



Raindance Showerpipe
(vidi stranu 108)



Raindance Rainfall 240
(vidi stranu 140, 142)

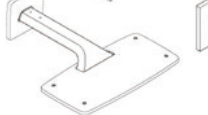

Raindance Rainfall 180
(vidi stranu 154 - 158)

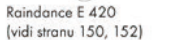

Raindance E 420
(vidi stranu 150, 152)

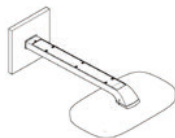

Raindance Select E 300
(vidi stranu 148)

Råmontasje

Det rotasjonsymetriske baseelementet til iBox kan brukes universelt dvs. horisontalt og vertikalt. Et unntak er ved montasje av kararmatur med sikkerhetskombinasjon. Da er det kun mulig med vertikal montasje. Ettersom det kan lekke vann ut av iBoxen ved en defekt, skal iBoxen monteres over badekaret, slik at vannet som lekker ut kan renne ned i badekaret.

iBoxen egner seg både for installasjon på dusj eller badekar. Ved enhånd-blandebatteri for badekar / termostat med sperre- og omstillingsventil prioriteres nedre utgangen. Ved installasjon i dusjen skal utgangen som ikke brukes tettes med en plugg.

Store trykkdifferanser mellom kaldt- og varmtvannstilkoblinger skal utlignes.

Baseelementet bygges inn slik at varmtvannstilkobling er på venstre og kaldtvannstilkobling er på høyre side.

Innbyggingsdybde 80 mm til 108 mm.

Forlengelse 25 mm Artikelnummer 13595000

Forlengelse 22 mm (ved liten montasje dybde)

Artikelnummer 13593000 / 13596XXX / 13597XXX / 15597000 / 19427000 / 97407XXX / 98860000

Baseelementet kan monteres iht. byggmessige forhold, se montasje-eksempel på side 91 og 92.

A Installasjon på vegg

B Installasjon på vegg. Her med fleksible avstandsholdere via spesialskruer.

C Montasje på bæresystem.

D Installasjon på ferdighus-montasjeplater eller prefabrikkert celler.

E Installasjon rett på vegg.

F Installasjon med sett av montasjeskinner #96615000.

Installasjonseksempel med målangivelser og ledningsdimensjoner finns fom. side 96. Forklaring for brukte symboler på side 78 og 79.

Monteringsmål i monteringsveiledningen er beregnet for personer som er omtrent 1800 mm høye, målene skal eventuell tilpasses om nødvendig. Her skal man passe på at ved endrede monteringsmålene blir minstehøyden endret, og det må tas hensyn til de endrede tilkoblingsmålene.

Montasje-tipp

For å skru inn koblinger skal iBoxen settes fast i en skruttikke ved hjelp av et rær.

Spyle

Komplett installasjon spyles iht. DIN 1988 / EN 1717. Pilene på spyleblokken indikerer hvilke tilløp som er koblet sammen med hvilken utgangsledning, f.eks. kaldtvann med utgang 1 og varmtvann med utgang 2. Hvis det kun er nødvendig med en utgang, skal spyleblokken dreies med 90° etter den første spylingen.

iBox i kombinasjon med Exfill karinnløp med avløps- og overflytgarnityr (se side 95)

Tekniske data

Driftstrykk	maks. 1 MPa
Anbefalt driftstrykk:	0,1 - 0,5 MPa
Prøvetrykk	1,6 MPa
(1 MPa = 10 bar = 147 PSI)	
Varmtvannstemperatur	maks. 80°C
Anbefalt temperatur for varmt vann	65°C
Tilkoblingsmål:	G ¾
Tilkoblinger:	kaldt høyre - varm venstre
Fri gjennomstrømning ved 0,3 MPa:	
Blandebatteri for badekar:	31 l/min // 24 l/min
Blandebatteri for badekar med integrert sikkerhetskombinasjon:	25 l/min // 24 l/min
Dusj-blandebatteri:	32 l/min
Termostat:	43 l/min
Termostat med sperreventil:	26 l/min
Termostat med sperre- og omstillingsventil:	26 l/min
Termostat High Flow:	58 l/min
iControl:	30 l/min

X

Midten av badekaret / Midten på dusjkar



Innfelt ventil

Y

Mål Y = Midten til slangetilkoblingsbue t.o.m. badekarinnløp delt på 2 (eventuelt skal fliseraster tilpasses).



Quattro fire-veis omstilling

Quattro



Varmtvann



Trio universal stenge- og omstillingsventil

Kaldtvann

Trio



F.o.m. • er funksjonen garantert



Innløp badekar



I dette området skal veggen forsterkes.



Utgangen som ikke brukes kan tettes med en blindplugg. (DN 20 3/4")



Kun en forbruker mulig, ikke to samtidig.



Avløp ytelse skal være mer enn 50 l/min.

> 50 l/min



Vannledninger for sidedusjer installeres med fall.



Avløp

Raindrain



Spyleblokk kpl. #15956000, ikke med i leveransen



Exafill

iBox i kombinasjon med Exafill karinnløp med avløps- og overflytgarntyr (se side 95)

DVGW



Blandebatteri for badekar med integrert sikkerhetskombinasjon (se side 96)



Dusj-blandebatteri (se side 104, 106, 110, 124)



Blandebatteri for badekar (se side 98, 102, 114, 116)

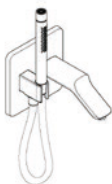

Innløp badekar (se side 102)



Termostat
(se side 118, 122, 126)



High Flow

High Flow Termostat
(se side 128 - 138, 142, 144, 150 - 158)



Termostat med sperreventil
(se side 104, 106, 110, 124)



Termostat med sperre- og omstillingsventil
(se side 98, 114, 116, 120)



High Flow

High Flow Termostat med sperreventil
(se side 140, 146, 148)

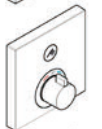

Termostat med sperreventil
(se side 104, 106, 110)



Termostat med sperreventil
(se side 98, 114, 116, 120)



Termostat med sperreventil
(se side 100, 112)



ShowerSelect Dusch-blandebatteri
(se side 104, 106, 110)



ShowerSelect Blandebatteri for badekar
(se side 98, 114, 116, 120)



iControl Stenge- og omstillingsventil (se side 150)

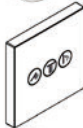

ShowerSelect 3 x Sperreventil (se side 144, 146 - 150, 158)



Raindance Showerpipe
(se side 108)



Raindance Rainfall 240
(se side 140, 142)

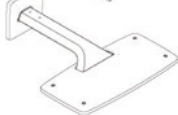

Raindance Rainfall 180
(se side 154 - 158)

Raindance E 420
(se side 150, 152)

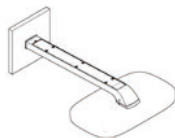

Raindance Select E 300
(se side 148)

Първичен монтаж

Ротационно-симетричното основно тяло на iBox може да се приложи универсално, хоризонтално и вертикално. Изключение прави монтажът на арматурата за вана с комплект предпазители, тук е възможен само вертикален монтаж. Тъй като при дефект на функционалните части около iBox може да изтече вода, iBox трябва да се монтира над ваната, за да може изтичащата вода да се отича във ваната!

iBox е подходяща както за инсталации на вани, така и за души. При смесители за вана с една ръкохватка / термостат със спирателен и превключващ клапан първостепенен е долният извод. При инсталация на разпръсквател излишният извод трябва да се уплътни с глуха пробка.

Големите разлики в налягането между изводите за студената и топлата вода трябва да се изравняват.

Основното тяло се монтира така, че изводът за топла вода да се намира отляво, а за студена вода отдясно.

Монтажна дълбочина 80 мм до 108 мм.

Удължител 25 мм Номенклатурен номер 13595000

Удължител 22 мм (при малка монтажна дълбочина)

Номенклатурен номер 13593000 / 13596XXX / 13597XXX / 15597000 / 19427000 / 97407XXX / 98860000

Основното тяло може да се закрепи на стената в съответствие с конструктивните дадености, примери за монтаж на стр. 91 и 92.

A Инсталация на стената.

B Инсталация на стената. Тук с гъвкава разпънка с помощта на комбинирани болтове 10.

C Монтаж на трегерната система.

D Инсталация върху монтажни плочи на стобяеми сгради или готови клетки.

E Инсталация директно в стената.

F Инсталация с набор монтажни шини #96615000.

Примери за инсталация с данни за размери и определяне на размерите на тръбопроводите можете да намерите от стр. 96 нататък. Разяснения на използваните символи на стр. 81 и 82.

Посочените в ръководството за монтаж монтажни мерки са идеални за лица с ръст от прикл. 1800 мм и трябва съответно да се пригодят. При това обърнете внимание на това, при променена монтажна височина се променя минималната височина и трябва да бъде взета под внимание промяната на присъединителните размери.

Съвети при монтаж

За да завинтите присъединителните елементи затегнете iBox с помощта на тръбен елемент в менюме.

Промиване

Промийте цялата инсталация съгласно DIN 1988 / EN 1717. Стрелките на промиващия блок показват, кой вход с кой изходящ тръбопровод е свързан, напр. студена вода с извод 1, а топла вода с извод 2. В случай, че е необходим само един изход, след първия процес на промиване промиващият блок трябва да се завърти на 90°.

**iBox в комбинация с вход за вана
Ehafill с гарнитура за изтичане и
преливане.** (вижте стр. 95)

Технически данни

Работно налягане:	макс. 1 МПа
Препоръчително работно налягане:	0,1 - 0,5 МПа
Контролно налягане:	1,6 МПа
[1 МПа = 10 bar = 147 PSI]	
Температура на горещата вода:	макс. 80°C
Препоръчителна температура на горещата вода:	65°C
Присъединителни размери:	G ¾
Изводи:	студено отдясно – топло отляво
Свободен поток при 0,3 МПа:	
Смесител за вана:	31 л/мин // 24 л/мин
Смесител на вана с интегриран комплект предпазители:	25 л/мин // 24 л/мин
Смесител на разпръсквателя:	32 л/мин
Термостат:	43 л/мин
Термостат със спирателен клапан:	26 л/мин
Термостат със спирателен и превключващ клапан:	26 л/мин
Термостат High Flow:	58 л/мин
iControl:	30 л/мин

X	Среда на ваната / Среда на коритото на душ-кабината		Клапан за мазилка
Y	Марка Y = Среда на присъединителното коляно на маркуча до входа на ваната разделено на 2 (евентуално изравнете към растера на плочките).	 Quattro	Четирипътно превключване Quattro
	Топла вода	 Trio	Спирателен и превключващ клапан Trio Universal
	Студена вода		Вход за ваната
	От • функцията е гарантирана.		Излишният извод може да се уплътни с глуха пробка. (DN 20 3/4")
	В тази област е необходимо подсилване на стената.		Мощността на изтичане трябва да бъде повече от 50 л/мин.
	Възможен е само един консуматор, не два едновременно.		Отвеждане
	Водопроводните линии за страничните разпръскватели полагайте с наклон.		iVox в комбинация с вход за ваната Exafill с гарнитура за изтичане и преливане. (вижте стр. 95)
	Изплакващ блок компл. #15956000, не се съдържа в обема на доставка		

DVGW  Смесител на ваната с интегриран комплект предпазители (вижте стр. 96)

 Смесител на разпръсквателя (вижте стр. 104, 106, 110, 124)

 Смесител за ваната (вижте стр. 98, 102, 114, 116)

 Вход за ваната (вижте стр. 102)



Термостат
(вижте стр. 118, 122, 126)



High Flow

High Flow Термостат
(вижте стр. 128 - 138, 142, 144, 150 - 158)



Термостат със спирателен клапан
(вижте стр. 104, 106, 110, 124)



Термостат със спирателен и превключващ клапан
(вижте стр. 98, 114, 116, 120)



High Flow

High Flow Термостат със спирателен клапан
(вижте стр. 140, 146, 148)

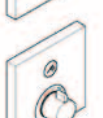

Термостат със спирателен клапан
(вижте стр. 104, 106, 110)

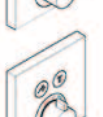

Термостат със спирателен клапан
(вижте стр. 98, 114, 116, 120)

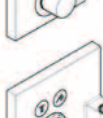

Термостат със спирателен клапан
(вижте стр. 100, 112)



ShowerSelect Смесител на разпръсквателя
(вижте стр. 104, 106, 110)



ShowerSelect Смесител за ванна
(вижте стр. 98, 114, 116, 120)



iControl
Спирателен и превключващ клапан
(вижте стр. 150)



ShowerSelect
3 x Спирателен клапан (вижте стр. 144, 146 - 150, 158)



Raindance Showerpipe
(вижте стр. 108)



Raindance Rainfall 240
(вижте стр. 140, 142)



Raindance Rainfall 180
(вижте стр. 154 - 158)



Raindance E 420
(вижте стр. 150, 152)



Raindance Select E 300
(вижте стр. 148)

Montimi në vija të trasha

Trupi bazë me rotacion simetrik i iBox-it mund të përdoret në mënyrë universale, si horizontalisht, ashtu edhe vertikalisht. Me përjashtim të montimit të armaturës së vaskës me kombinim me elemente sigurie. Kështu është i mundur vetëm montimi vertikal. Meqë në rast të ndonjë defekti të pjesëve funksionale mund të rrjedhë ujë nga iBox-i, është e nevojshme që iBox-i të montohet sipër vaskës, me qëllim që uji që rrjedh të derdhet në vaskë! iBox-i është i përshtatshëm si për instalimin me vaskë, ashtu edhe me dushin. Te rubinetet me një dorezë për përzjerjen e ujit për vaskën / termostati me ventil bllokues dhe ventil për ndërrimin e pozicionit ka prioritet dalja e poshtme. Në rast se instalohet dushi, atëherë dalja që nuk nevojitet duhet mbyllur me një tapë.

Ndryshimet e mëdha të presionit mes lidhjeve të ujit të ftohtë dhe atij të ngrohtë duhen ekuilibruar.

Trupi bazë duhet montuar në atë mënyrë që lidhja e ujit të ngrohtë të jetë në të majtë dhe ajo e ujit të ftohtë në të djathtë.

Thellësia e montimit 80 mm deri 108 mm.

Zgjatësi 25 mm Numri i artikullit 13595000

Zgjatësi 22 mm (Iartësia e montimit jo e madhe)

Numri i artikullit 13593000 / 13596XXX / 13597XXX / 15597000 / 19427000 / 97407XXX / 98860000

Trupi bazë mund të montohet duke iu përshtatur kushteve ndërtimore. Shembuj të montimit gjinden në faqet 91 dhe 92.

A Instalimi në mur.

B Instalimi në mur. Këtu me distancues të lakueshëm përmes vidhave lidhëse 10-she.

C Montimi në sistemin mbajtës.

D Instalimi në pllakat e montimit të shtëpive parafabrikate ose në qelizat e gotshme.

E Instalimi direkt në mur.

F Instalimi me kompletin e shinave të montazhit #96615000.

Shembujt e instalimit me përmasat dhe dimensionimet e tubacioneve mund t'i gjeni nga faqja 96. Shpjegimi i simboleve të përdorura gjendet në faqen 84 dhe 85.

Përmasat e montimit të cekura në udhëzimin teknik të montimit janë ideale për persona me gjatësi afro 1800 mm (180 cm) dhe eventualisht duhen përshtatur. Këtu duhet pasur parasysh që me ndryshimin e lartësisë së montimit, ndryshon edhe lartësia e cekur minimale si dhe ndryshimi i përmasave të lidhjeve.

Këshilla rreth montimit

Për të rrotulluar lidhjet duhet lidhur iBox/ me anë të një pjese të tubit në morskë.

Shpëlarje

I gjithë instalimi duhet shpërlarë në bazë të normës DIN 1988 / EN 1717. Shigjetat në bllokun shpërlarës tregojnë se cila hyrje është lidhur me cilën dalje, p.sh. uji i ftohtë me daljen 1 dhe uji i ngrohtë me daljen 2. Nëse nevojitet vetëm një dalje, atëherë pas shpërlarjes së parë blloku shpërlarës duhet rrotulluar 90°.

iBox-i në kombinim me në garniturë dalëse dhe rrjedhëse Exafill hyrjen e vaskës (shih faqen 95)

Të dhëna teknike

Presioni gjatë punës	maks. 1 MPa
Presioni i rekomanduar:	0,1 - 0,5 MPa
Presioni për provë:	1,6 MPa
(1 MPa = 10 bar = 147 PSI)	
Temperatura e ujit të ngrohtë	maks. 80°C
Temperatura e rekomanduar e ujit të ngrohtë:	65°C
Përmasat e lidhjeve:	G ¾
Lidhjet:	i ftohtë djathtas - i ngrohtë majtas
Rrjedhja e lirë me 0,3 Mpa:	
Rubineti i vaskës:	31 l/min // 24 l/min
Rubineti i vaskës me kombinim të integruar të siguriës:	
	25 l/min // 24 l/min
Spërkatësja me ujë të përzjer:	32 l/min
Termostati:	43 l/min
Termostati me ventil bllokues:	26 l/min
Termostati me ventil bllokues dhe ventil për ndërrimin e pozicionit:	26 l/min
Termostati High Flow:	58 l/min
iControl:	30 l/min

Shqip

X

Mesi i vaskës / Mesi i vaskës së dushit



Ventili i suvajës

Y

Përmasa Y = mesi i harkut të lidhjes së zorrës deri tek mesi i hyrjes së vaskës pjesëtim për 2 (eventualisht i duhet përshtatur këndit të pllakave të murit).



Valvul devijuese Quattro me katër drejtime

Quattro



Uji i ngrohtë



Valvul universale Trio për bllokim dhe devijim

Trio

Uji i ftohtë



Nga • është i mundur funksioni.



Vrima për mbushjen e vaskës



Në këtë zonë është i nevojshëm një përforsim i murit.



Dalja që nuk nevojitet duhet izoluar me tapë qorre. (DN 20 3/4")



Ekziston mundësia vetëm për një konsumator, jo për dy njëkohësisht.



Kapaciteti i shkarkimit duhet të jetë më shumë se 50 l/minutë.

> 50 l/min



Vendosni tubacionet e ujit për spërkatëset anësore me pjerrësi.



Shkarkimi

Raindrain



Bloku shpëlarës komplet #15956000, nuk përfshihet në vëllimin e furnizimit



iBox-i në kombinim me në garniturë dalëse dhe rrjedhëse Exafill hyrjen e vaskës (shih faqen 95)

Exafill

DVGW



Rubineti i vaskës me kombinim të integruar të sigurisë (shih faqen 96)



Spërkatësja me ujë të përzier (shih faqen 104, 106, 110, 124)



Rubineti i vaskës (shih faqen 98, 102, 114, 116)

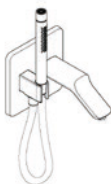

Vrima për mbushjen e vaskës (shih faqen 102)



Termostati
(shih faqen 118, 122, 126)



High Flow

High Flow Termostati
(shih faqen 128 - 138, 142, 144, 150 - 158)



Termostat me ventil bllokues
(shih faqen 104, 106, 110, 124)



Termostati me ventil bllokues dhe ventil për ndërrim e pozicionit
(shih faqen 98, 114, 116, 120)



High Flow

High Flow Termostat me ventil bllokues
(shih faqen 140, 146, 148)

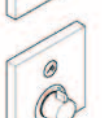

Termostat me ventil bllokues
(shih faqen 104, 106, 110)

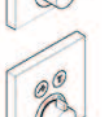

Termostat me ventil bllokues
(shih faqen 98, 114, 116, 120)

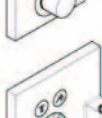

Termostat me ventil bllokues
(shih faqen 100, 112)



ShowerSelect Spërkatësja me ujë të përzier
(shih faqen 104, 106, 110)



ShowerSelect Rubineti i vaskës
(shih faqen 98, 114, 116, 120)



iControl
Valvula e bllokimit dhe e devijimit (shih faqen 150)



ShowerSelect
3 x Ventil bllokues (shih faqen 144, 146 - 150, 158)



Raindance Showerpipe
(shih faqen 108)



Raindance Rainfall 240
(shih faqen 140, 142)



Raindance Rainfall 180
(shih faqen 154 - 158)

Raindance E 420
(shih faqen 150, 152)

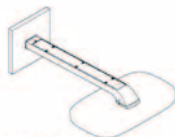

Raindance Select E 300
(shih faqen 148)



ثرموستات
(راجع صفحة 126, 122, 118)



High Flow
ثرموستات High Flow
(راجع صفحة 142, 138 - 128)
(158 - 150, 144)



ثرموستات متصل بصمام غلق
(راجع صفحة 124, 110, 106, 104)



ثرموستات متصل بصمامات غلق
وإخويل
(راجع صفحة 120, 116, 114, 98)

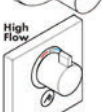

High Flow
ثرموستات High Flow
غلق متصل بصمام
(راجع صفحة 148, 146, 140)

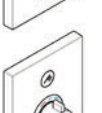

ثرموستات متصل بصمام غلق
(راجع صفحة 110, 106, 104)

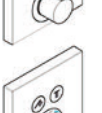

ثرموستات متصل بصمام غلق
(راجع صفحة 120, 116, 114, 98)

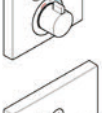

ثرموستات متصل بصمام غلق
(راجع صفحة 112, 100)



ShowerSelect خلاط الدش
(راجع صفحة 110, 106, 104)



ShowerSelect خلاط دش الحمام
(راجع صفحة 120, 116, 114, 98)



iControl
صمام الحجز والتغيير (راجع صفحة 150)

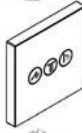

ShowerSelect
صمام إيقاف 3 x
(راجع صفحة 144, 158, 150 - 146)



Raindance Showerpipe
(راجع صفحة 108)



Raindance Rainfall 240
(راجع صفحة 142, 140)



Raindance E 420
(راجع صفحة 152, 150)





Raindance Rainfall
180
(راجع صفحة 154 - 158)



Raindance Select E 300
(راجع صفحة 148)

X	منتصف حوض الاستحمام / بانيو مزود بدش في المنتصف		صمام التدفق
Y	البعد $Y =$ مركز مرفق منحرج حائط الخرطوم إلى مركز حشوة الحمام مقسوماً على 2 (مطابق لشكل البلاطة إن أمكن).	 Quattro	تغيير مسار رباعي كواترو
	ماء دافئ ماء بارد	 Trio	صمام حجز وتغيير تريبو يونيفرسال
	من * الوظيفة مضمونة.		مدخل مياه للبانيو
	يلزم هذا في النطاق وجود تقوية للحائط.		قم بسد المنفذ غير المستخدم. (DN 20) ("3/4")
	لا يمكن القيام بأكثر من وظيفة واحدة.	 !> 50 l/min	يجب أن تكون قدرة الصرف أكبر من 50 لتر/دقيقة
	قم بتركيب مواسير المياه للدش العادي المنحدر.	 Raindrain	تصريف
	قارنة وحدة الغسل 15956000 #، غير مدرج مع المحتويات المسلمة	 Exafill	وحدة "iBox" مع وحدة التدفق بالحوض من النوع "Exafill" مع لوازم تصريف الماء وتصريف تدفق المياه. (راجع صفحة 95)

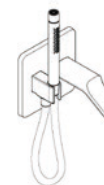
DVGW 	خلاط دش الحمام بمجموعة أمان مدمجة (راجع صفحة 96)		خلاط الدش (راجع صفحة 104, 106, 110, 124)
	خلاط دش الحمام (راجع صفحة 98, 102, 114, 116)		مدخل مياه للبانيو (راجع صفحة 102)

تركيب الأنابيب

تعد أبعاد التركيب الواردة في إرشادات التركيب هذه مثالية بالتناسبة للأشخاص الذين يبلغ طولهم حوالي 1800 م. ويمكن تغيير الأبعاد عند الحاجة. وبالتالي سينتغير الحد الأدنى للارتفاع في حالة تغيير ارتفاع التركيب. بما يعني الأخذ في الاعتبار تغيير أبعاد التوصليل.

نصائح خاصة بعملية التركيب

من أجل لف الوصلات، يجب تركيب وحدة "iBox" في الملزمة باستخدام أنبوبة.

نظام سريان الماء عبر المواسير

يجب غسل الوحدة المركبة بالكامل وفقاً للمعيار DIN 1717/EN 1988. خذ الأسهم الموجودة على وحدة الغسل أي فرع يرتبط بأية وصلة منفذ. على سبيل المثال: المياه الباردة مع المنفذ رقم 1. والمياه الساخنة مع المنفذ رقم 2. إذا كان هناك حاجة إلى منفذ واحد فقط، يجب لف وحدة الغسل قبل أول استخدام لها بنسبة 90 درجة.

وحدة "iBox" مع وحدة التدفق بالحوض من النوع "Exafill" مع لوازم تصريف الماء وتصريف تدفق المياه. (راجع صفحة 95)

المواصفات الفنية

ضغط التشغيل: الحد الأقصى 1 ميجاباسكال
 ضغط التشغيل الموصى به: 0,1 - 0,5 ميجاباسكال
 ضغط الاختبار: 1,6 ميجاباسكال
 (1 ميجاباسكال = 10 بار = 147 PSI)
 درجة حرارة الماء الساخن: الحد الأقصى 80°C
 درجة الحرارة الموصى بها للماء الساخن: 65°C
 المسافة المركزية: 3/4 G
 الوصلات: الماء البارد جهة اليمين - الماء الساخن جهة اليسار
 معدل تدفق 0,3 ميجاباسكال:
 خلاط دش الحمام: 31 لتر / الدقيقة // 24 لتر / الدقيقة
 خلاط دش الحمام بمجموعة أمان مدمجة:
 25 لتر / الدقيقة // 24 لتر / الدقيقة
 خلاط الدش:
 32 لتر / الدقيقة
 ثرموستات:
 43 لتر / الدقيقة
 ثرموستات متصل بصمام غلق:
 26 لتر / الدقيقة
 ثرموستات متصل بصمامات غلق وخوويل:
 26 لتر / الدقيقة
 ثرموستات High Flow:
 58 لتر / الدقيقة
 Control:
 30 لتر / الدقيقة

يتم استخدام الجسم الرئيسي ذيالدوران المتماثل للوحدة "iBox" في جميع أنحاء العالم سواء بصورة أفقية أو رأسية. إلا أنه لا يمكن القيام بالتركيب إلا بصورة رأسية في هذه الحالة إلا في حالة تركيب لوازم الحوض باستخدام التركيبة الأمان. أحرص دوماً على تركيب iBox فوق حوض الاستحمام (البانيو). إذا تعرضت أجزاء من iBox للكسر، فربما يتسبب ذلك في تسرب المياه في كل مكان!

تعد وحدة "iBox" ملائمة لتركيب حوض الاستحمام أو الدش. وفي حالة استخدام خلاط بالحوض بصنوبر واحد فقط / ثرموستات متصل بصمام غلق وخوويل. يفضل استخدام الصرف السفلي. وعند القيام بتركيب الدش، يجب سد المنفذ غير المستخدم عن طريق سدادة.

يجب أن يكون تيار الماء الساخن والماء البارد متعادلين في الضغط.

قم بتركيب الجسم الرئيسي للوحدة بصورة ملائمة بحيث توجد وصلة المياه الساخنة في الجانب الأيسر ووصلة المياه الباردة في الجانب الأيمن.

عمق التركيب: من 80 م حتى 108 م.

وصلة إطالة 25 م رقم الصنف 13595000

طقم للملحقات 22 م (عندما لا يكون الجدار عميقاً بما يكفي).

رقم الصنف 13596XXX / 13597XXX // 13593000
 15597000 / 19427000 / 97407XXX / 98860000

يتم تركيب الجسم الرئيسي للوحدة وفقاً لظروف البناء. انظر أمثلة التركيب صفحتي 91 و 92.

A التركيب على حائط مباشر

B التركيب على الحائط المباشر بجوابط تركيب قابلة للضبط طولها 10 م.

C التركيب على نظام حملات.

D التركيب على حائط مجوف

E التركيب على حائط من الطوب

F التركيب باستخدام طقم التثبيت #96615000.

يوجد بدءاً من صفحة 96 أمثلة للتركيب بمقاسات وطرق عمل بعض الوصلات. يوجد شرح للرموز المستخدمة على الصفحات 86 و 87.

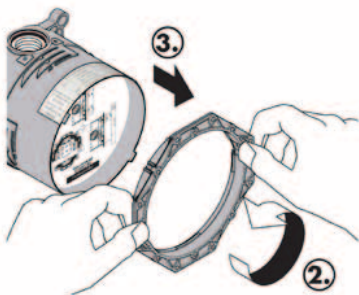
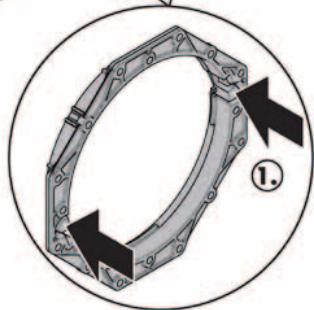
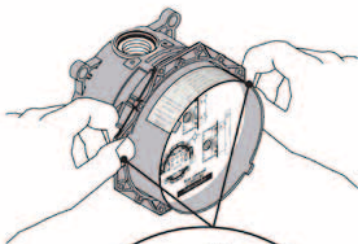
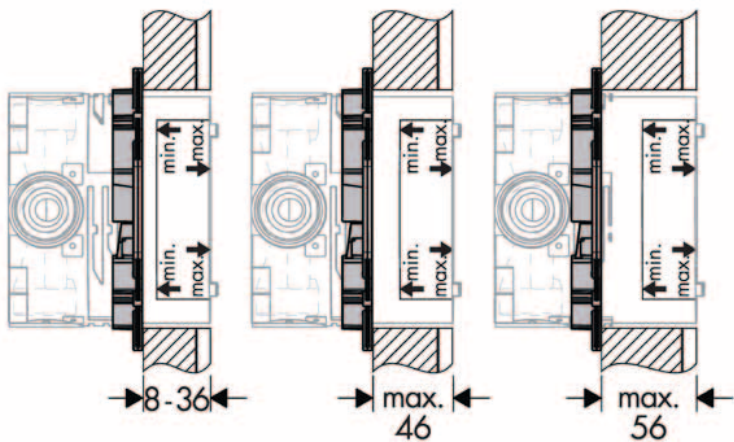

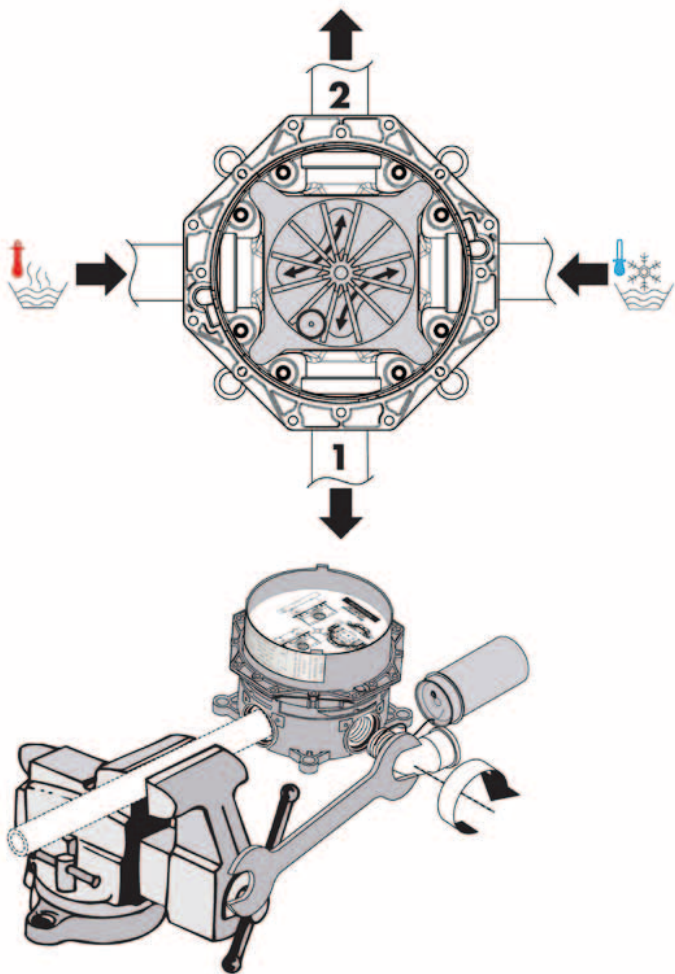

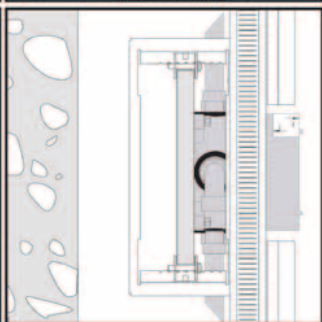
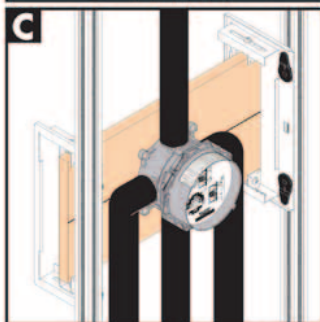
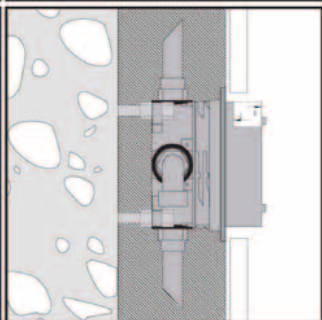
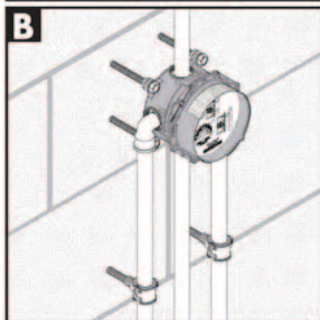
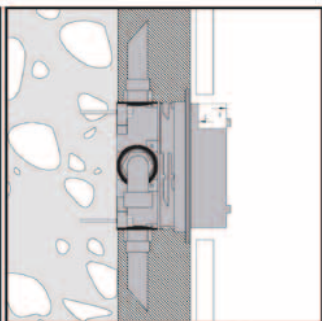
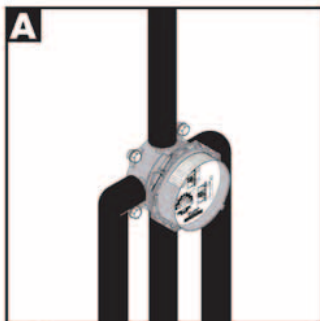

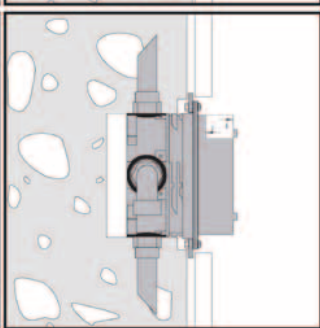
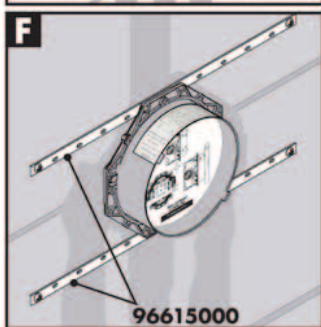
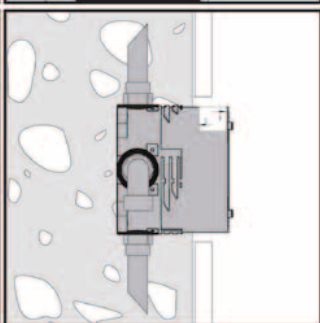
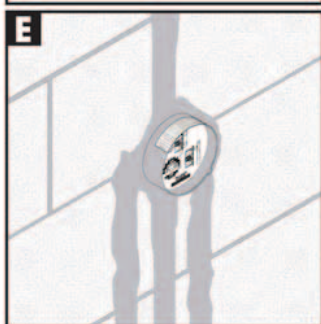
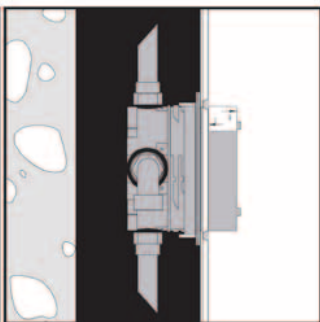
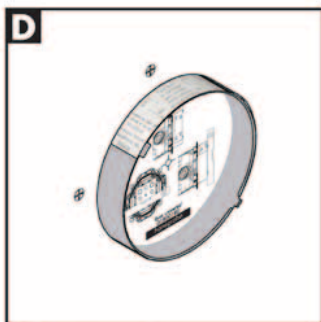

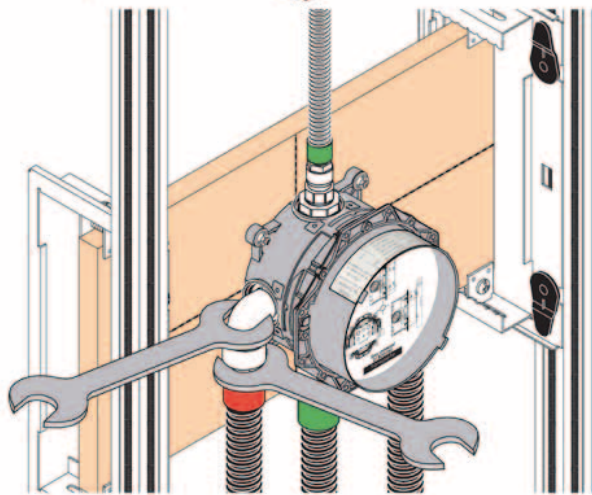
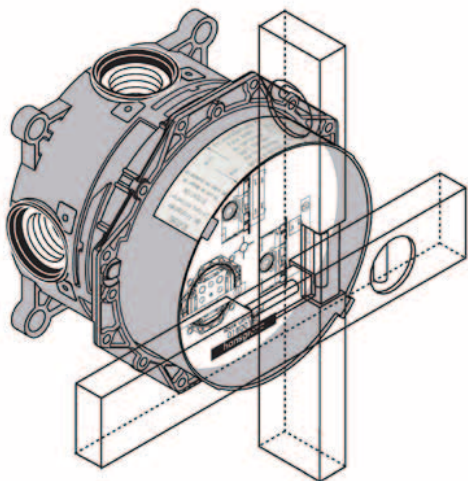

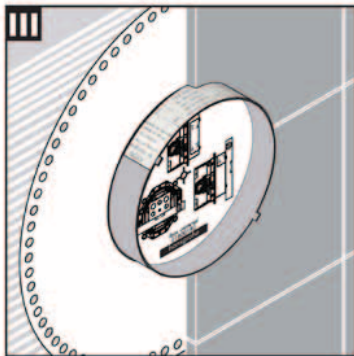
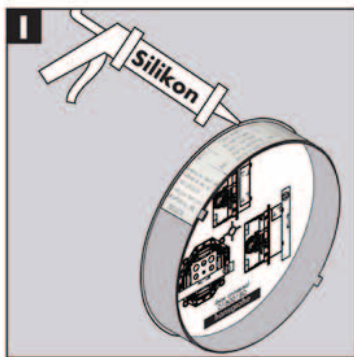

Prüfzeichen / Classification acoustique et débit / Test certificate / Segno di verifica / Marca de verificaci3n / Keurmerk / Godkendelse / Marca de controlo / Znak jakořci / Zkušební značka / Osvedčenie o skúške / 检验标
 记 / Знак технического контроля / Vizsgajel / Koestusmerkki / Testsigill / Bandyto pažyma / Oznaka testiranja /
 Kontrol isareti / Certificat de testare / Σήμα ελέγχου / Preskusni znak / Kontrollsertifikaat / Pārbaudes zīme / Ispitni
 znak / Prøvemerke / Контролен знак / Shenja e kontrollit / شهادة اختبار

P-IX	DVGW	SVGW	WRAS	KIWA	ACS
PA-IX 18989/ID	BP5615	X	X	X	X



iBox universal + Exafill

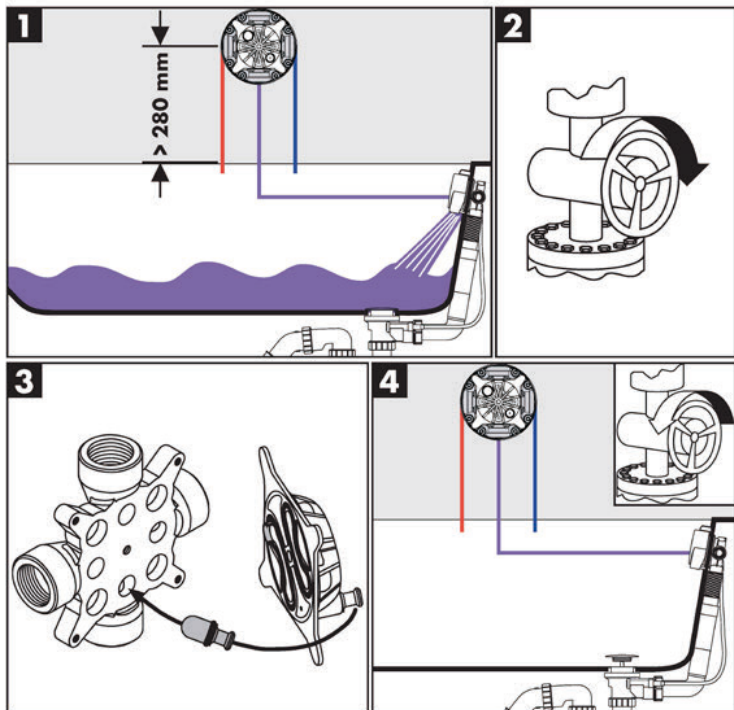
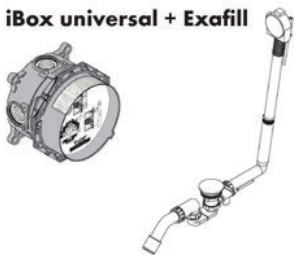

DVGW

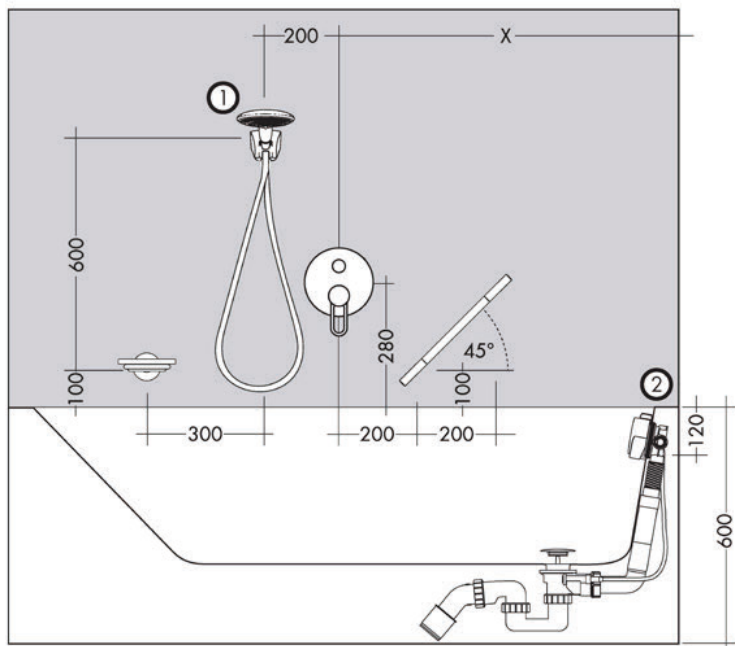
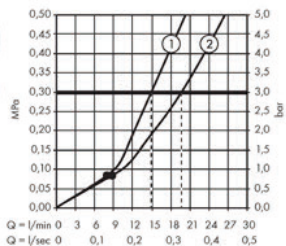

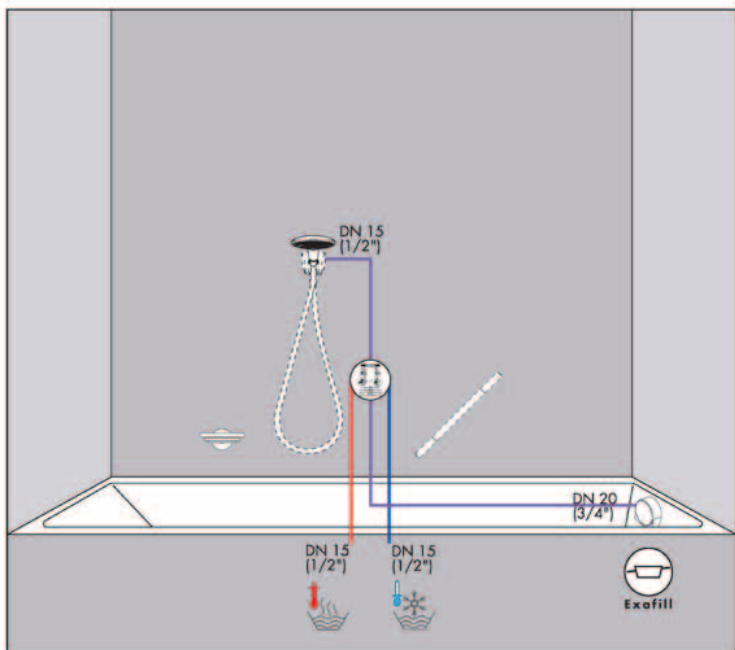

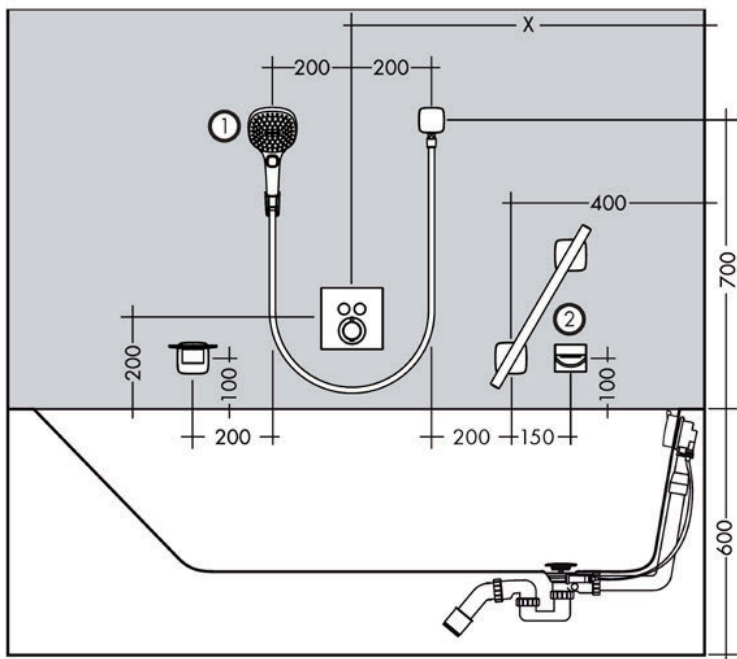
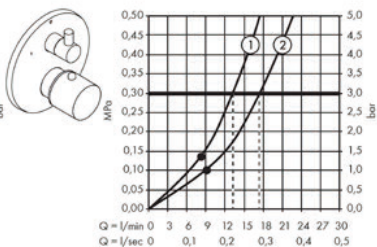
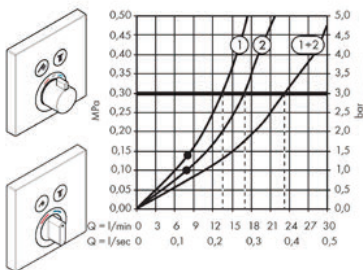

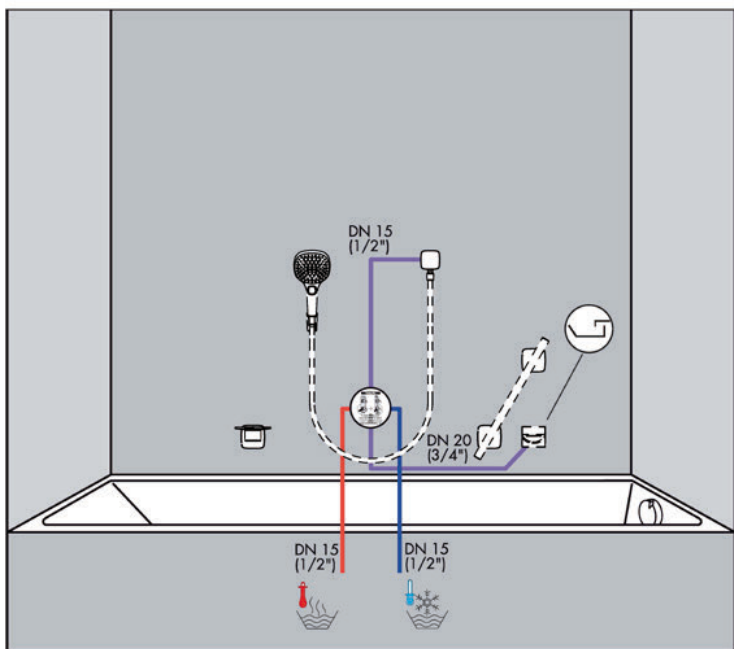
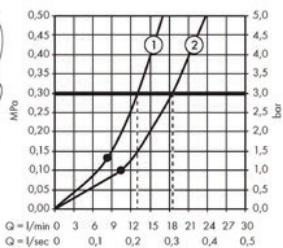

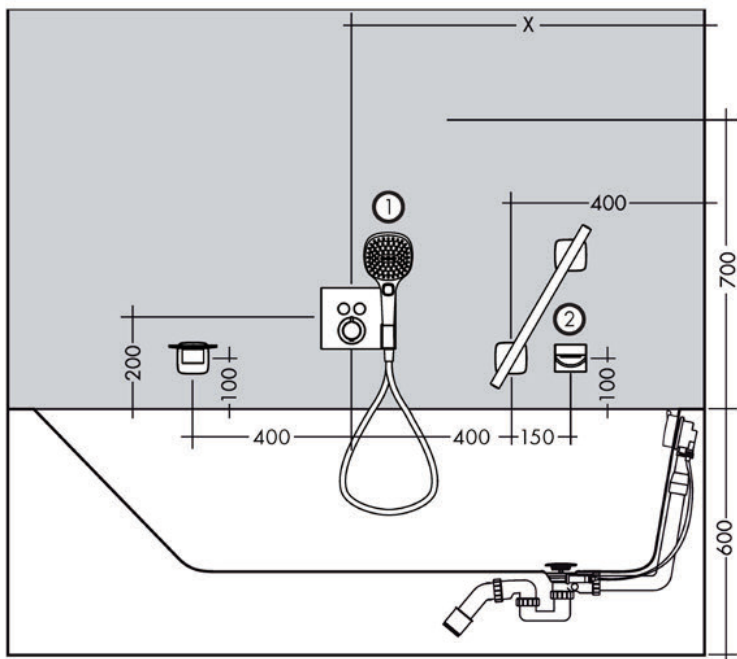
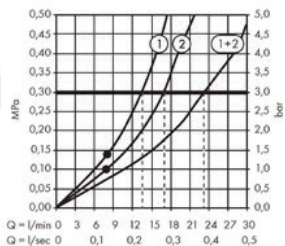
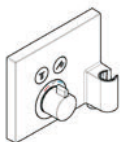

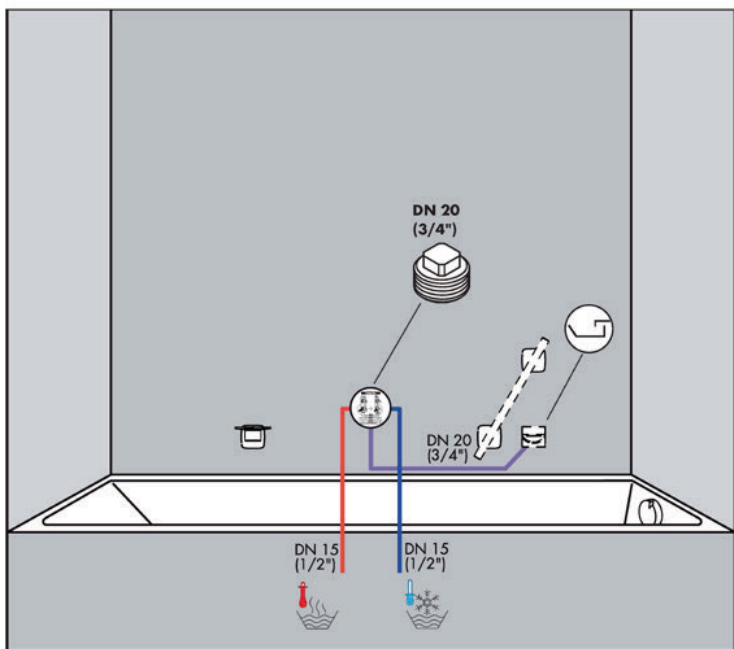

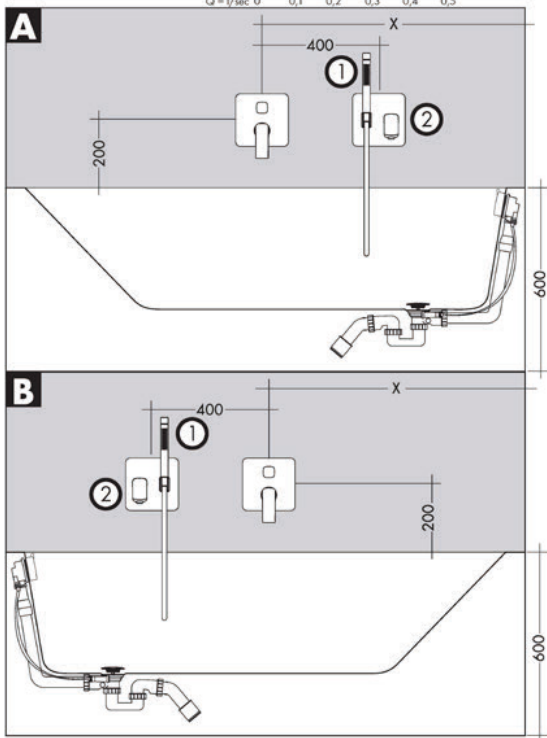
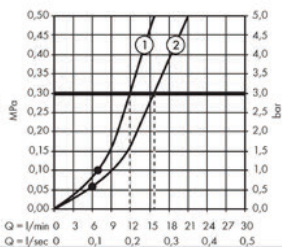
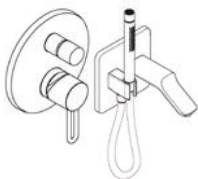

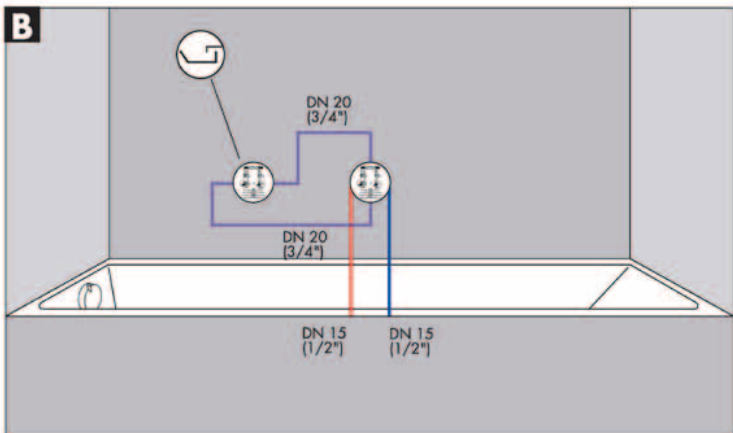
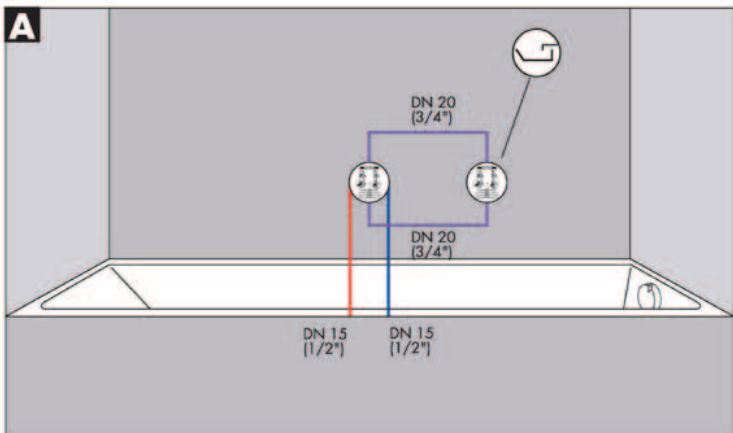

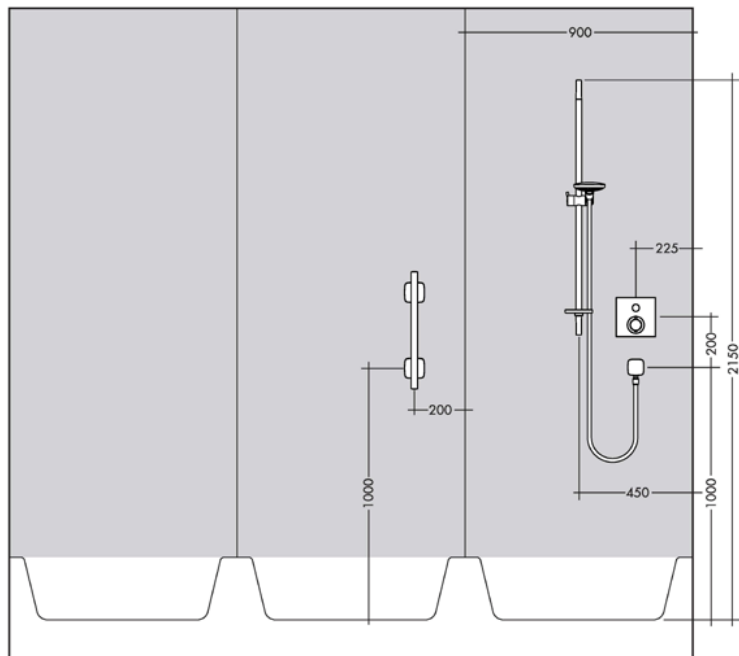
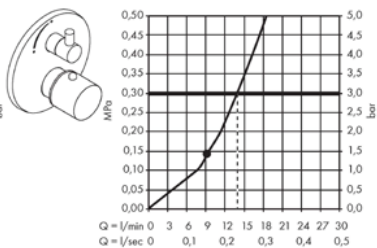
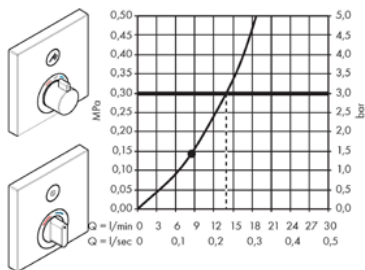

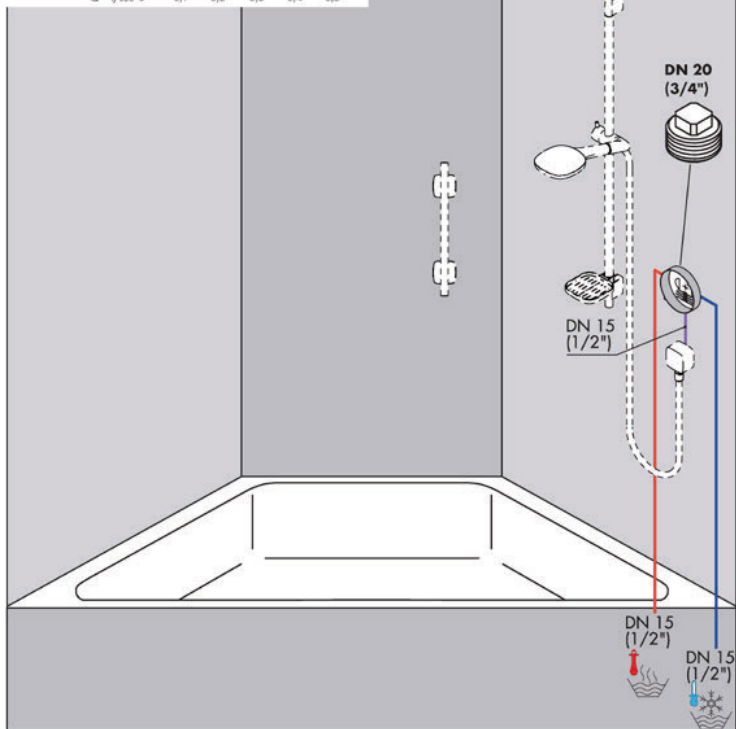
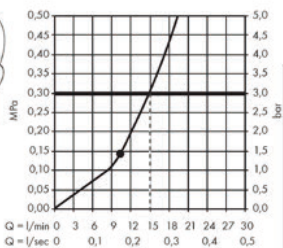

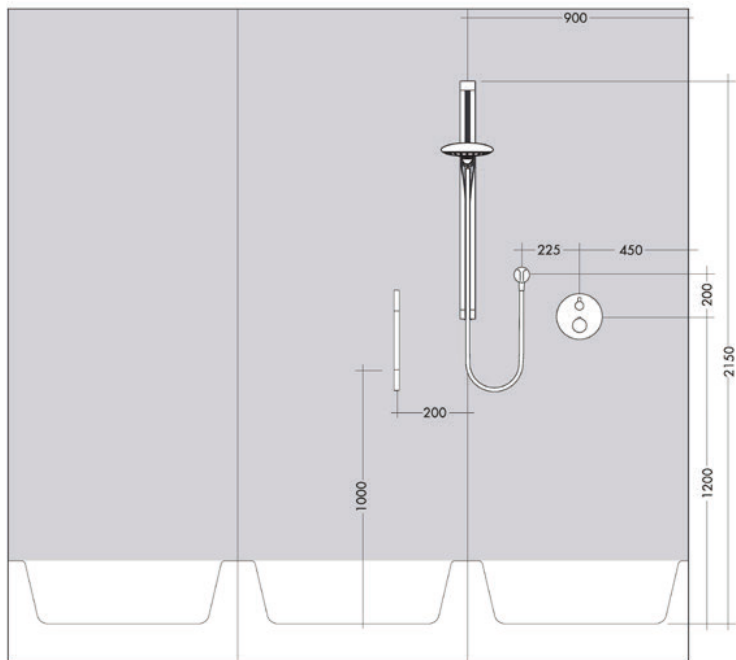
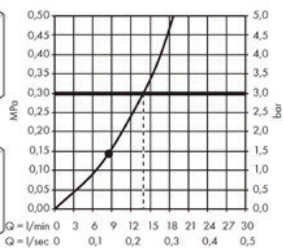
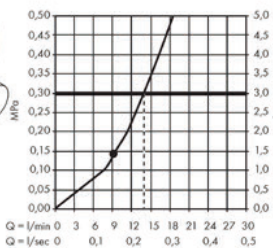

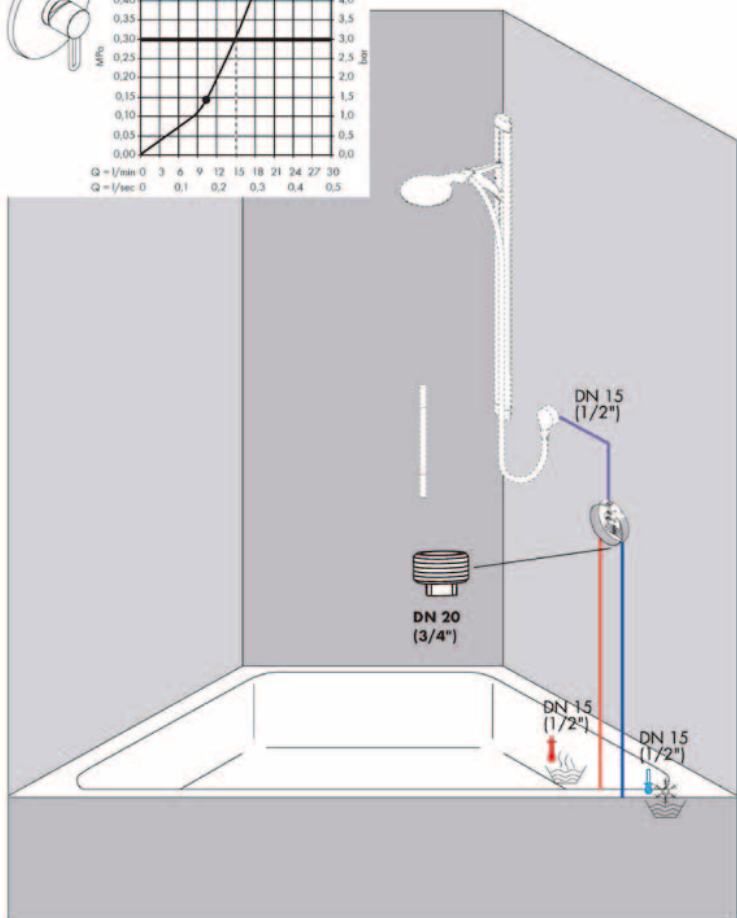
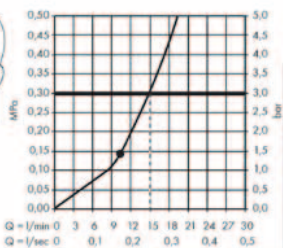

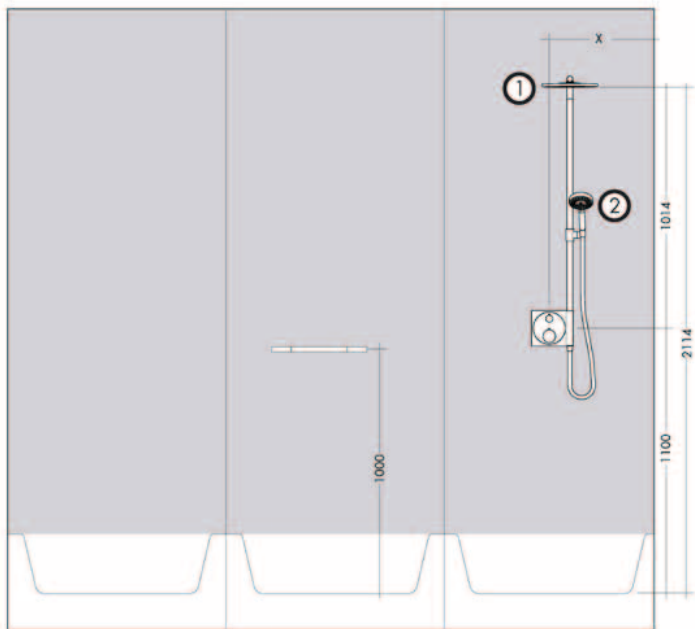
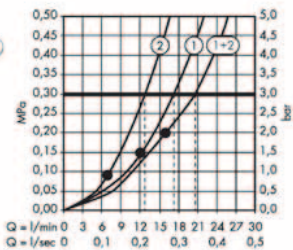

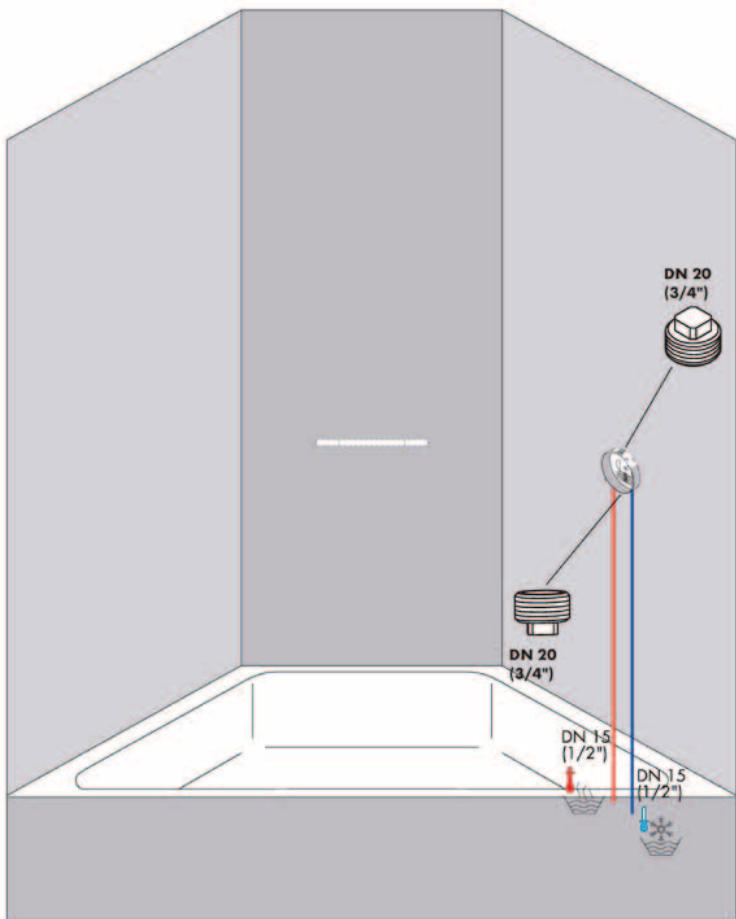

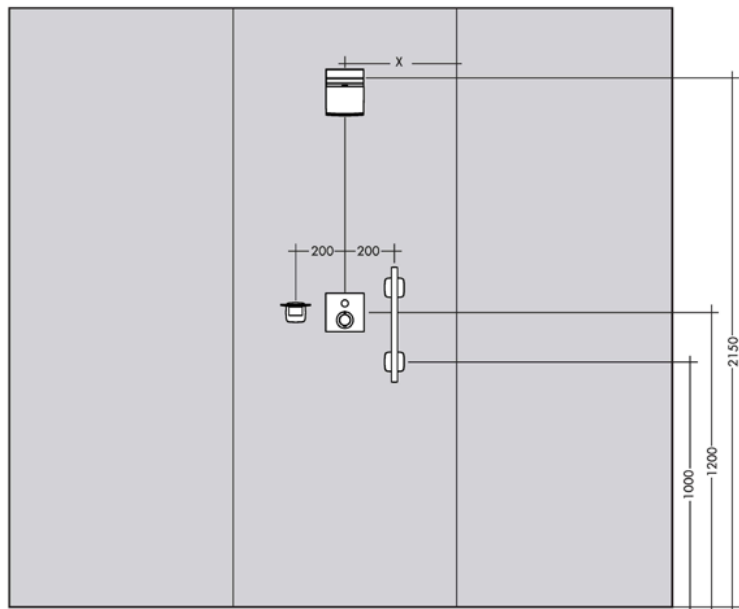
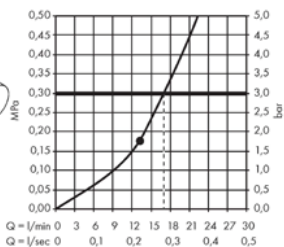
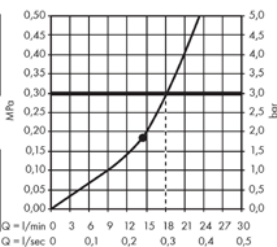

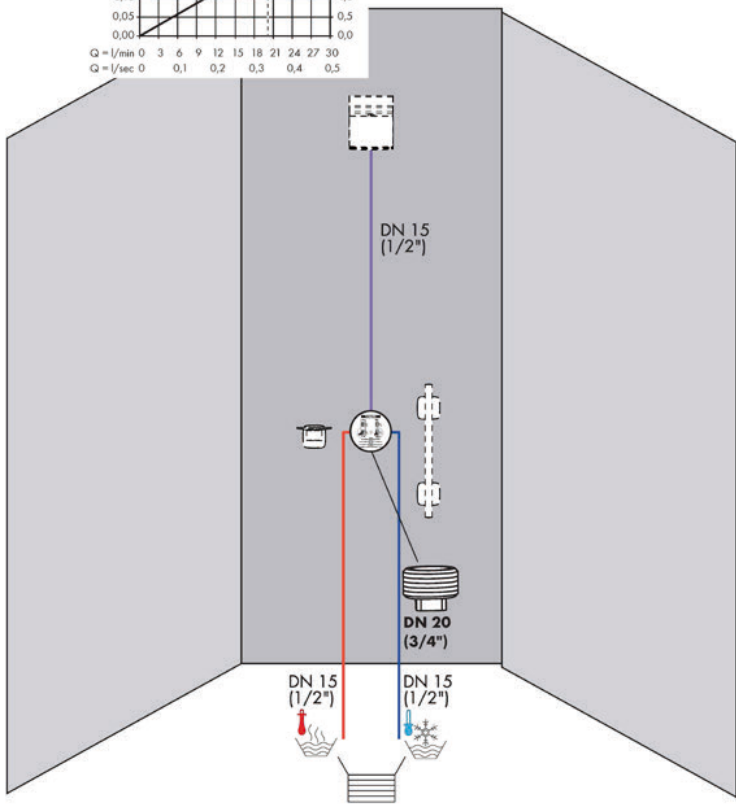
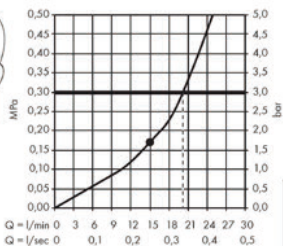

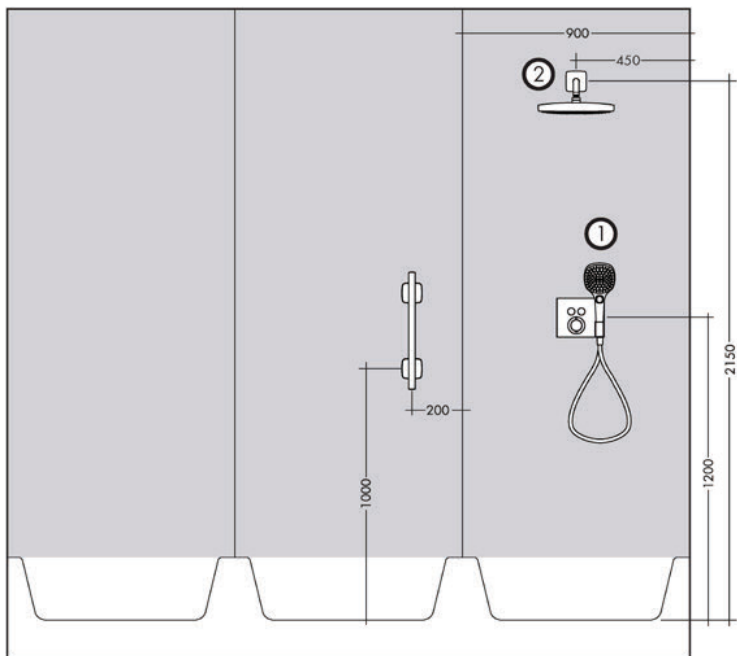
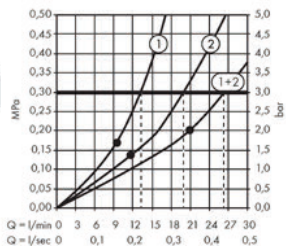
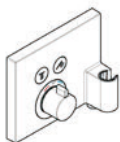

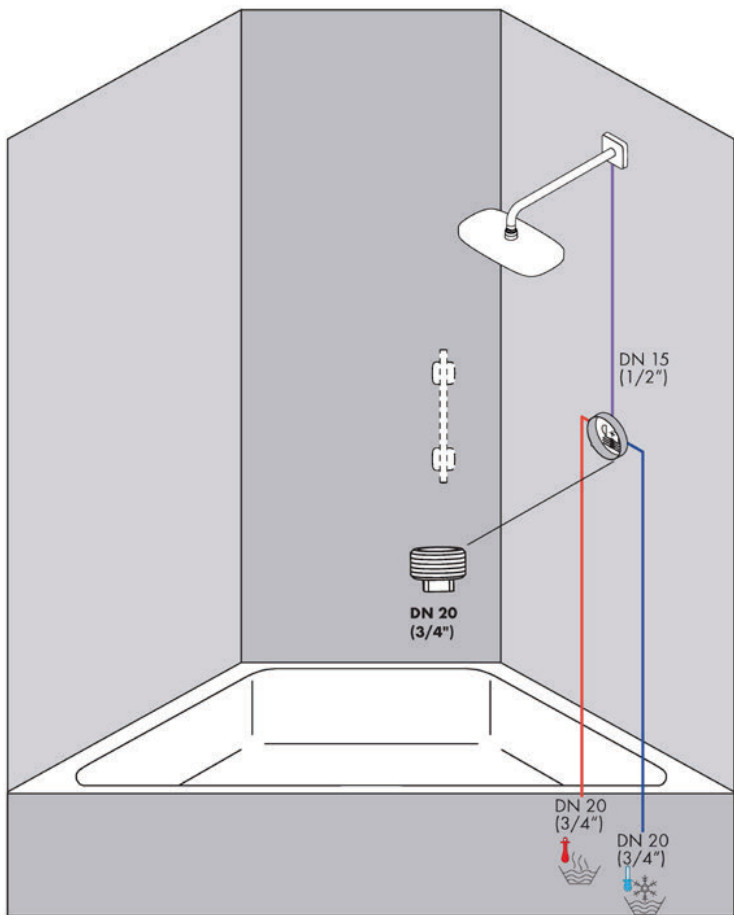

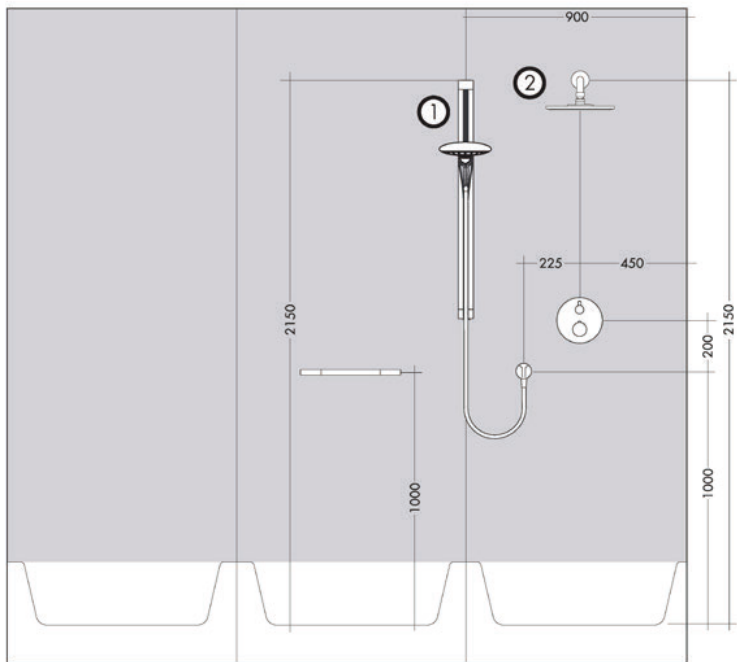
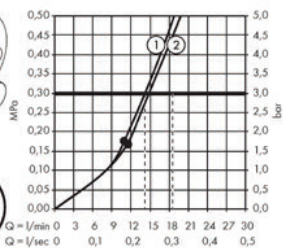
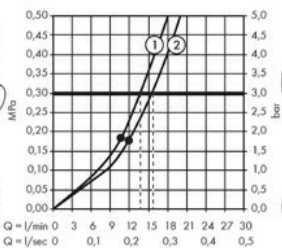

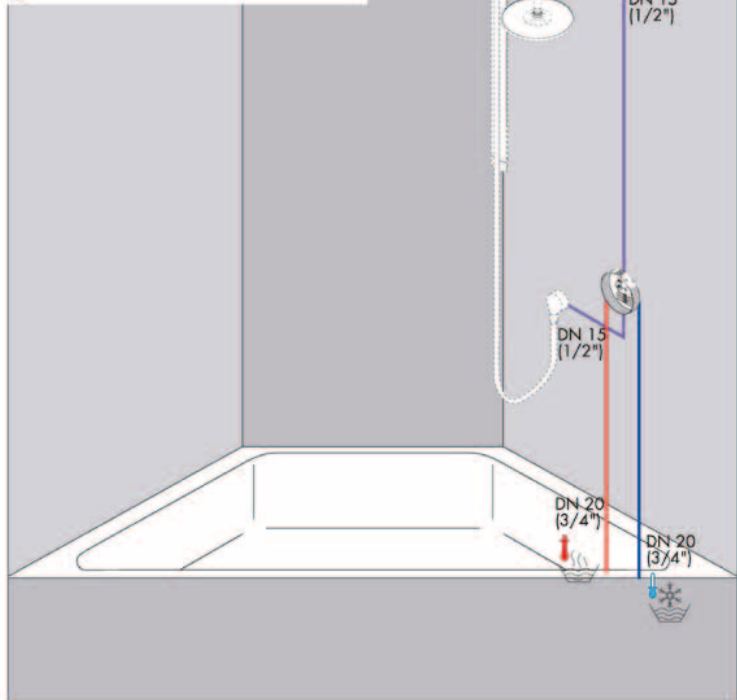
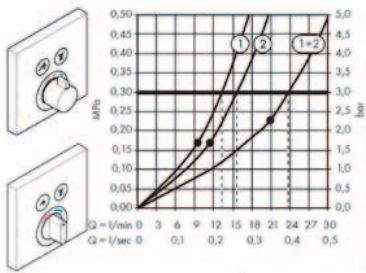

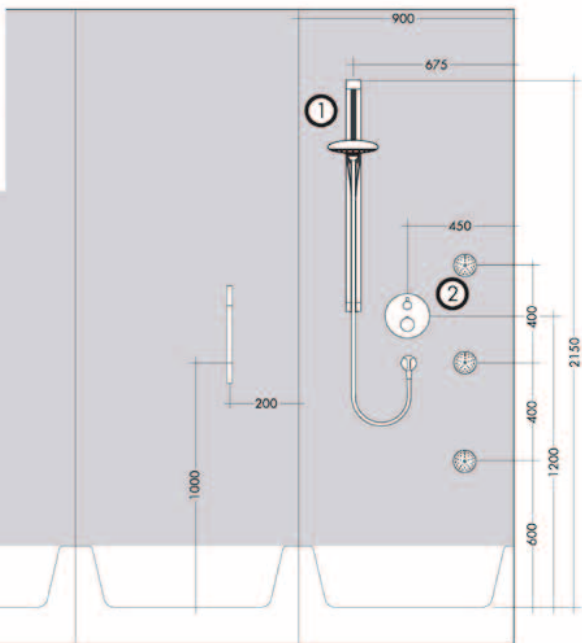
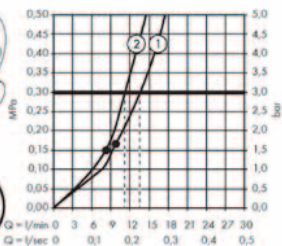
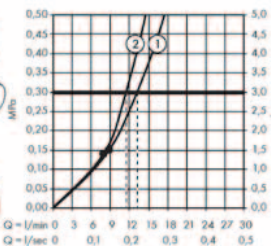

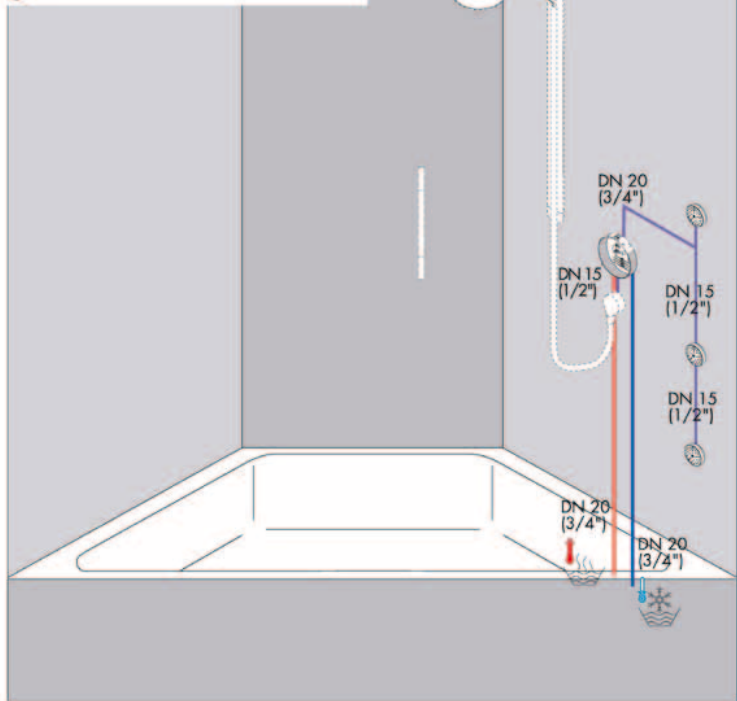
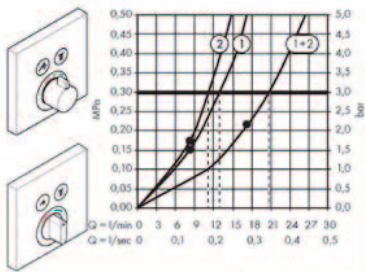

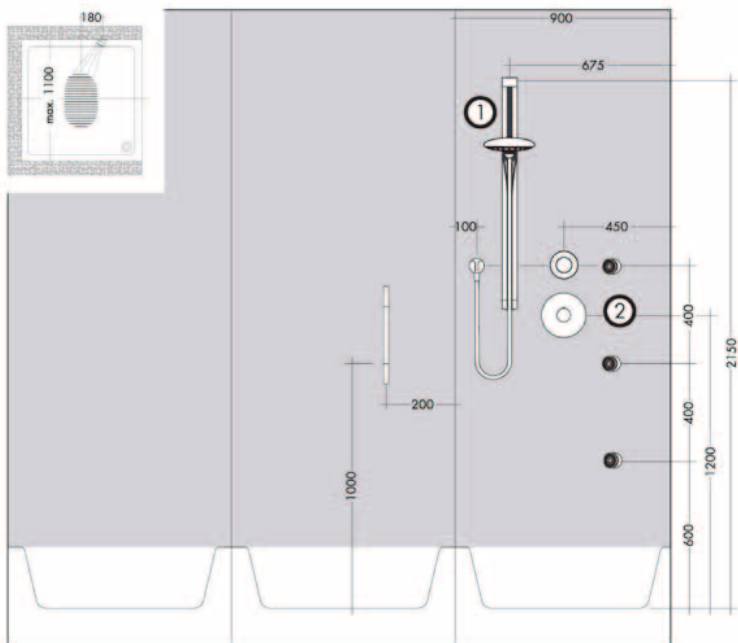
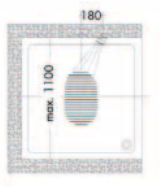
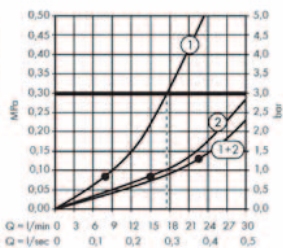

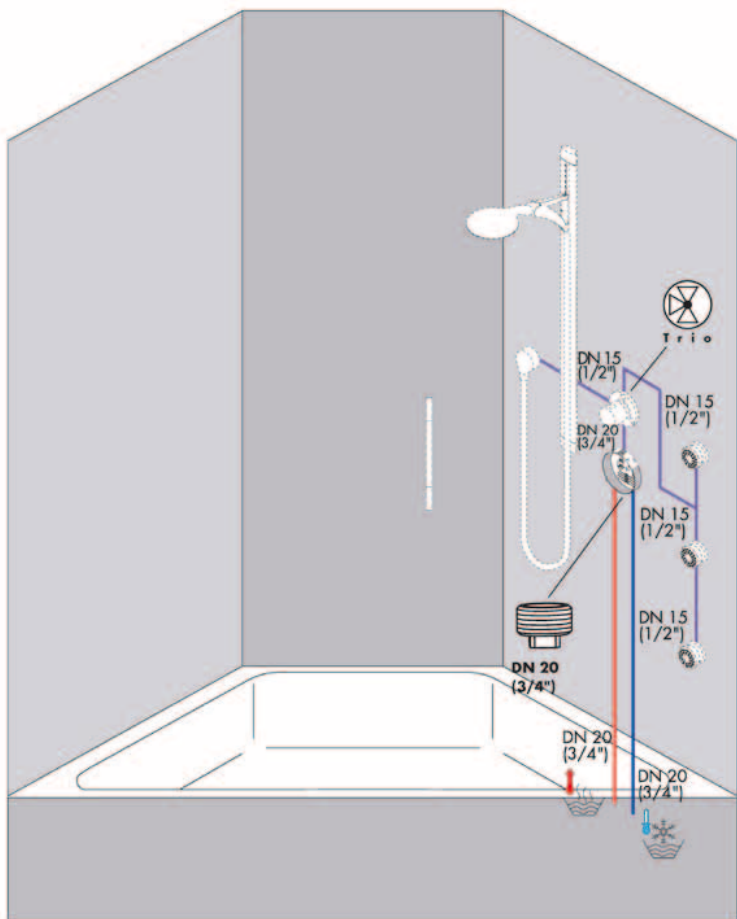

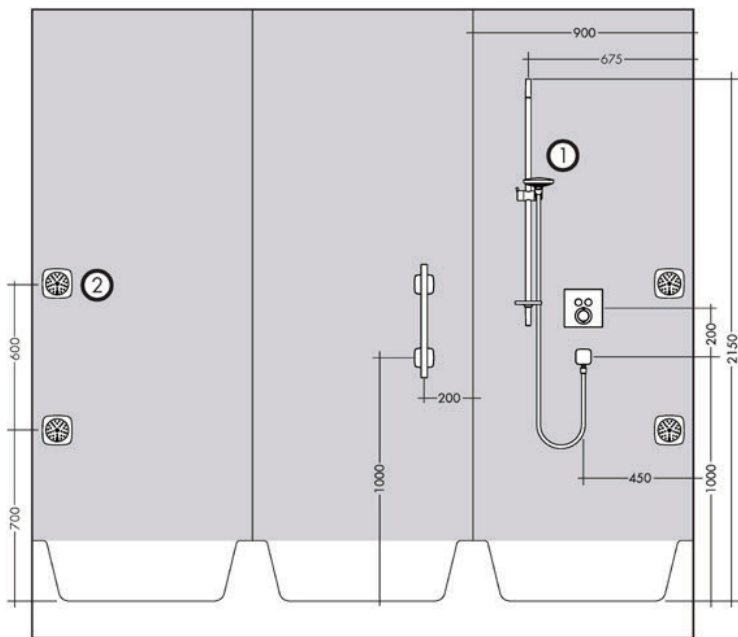
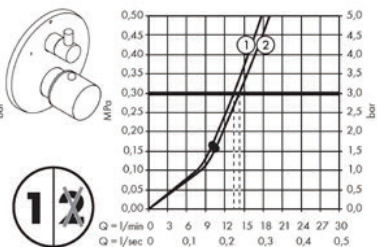
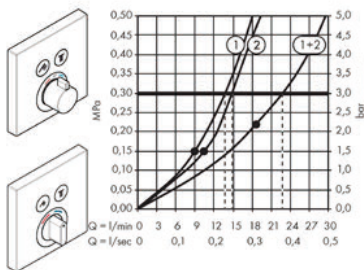

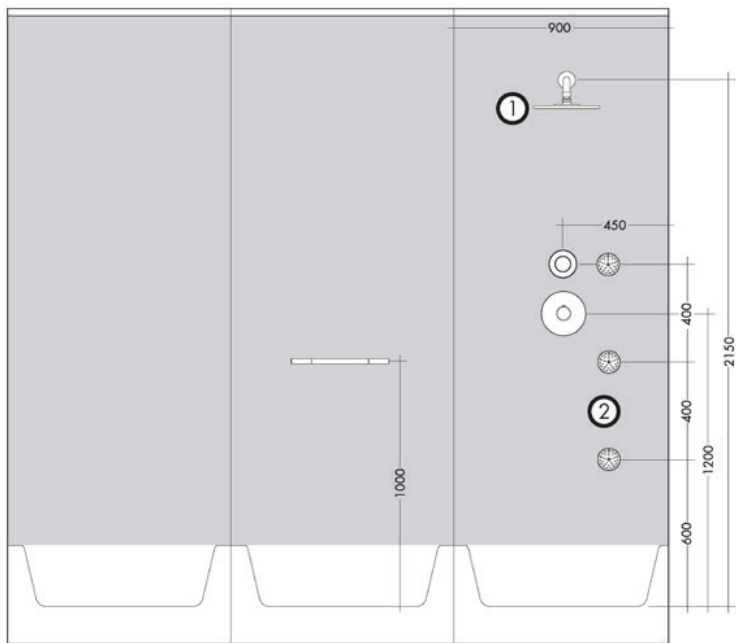
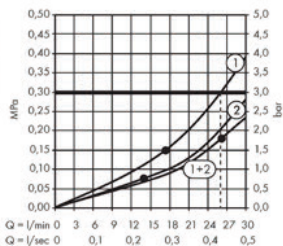

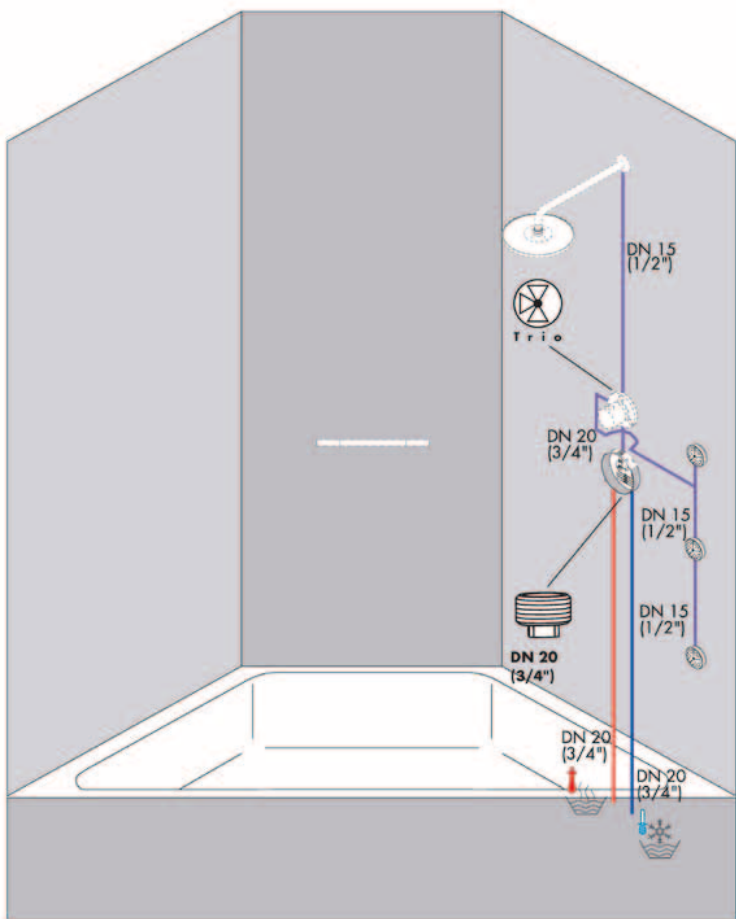

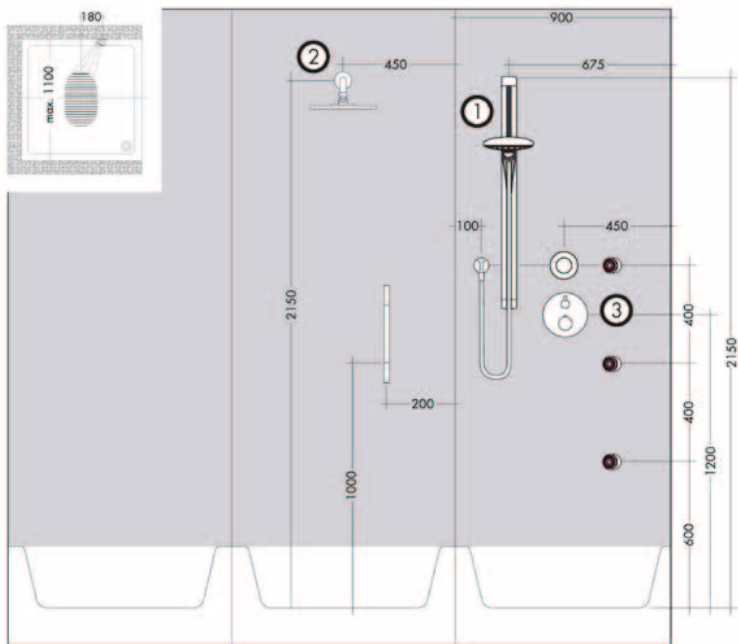
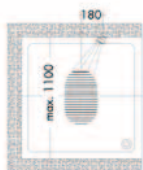
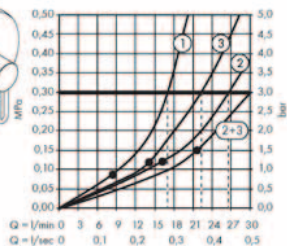
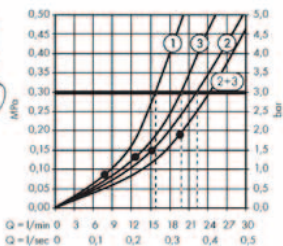

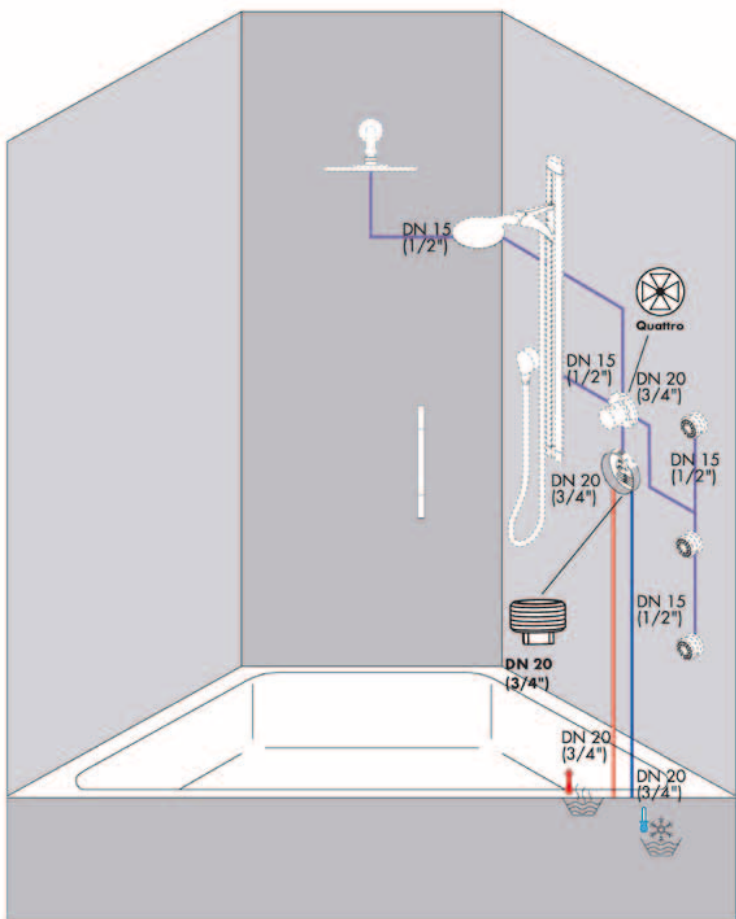

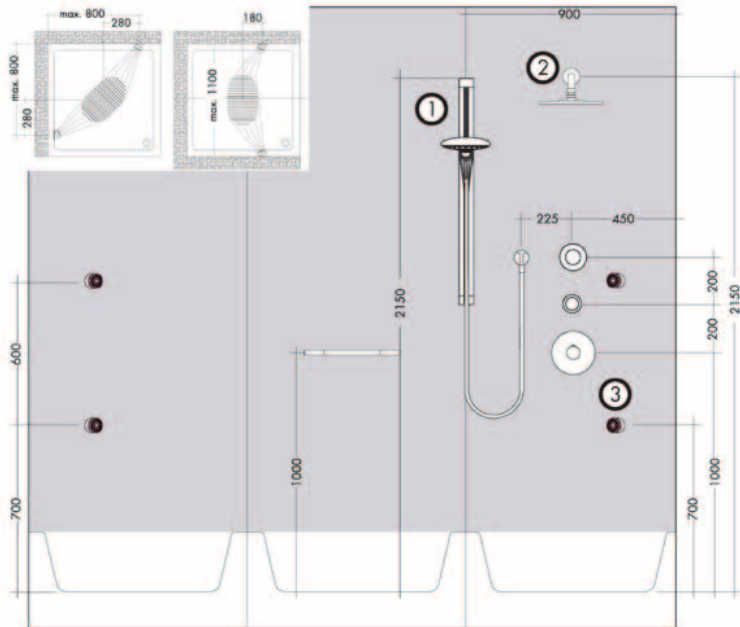
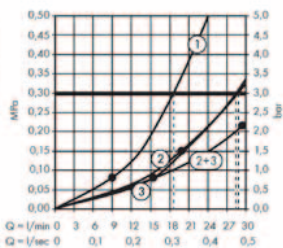

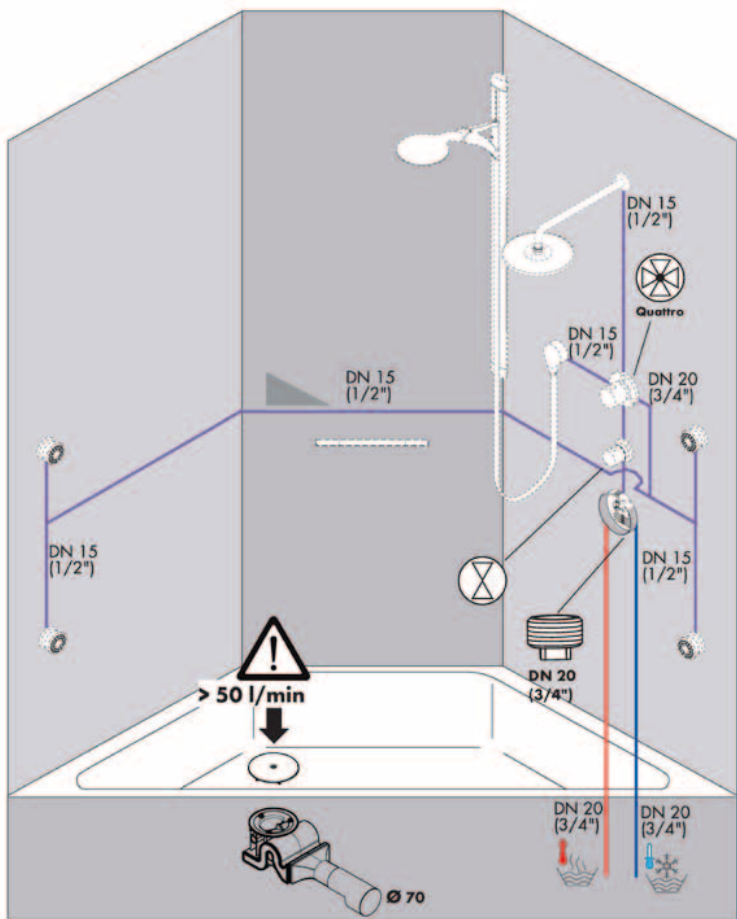

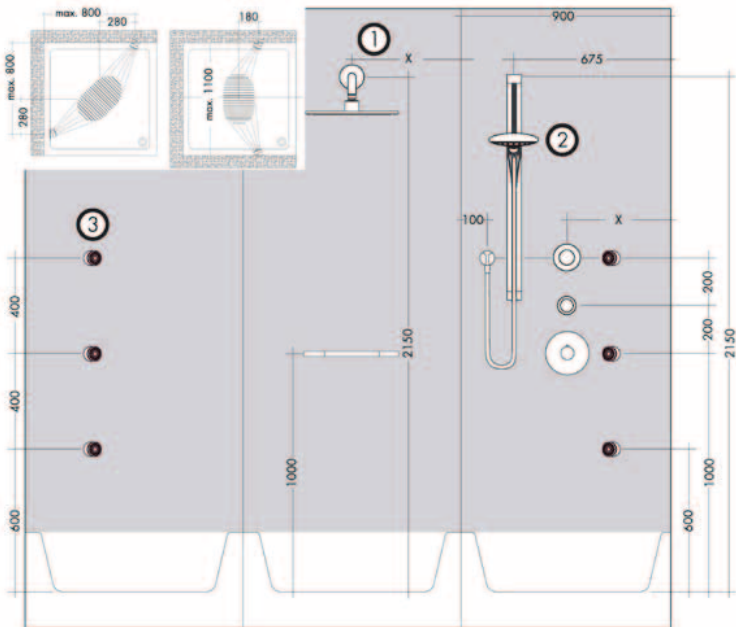
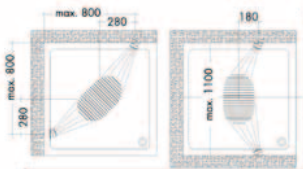
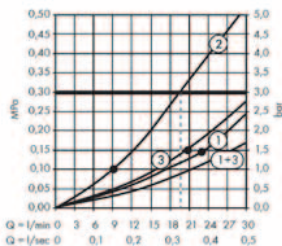

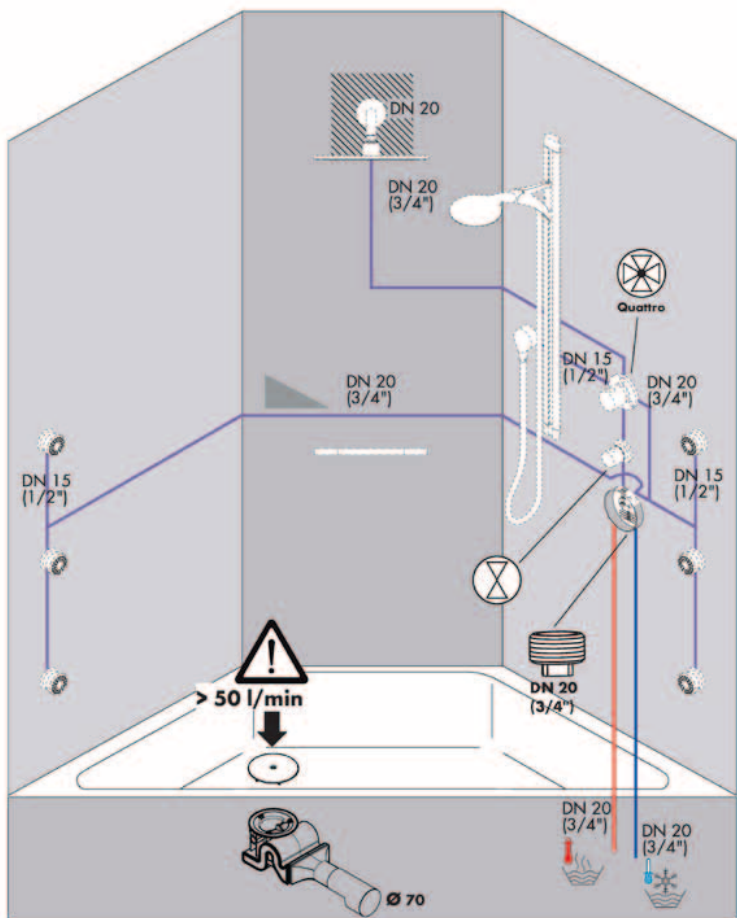

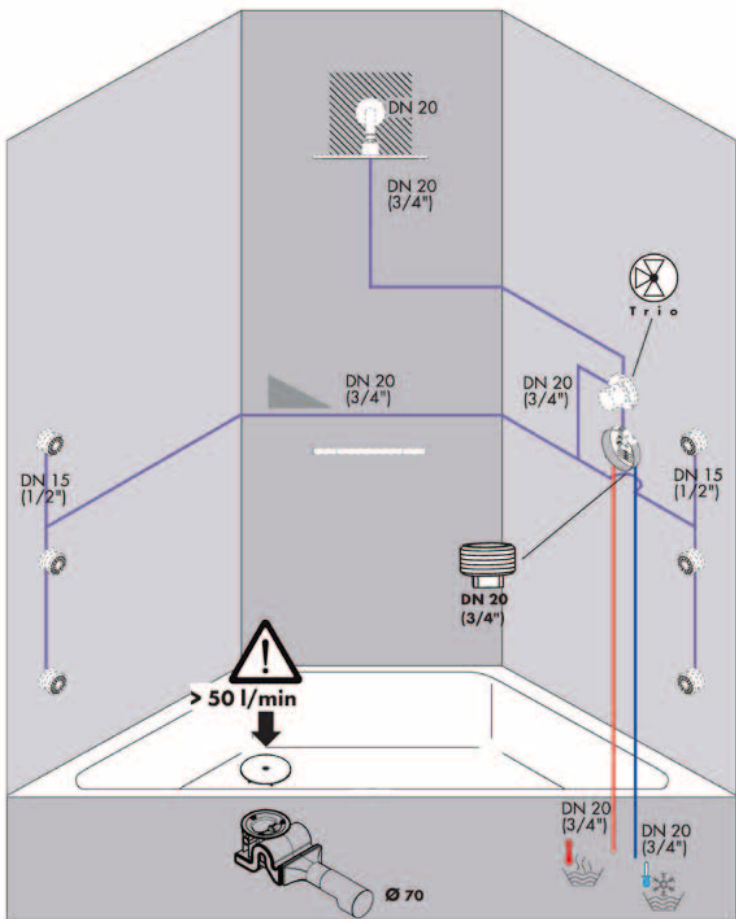

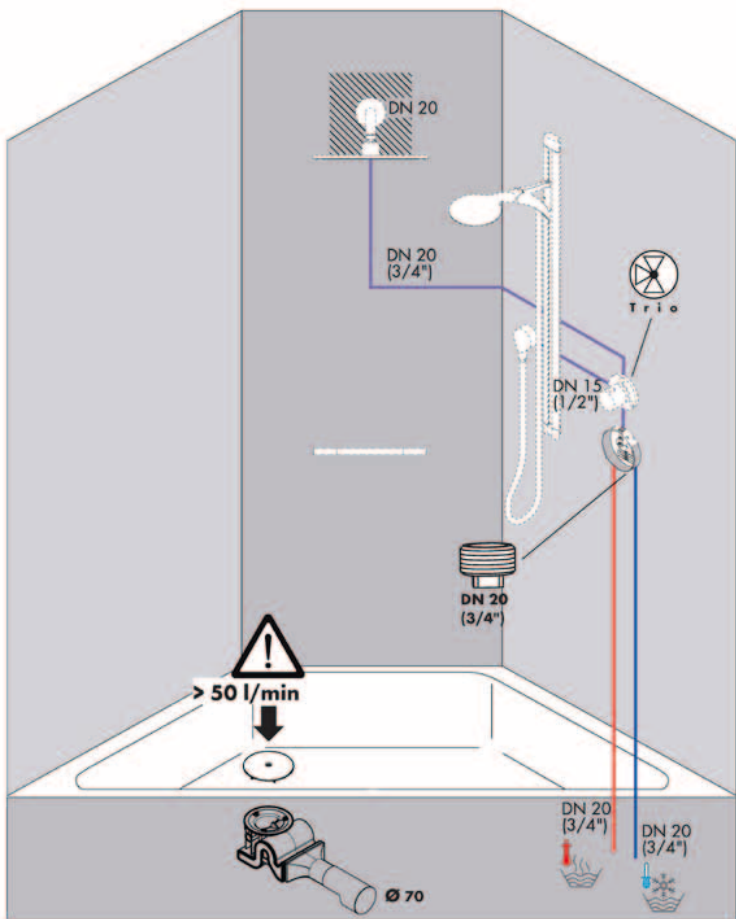

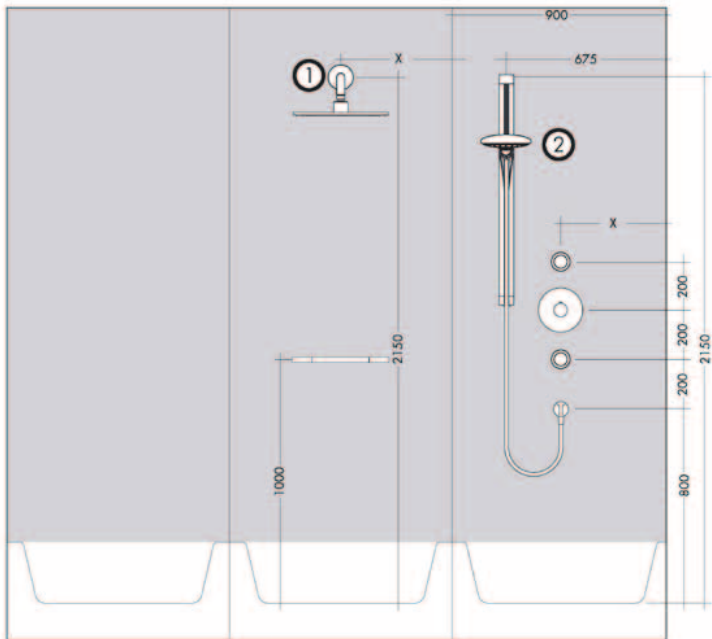
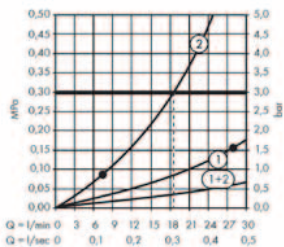

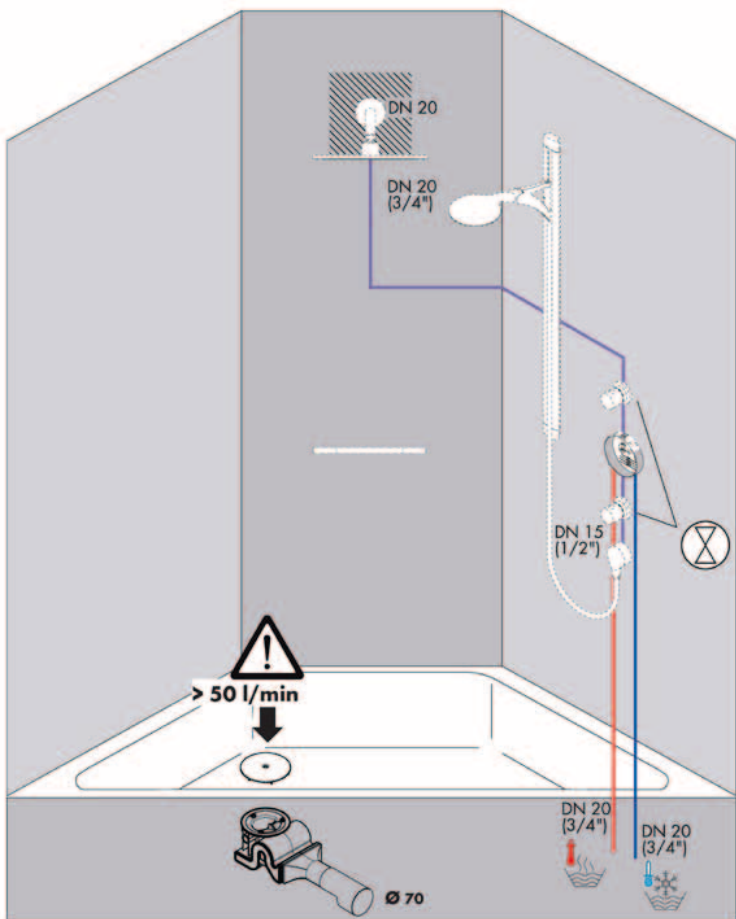

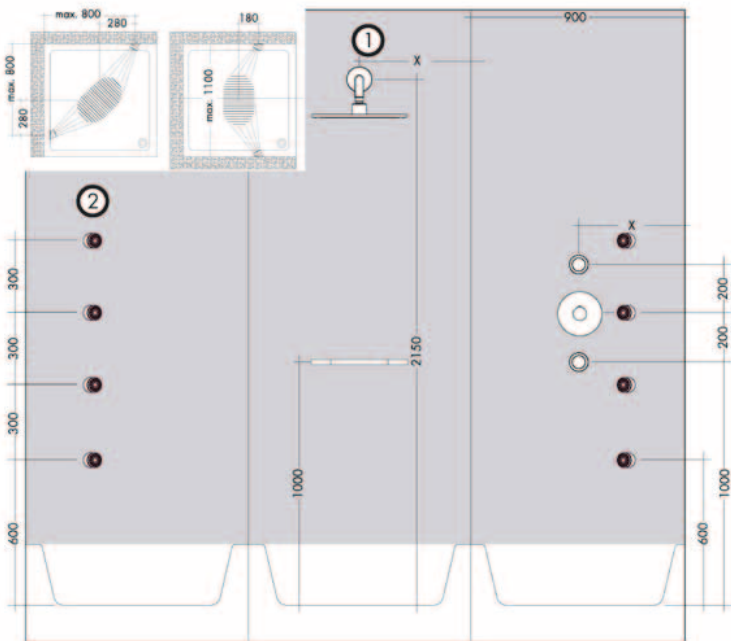
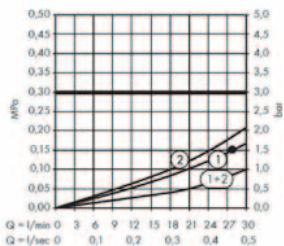

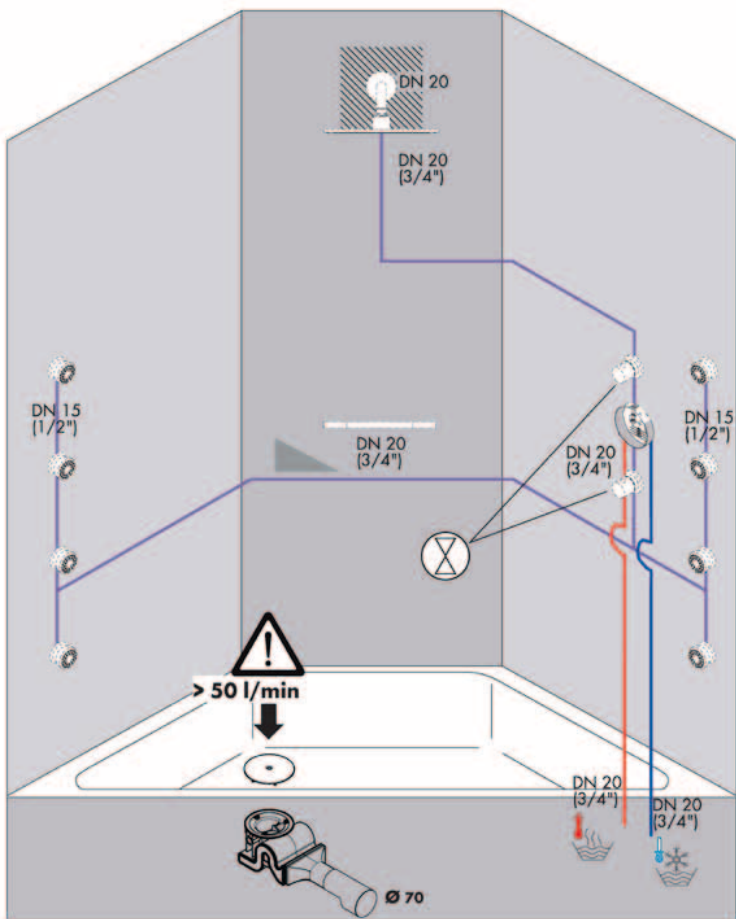

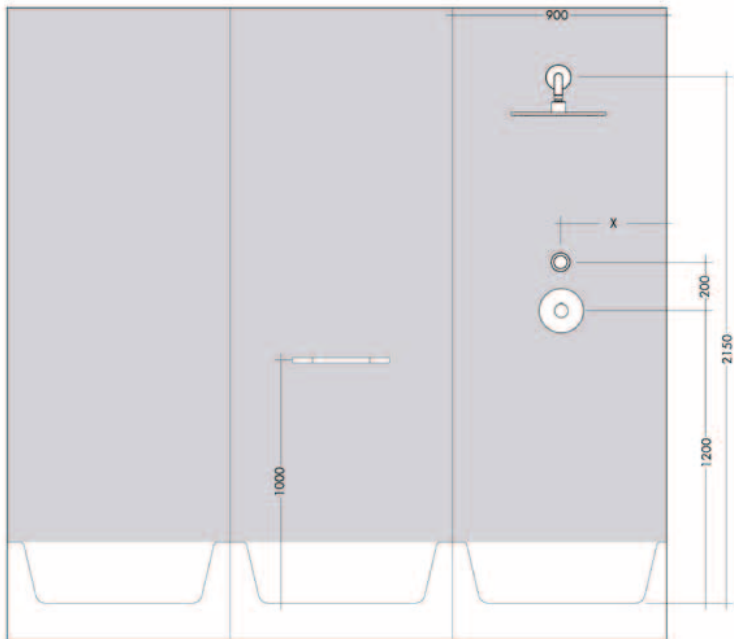
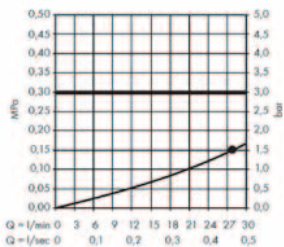

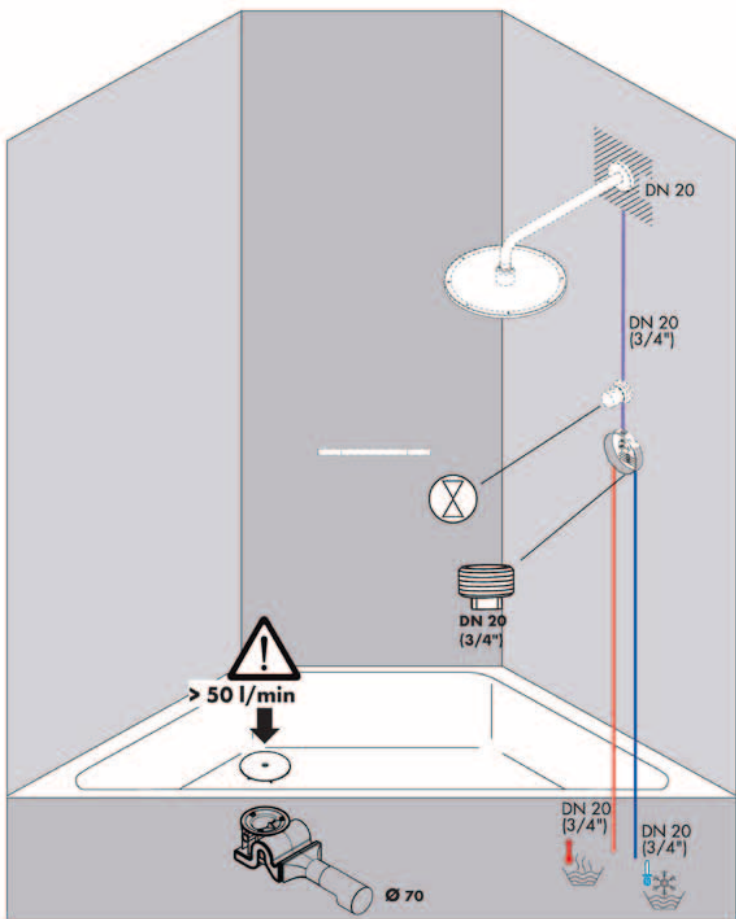

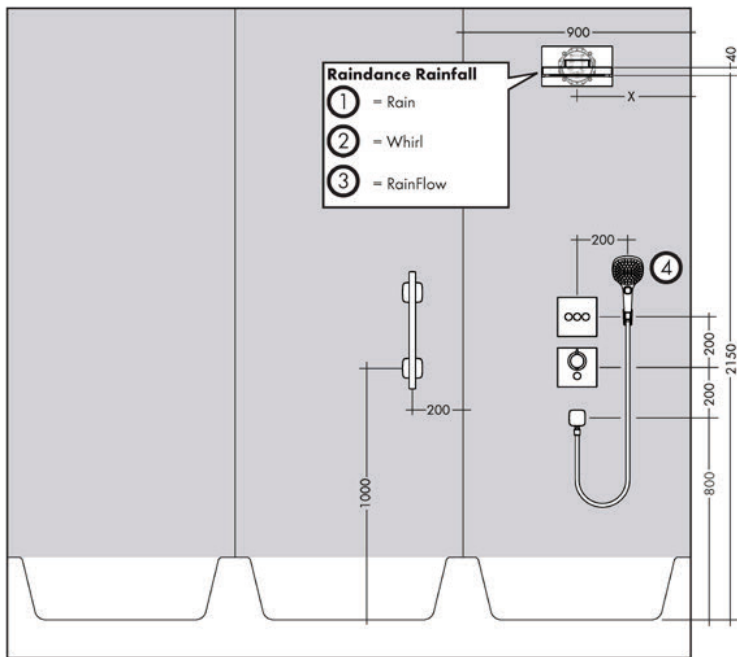
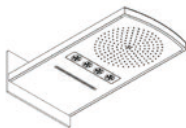
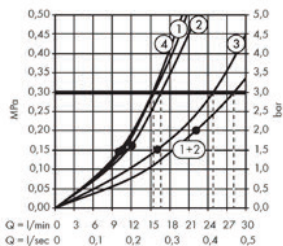
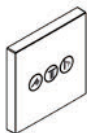

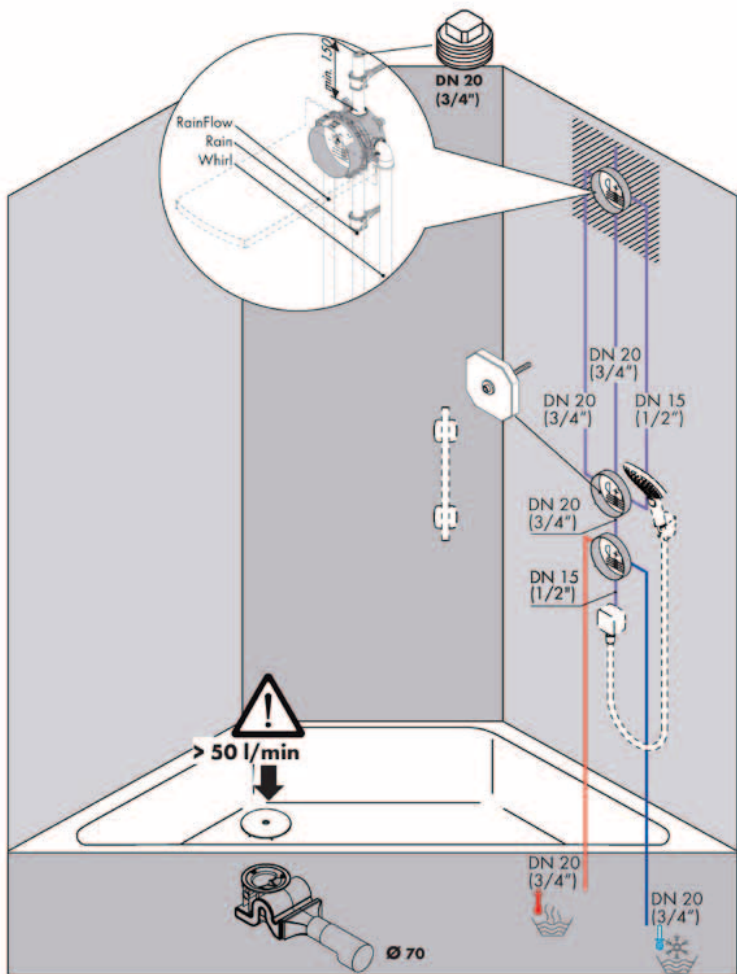

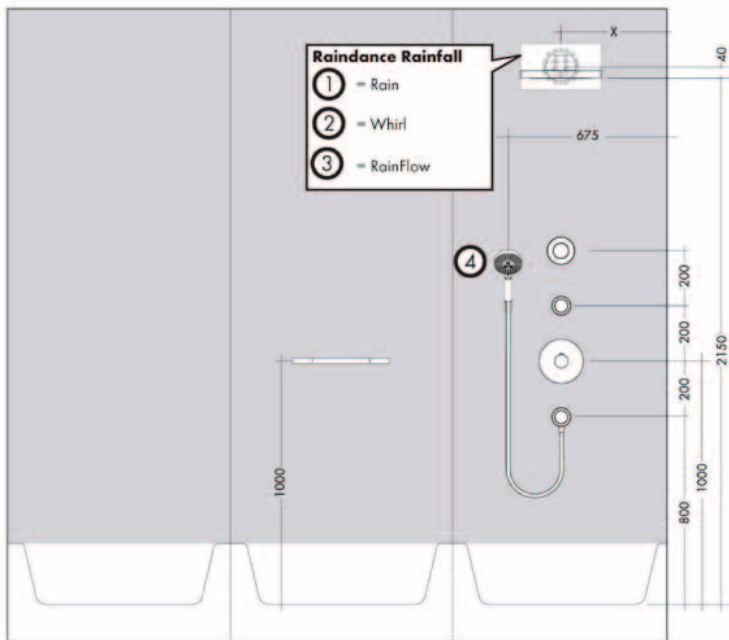
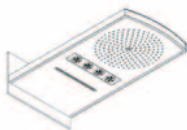
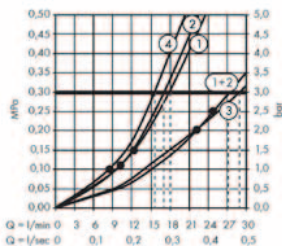

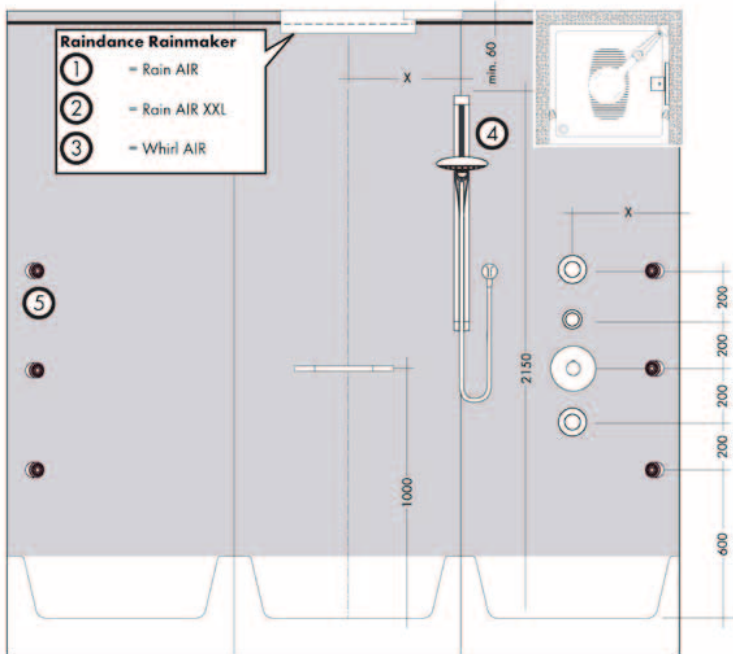
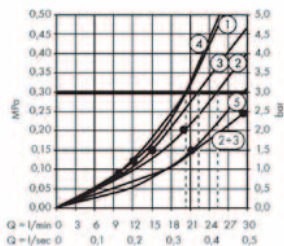

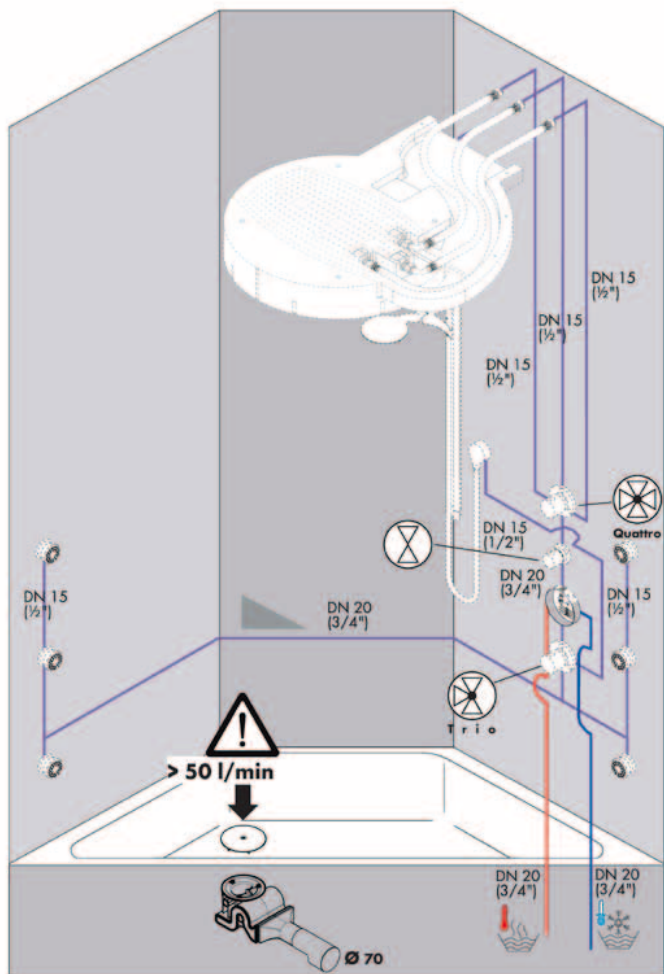

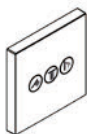

High Flow

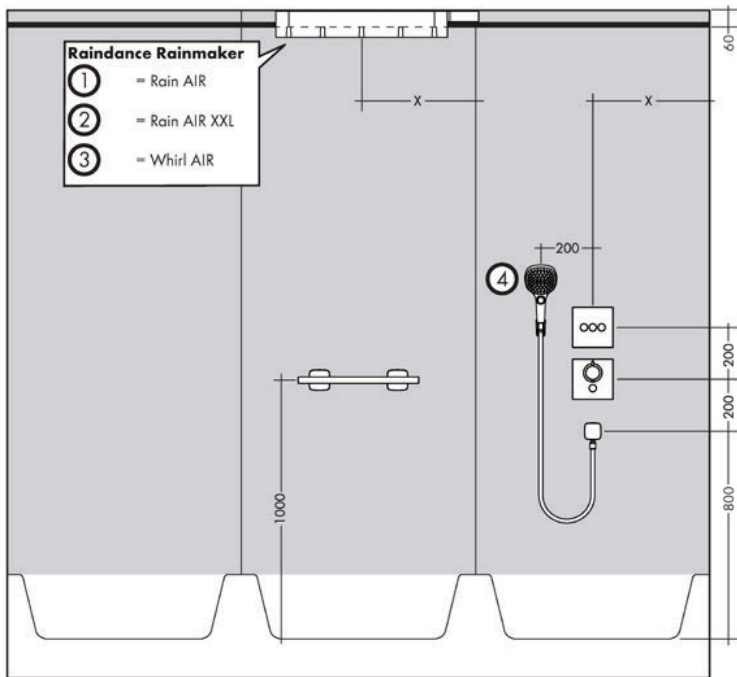
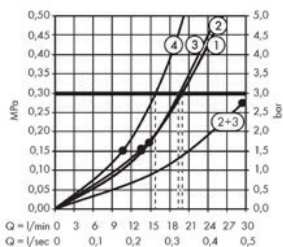

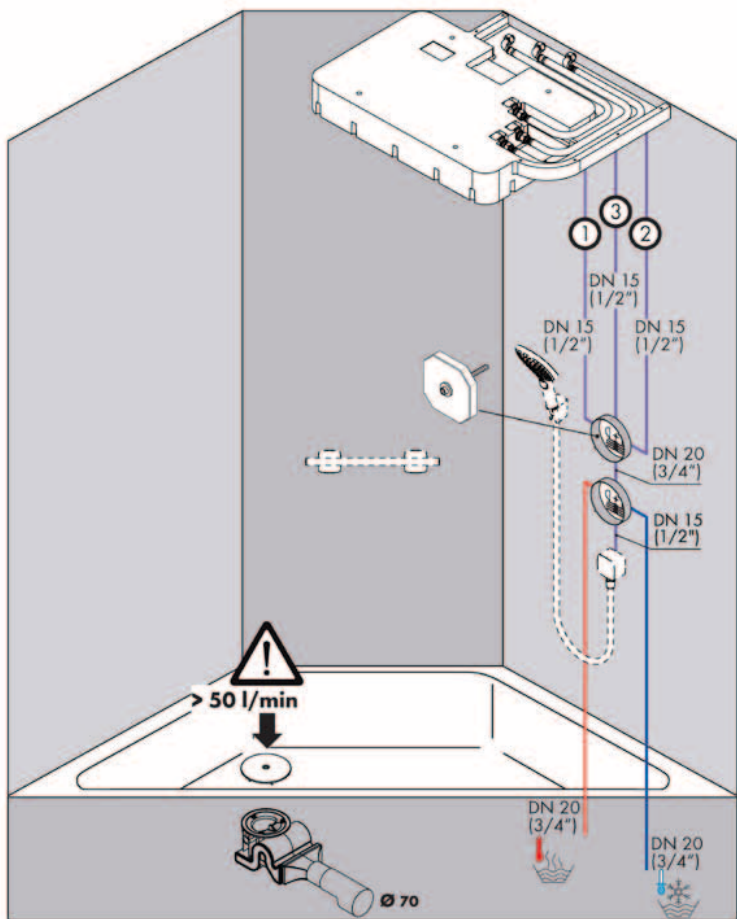

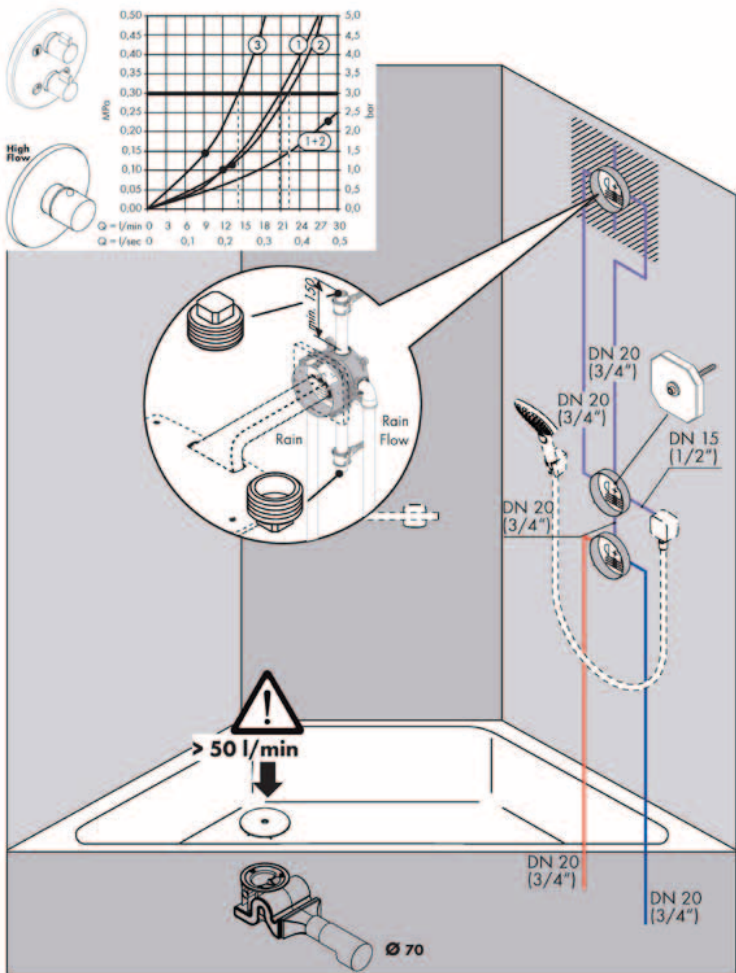

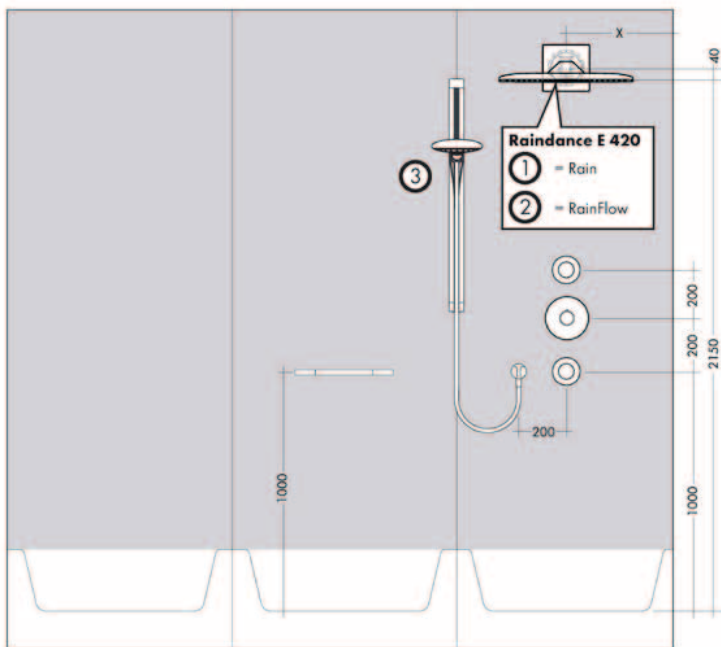
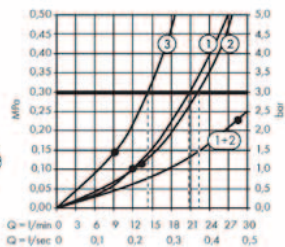
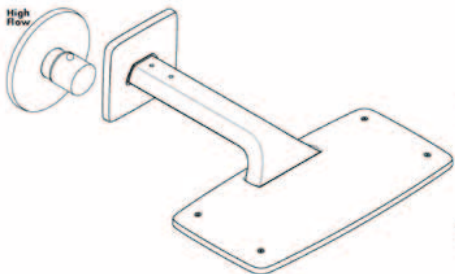

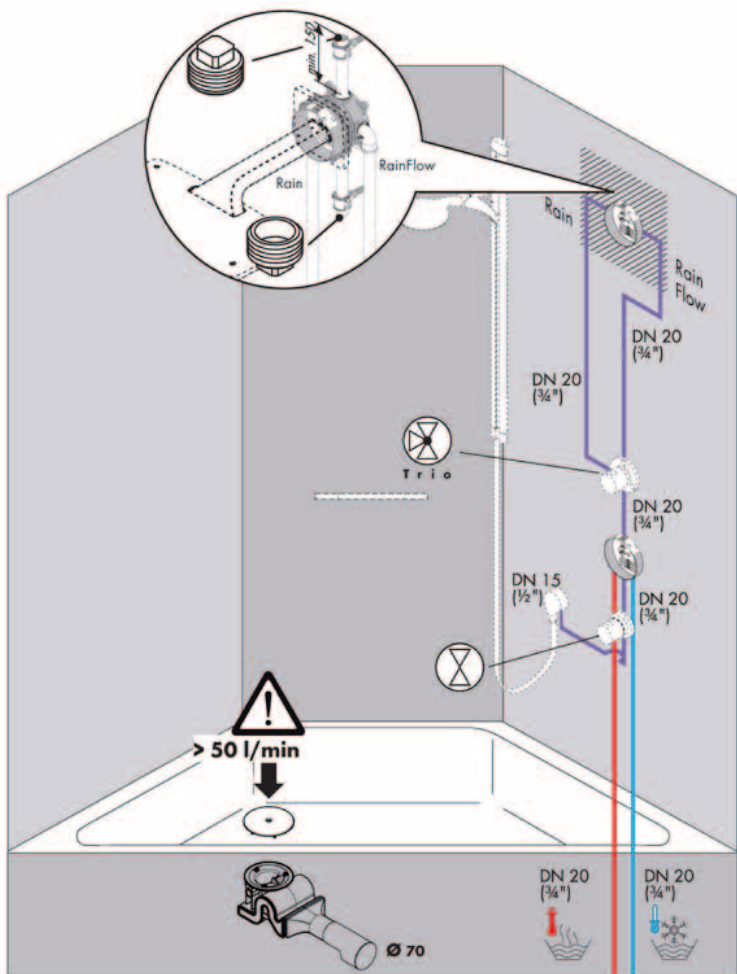

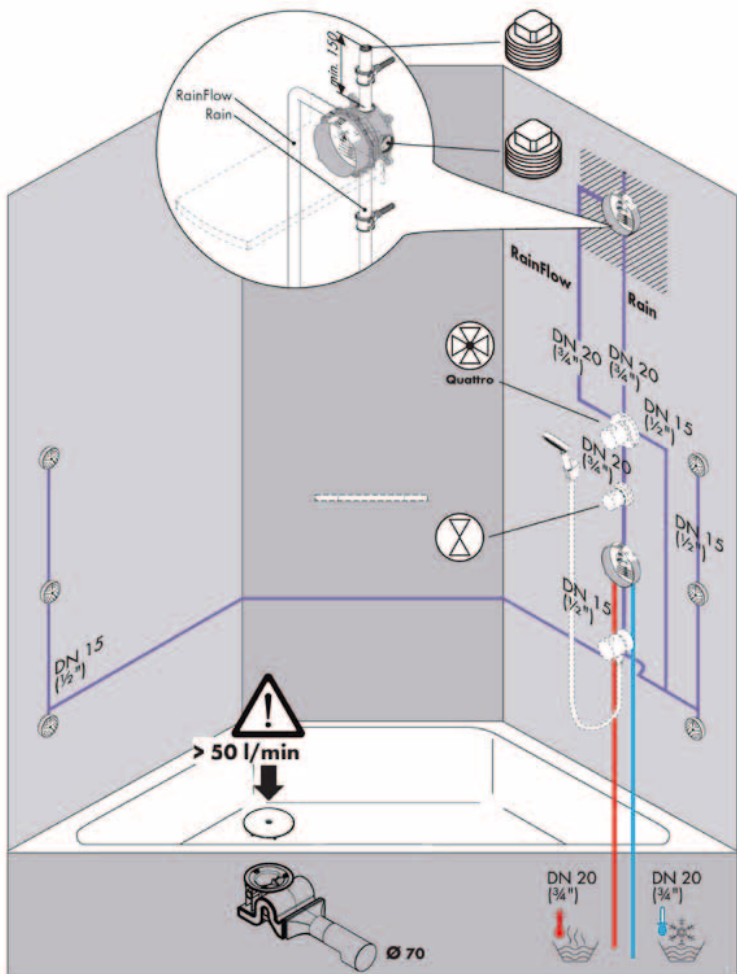

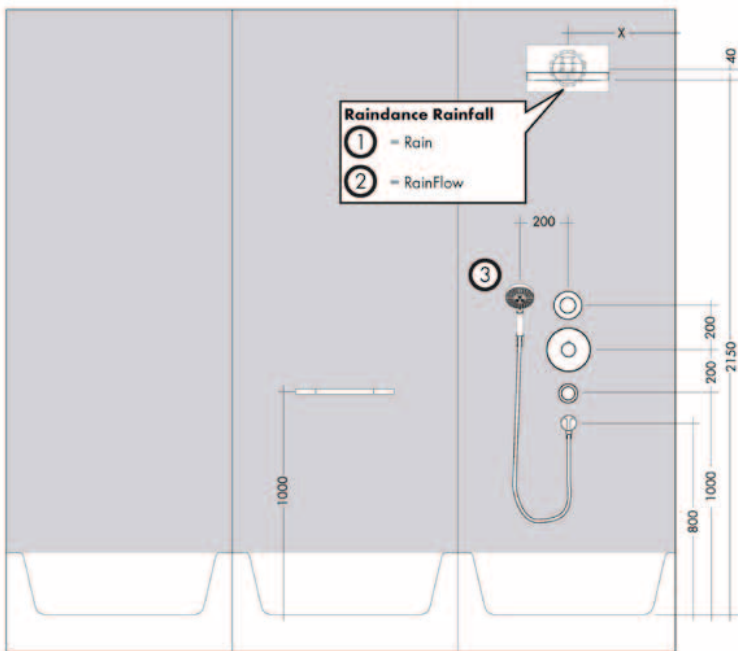
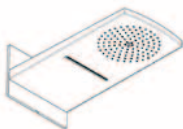
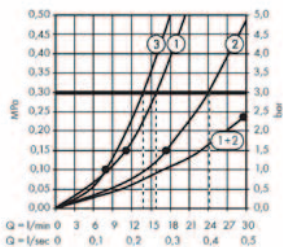

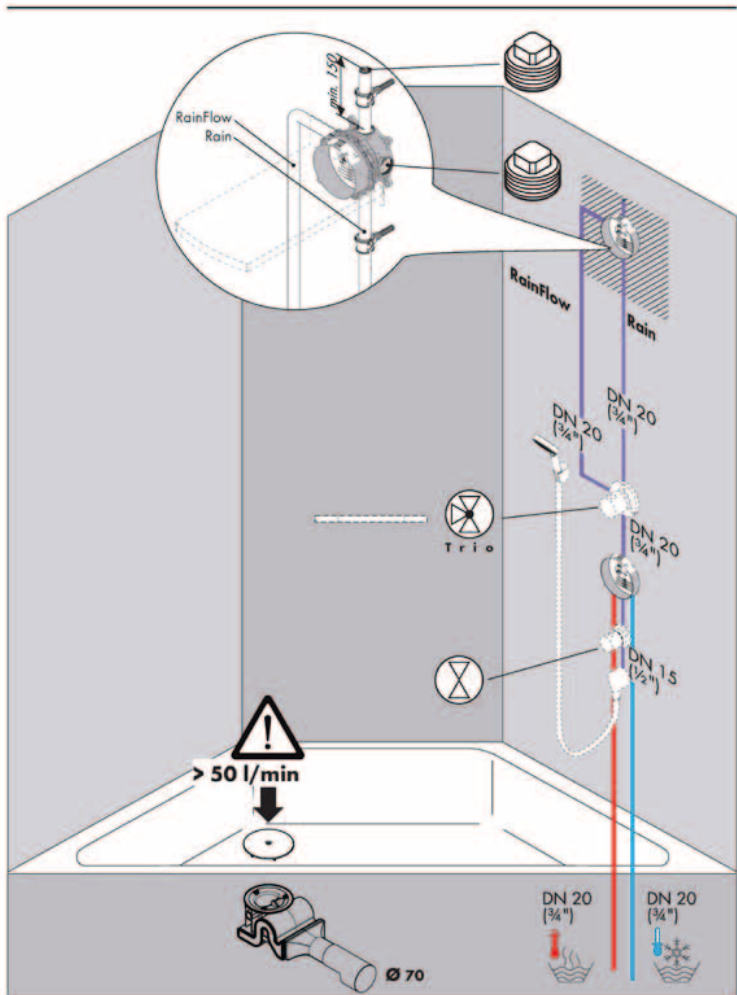

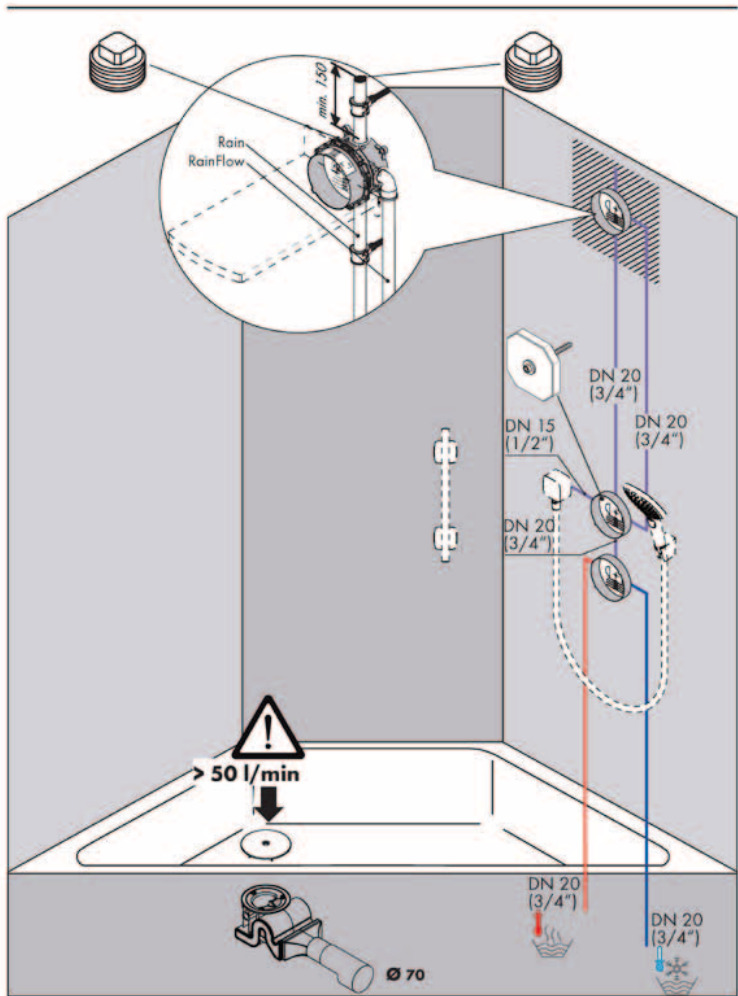

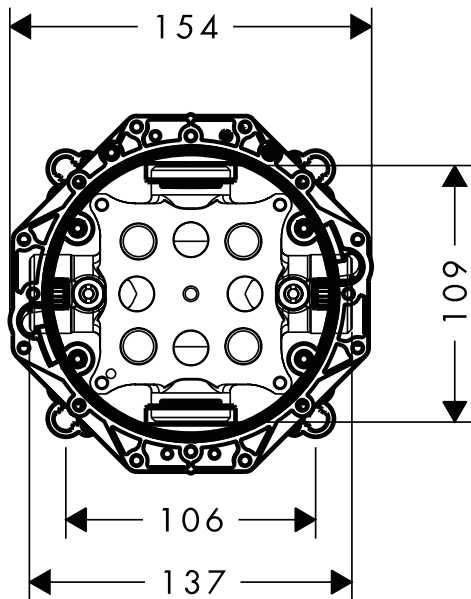
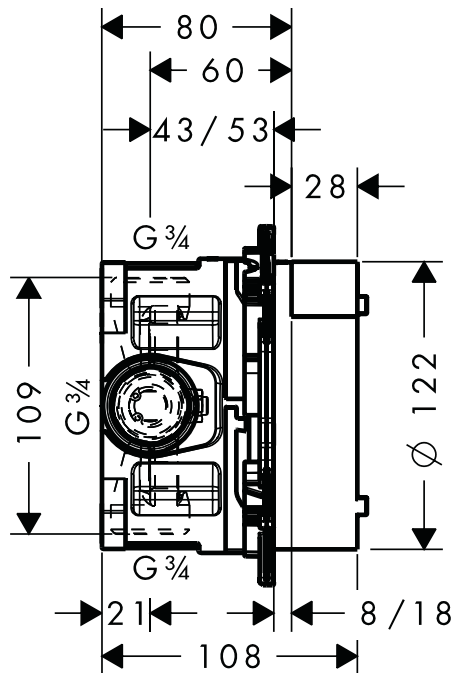

hansgrohe

