

SET LAUFEN PRO B

Washbasin Compact

81495.1



TECHNICAL DATA

Order no.	81495.1
Certified to	EN 31
Dimensions	550 x 400 mm
Inside dimensions of the basin	445 x 240 mm
Specification	Charge 104 – 1 centre tap hole
Weight	11,8 kg
Accessories excl.	Siphon cover, order no. 81995.1 Pedestal, order no. 81995.0
Mounting acc. excl.	Mounting set M10 x 140 mm, order no. 89988.2
Colours	see colour table

SPECIFICATION TEXT

Washbasin Compact LAUFEN PRO B, sanitary ceramic
EN 31

dimensions 550 x 400 mm, symmetric

1 centre tap hole

Special feature: overflow channel glazed

Further options / accessories: Surface refinement LCC (only white),

siphon cover, pedestal, bathtubs, furniture

Order no. 81495.1

TECHNICAL DRAWINGS / S 1 : 20

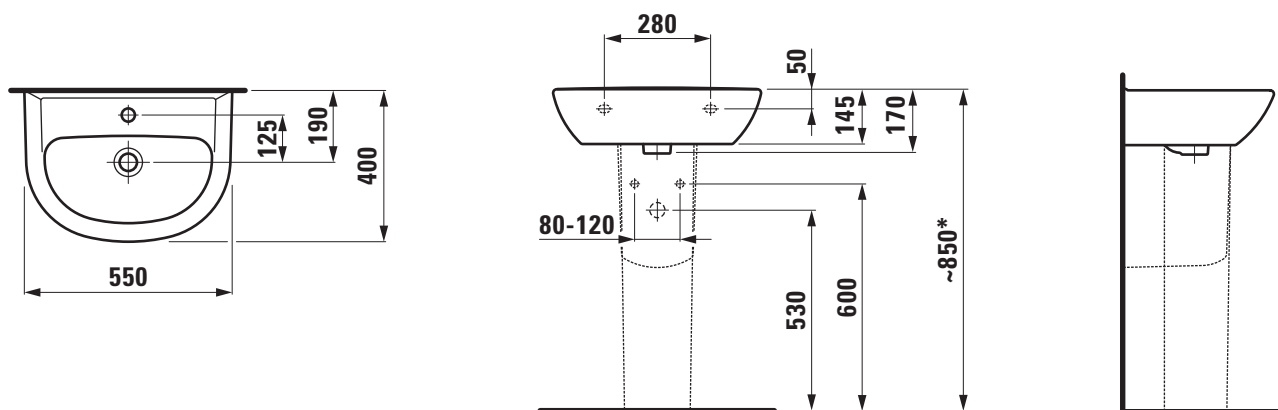

* = Effective height must be fixed according to the height of the pedestal.