

SET LAUFEN PRO S

Countertop basin

81396.5



TECHNICAL DATA

Order no.	81396.5
Certified to	EN 31
Dimensions	850 x 460 mm
Inside dimensions of the basin	670 x 285 mm
Specification	Charge 104 – 1 centre tap hole
Special specification	Charge 108 – 3 tap holes Charge 109 – without tap hole Charge 111 – 1 centre tap hole, without overflow Charge 112 – without tap holes, without overflow Charge 136 – 3 tap holes, distance 8 inches Charge 158 – 3 tap holes, without overflow
Weight	21,7 kg
Accessories excl.	Siphon cover, order no. 81996.3 (3 tap holes not possible) Pedestal, order no. 81996.2 Towel rack, order no. 38196.0.004.410.1

Mounting acc. excl. Mounting set M10 x 140 mm, order no. 89988.2

Colours see colour table

SPECIFICATION TEXT

Countertop basin LAUFEN PRO S, sanitary ceramic EN 31, dimensions 850 x 460 mm, angular

1 centre tap hole

Special feature: overflow channel glazed

Further options / accessories: Surface refinement LCC (only white), 3 tap holes, without tap holes, 1 tap hole without overflow, without tap holes and overflow, 3 tap holes distance 8 inches, 3 tap holes without overflow, siphon cover, pedestal, towel rack, bathtubs, furniture
Order no. 81396.5

TECHNICAL DRAWINGS / S 1 : 20

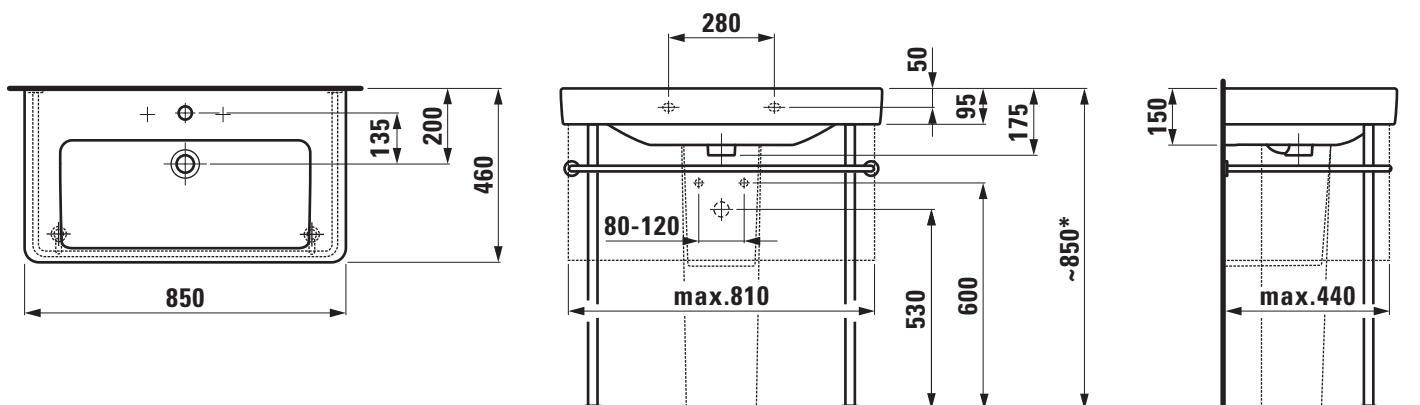

* = Effective height must be fixed according to the height of the pedestal.