

DE / Montageanleitung	02
FR / Instructions de montage	03
EN / assembly instructions	04
IT / Istruzioni per Installazione	05
ES / Instrucciones de montaje	06
NL / Handleiding	07
DK / Monteringsvejledning	08
PT / Manual de Instalação	09
PL / Instrukcja montażu	10
CS / Montážní návod	11
SK / Montážny návod	12
ZH / 组装说明	13
RU / Инструкция по монтажу	14
HU / Szerelési útmutató	15
FI / Asennusohje	16
SV / Monteringsanvisning	17
LT / Montavimo instrukcijos	18
HR / Uputstva za instalaciju	19
TR / Montaj kılavuzu	20
RO / Instrucțiuni de montare	21
EL / Οδηγία συναρμολόγησης	22
SL / Navodila za montažo	23
ET / Paigaldusjuhend	24
LV / Montāžas instrukcija	25
SR / Uputstvo za montažu	26
NO / Montasjeveiledning	27
BG / Ръководство за монтаж	28
SQ / Udhëzime rreth montimit	29
AR / عميلنا تاميلعت	30

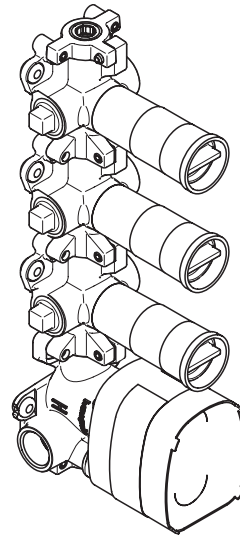

AXOR ShowerCollection
10750180

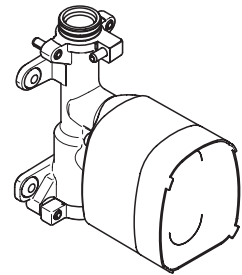

AXOR ShowerCollection
10650180

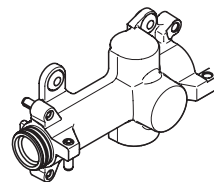

AXOR ShowerCollection
40877180

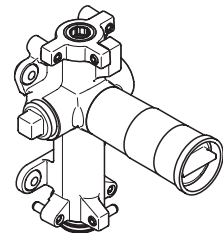

AXOR ShowerCollection
10971180

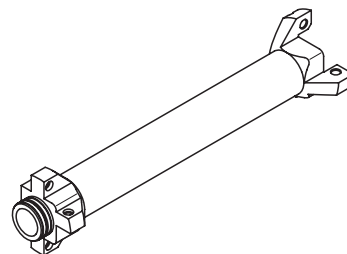

AXOR ShowerCollection
40878180

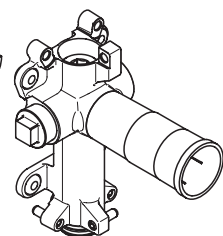

AXOR ShowerCollection
28486180

SICHERHEITSHINWEISE

- ⚠ Bei der Montage müssen zur Vermeidung von Quetsch- und Schnittverletzungen Handschuhe getragen werden.
- ⚠ Das Produkt darf nur zu Bade-, Hygiene- und Körperreinigungszwecken eingesetzt werden.
- ⚠ Kinder, sowie Erwachsene mit körperlichen, geistigen und/oder sensorischen Einschränkungen dürfen das Produkt nicht unbeaufsichtigt benutzen. Personen, die unter Alkohol- oder Drogeneinfluss stehen, dürfen das Produkt nicht benutzen.
- ⚠ Der Kontakt der Brausestrahlen mit empfindlichen Körperstellen (z. B. Augen) muss vermieden werden. Es muss ein ausreichender Abstand zwischen Brause und Körper eingehalten werden.
- ⚠ Große Druckunterschiede zwischen den Kalt- und Warmwasseranschlüssen müssen ausgeglichen werden.

ELEKTROANSCHLUSS

- ⚠ Der Elektroanschluss darf nur vom Elektrofachmann durchgeführt werden!
- ⚠ Stromversorgung 230V/N/PE/50Hz (Länge: 0,3 m) vorinstallieren.
- ⚠ Bei der Elektroinstallation sind die entsprechenden VDE-, Landes- und EVU-Vorschriften in der jeweils gültigen Fassung einzuhalten.

FEHLERSTROM-SCHUTZEINRICHTUNG

- ⚠ Die Absicherung muss über eine Fehlerstrom-Schutzeinrichtung (RCD/FI) mit einem Bemessungsdifferenzstrom ≤ 30 mA erfolgen.

ELEKTROINSTALLATEUR

- ⚠ Die Installations- und Prüfungsarbeiten sind von einer zugelassenen Elektrofachkraft, unter Berücksichtigung von VDE 0100 Teil 701 u. IEC 60364-7-701, auszuführen.

MONTAGEHINWEISE

- / Vor der Montage muss das Produkt auf Transportschäden untersucht werden. Nach dem Einbau werden keine Transport- oder Oberflächenschäden anerkannt.
- / Die Leitungen und die Armatur müssen nach den gültigen Normen montiert, gespült und geprüft werden.
- / Die in den Ländern jeweils gültigen Installationsrichtlinien sind einzuhalten.
- / Bei der Montage des Produktes durch qualifiziertes Fachpersonal ist darauf zu achten, dass die Befestigungsfläche im gesamten Bereich der Befestigung plan ist (keine vorstehenden Fugen oder Fliesenversatz), der Wandaufbau für eine Montage des Produktes geeignet ist und keine Schwachstellen aufweist.
- / Beim Bohren auf Strom- und Wasserleitungen achten!
- / Die Ablaufleistung muss ausreichend dimensioniert werden.

TECHNISCHE DATEN

Betriebsdruck:	max. 1 MPa
Empfohlener Betriebsdruck:	0,1 - 0,5 MPa
Prüfdruck:	1,6 MPa
	(1 MPa = 10 bar = 147 PSI)
Heißwassertemperatur:	max. 70°C
Empfohlene Heißwassertemperatur:	65°C
Anschlüsse:	G1/2 & G3/4
Durchflussleistung bei 0,3 MPa:	
10750180 (1 Verbraucher)	44 l/min
10750180 (2 Verbraucher)	55 l/min
10650180	25 l/min
10971180	55 l/min
28486180	50 l/min
Thermische Desinfektion:	max. 70°C / 4 min

Das Produkt ist ausschließlich für Trinkwasser konzipiert!
Eigensicher gegen Rückfließen

SYMBOLERKLÄRUNG

 Kein essigsäurehaltiges Silikon verwenden!

 MASSE (siehe Seite 31)

 MONTAGEBEISPIELE (siehe Seite 32)
Die Anordnung der Module den baulichen Gegebenheiten anpassen.

 SERVICETEILE (siehe Seite 57)

 ELEKTROINSTALLATEUR

 WARTUNG
Rückflussverhinderer müssen gemäß DIN EN 1717 regelmäßig in Übereinstimmung mit nationalen oder regionalen Bestimmungen auf ihre Funktion geprüft werden (mindestens einmal jährlich).

 Wasseranschluss DN20
Warmwasser

 Wasseranschluss DN20
Kaltwasser

 MITTE DUSCHWANNE

 WASSER ÖFFNEN / WASSER ABSTELLEN

 LEERROHR EN20

 SCHUTZHANDSCHUHE TRAGEN

 STROM AN / AUS

 MONTAGEABFOLGE

 ABGÄNGE ABSTOPFEN
Der nicht benötigte Abgang muss mit einem Blindstopfen abgedichtet werden.

 LEITUNGSGEFÄLLE
Wasserleitungen für Seitenbrausen mit Gefälle verlegen.

 PE POTENTIALAUSGLEICH

 N NULLEITER

 L LEITER

 FI FI-SCHUTZSCHALTER

 LICHTSCHALTER

 T NETZTEIL

 LEUCHTMITTEL

 STECKVERBINDUNGEN

 VERSTÄRKER FÜR LAUTSPRECHER

 WANDVERSTÄRKUNG NOTWENDIG

In diesem Bereich ist eine Wandverstärkung notwendig.

 PRÜFZEICHEN (siehe Seite 57)

CONSIGNES DE SÉCURITÉ

- ⚠ Lors du montage, porter des gants de protection pour éviter toute blessure par écrasement ou coupure.
- ⚠ Le produit ne doit servir qu'à se laver et à assurer l'hygiène corporelle.
- ⚠ Il est interdit aux enfants ainsi qu'aux adultes ayant des insuffisances physiques, psychiques et/ou motoriques d'utiliser la douche sans surveillance. De même, il est interdit à des personnes sous influence d'alcool ou de drogues d'utiliser la douche.
- ⚠ Éviter le contact du jet de la douchette avec les parties sensibles du corps (telles par ex. que les yeux). Veiller à respecter un écart suffisant entre la douchette et le corps
- ⚠ Il est conseillé d'équilibrer les pressions de l'eau chaude et froide.

RACCORD ÉLECTRIQUE

- ⚠ Seul un spécialiste est autorisé à réaliser le câblage!
- ⚠ Préinstaller l'alimentation électrique 230V/N/PE/50Hz (longueur : 0,3 m)
- ⚠ Respecter les consignes VDE, nationale et EVU correspondantes, dans leur version en vigueur.

DISPOSITIF DE PROTECTION À COURANT DE DÉFAUT

- ⚠ La protection par fusibles doit se faire avec un dispositif de protection par courant de défaut (RCD/FI) avec un courant différentiel résiduel de maximum 30 mA.

ÉLECTRICIEN INSTALLATEUR

- ⚠ Les travaux d'installation et de contrôle doivent être effectués par un électricien agréé en conformité avec les dispositions des normes VDE 0100 partie 701 et CEI 60364-7-701.

INSTRUCTIONS POUR LE MONTAGE

- / Avant son montage, s'assurer que le produit n'a subi aucun dommage pendant le transport. Après le montage, tout dommage de transport ou de surface ne pourra pas être reconnu.
- / Les conduites et la robinetterie doivent être montés, rincés et contrôlés selon les normes en vigueur.
- / Les directives d'installation en vigueur dans le pays concerné doivent être respectées.
- / Lors du montage de ce produit par du personnel qualifié, veiller à ce que la surface de fixation soit bien plane dans toute la zone de fixation (pas de dépassement de joints ou de déport de carreaux), à ce que le mur se prête au montage du produit et ne présente aucun point fragile.
- / Lors de travaux de perçage sur des conduites électriques et des conduites d'eau
- / Le débit du vidage doit être suffisamment dimensionné.

INFORMATIONS TECHNIQUES

Pression de service autorisée:	max. 1 MPa
Pression de service conseillée:	0,1 - 0,5 MPa
Pression maximum de contrôle:	1,6 MPa (1 MPa = 10 bar = 147 PSI)
Température d'eau chaude:	max. 70°C
Température recommandée:	65°C
Raccordement:	G1/2 & G3/4
Débit à 0,3 MPa:	
10750180 (1 Consommateur)	44 l/min
10750180 (2 Consommateur)	55 l/min
10650180	25 l/min
10971180	55 l/min
28486180	50 l/min
Désinfection thermique:	max. 70°C / 4 min

Le produit est exclusivement conçu pour de l'eau potable!
Avec dispositif anti-retour

DESCRIPTION DU SYMBOLE

	Ne pas utiliser de silicone contenant de l'acide acétique!		CENTRE CUVETTE DE DOUCHE		COMPENSATION DE POTENTIEL
	DIMENSIONS (voir pages 31)		OUVRIR L'EAU. / COUPER L'ARRIVÉE D'EAU		NEUTRE
	EXEMPLES DE MONTAGE (voir pages 32) Adapter la disposition des modules aux conditions locales		TUBE VIDE EN20		CONDUCTEUR
	PIÈCES DÉTACHÉES (voir pages 57)		PROTECTION OBLIGATOIRE DES MAINS		DISJONCTEUR FI
	ÉLECTRICIEN INSTALLATEUR		COURANT MARCHÉ / ARRÊT		INTERRUPTEUR D'ÉCLAIRAGE
	ENTRETIEN Les clapets anti-retour doivent être examinés régulièrement conformément à la norme EN 1717 ou conformément aux dispositions nationales ou régionales quant à leur fonction (au moins une fois par an).		ORDRE DU MONTAGE		TRANSFO
	Raccord d'eau DN20 Eau chaude		OBTURER LES SORTIES La sortie non utilisée doit être condamnée avec un bouchon laiton.		MOYEN D'ÉCLAIRAGE
	Raccord d'eau DN20 Eau froide		DÉNIVELLATION DES CONDUITES La tuyauterie des douchettes latérales à installer avec une pente.		CONNECTEUR
					AMPLIFICATEUR POUR HAUT-PARLEUR
					RENFORCEMENT DE LA PAROI NÉCESSAIRE Le mur n'a pas besoin d'être renforcé à cet endroit
					CLASSIFICATION ACOUSTIQUE ET DÉBIT (voir pages 57)

SAFETY NOTES

- ⚠ Gloves should be worn during installation to prevent crushing and cutting injuries.
- ⚠ The product may only be used for bathing, hygienic and body cleaning purposes.
- ⚠ Children as well as adults with physical, mental and/or sensoric impairments must not use this product without proper supervision. Persons under the influence of alcohol or drugs are prohibited from using this product.
- ⚠ Do not allow the streams of the shower touch sensitive body parts (such as your eyes). An adequate distance must be kept between the shower and you.
- ⚠ The hot and cold supplies must be of equal pressures.

⚠ ELECTRICAL CONNECTION

- ⚠ The electrical connection may only be carried out by an electrician!
- ⚠ Preinstall electrical power 230 V/N/PE/50 Hz (length: 0.3 m)
- ⚠ The current version of the applicable regulations from VDE, local authorities and utility companies must be observed for electric installation work.

RESIDUAL CURRENT PROTECTION SYSTEM

- ⚠ The system must be protected via a leakage current protective device (RCD/FI) with a measurement difference current of ≤ 30 mA.

⚠ ELECTRICIAN

- ⚠ The installation and testing work must be performed by a skilled electrician in observance of VDE 0100 part 701 and IEC 60364-7-701.

INSTALLATION INSTRUCTIONS





- / Prior to installation, inspect the product for transport damages. After it has been installed, no transport or surface damage will be honoured.
- / The pipes and the fixture must be installed, flushed and tested as per the applicable standards.
- / The plumbing codes applicable in the respective countries must be observed.
- / During installation of the product by qualified trained personnel, make sure that the entire fastening surface is even and smooth (no protruding seams or tile offset), that the finish of the wall is suitable to apply the product and has no weak points.
- / Observe all current and water lines when drilling!
- / The performance of the waste must be of sufficient size.

TECHNICAL DATA

Operating pressure:	max. 1 MPa
Recommended operating pressure:	0,1 - 0,5 MPa
Test pressure:	1,6 MPa (1 MPa = 10 bar = 147 PSI)
Hot water temperature:	max. 70°C
Recommended hot water temp.:	65°C
Connections:	G1/2 & G3/4
Rate of flow by 0,3 MPa:	
10750180 (1 Consumer)	44 l/min
10750180 (2 Consumer)	55 l/min
10650180	25 l/min
10971180	55 l/min
28486180	50 l/min
Thermal disinfection:	max. 70°C / 4 min

The product is exclusively designed for drinking water!
Safety against backflow

SYMBOL DESCRIPTION

 Do not use silicone containing acetic acid!	 CENTER SHOWER TUB	 POTENTIAL EQUALISATION
 DIMENSIONS (see page 31)	 TURN ON WATER / TURN OFF WATER	 NEUTRAL CONDUCTOR
 INSTALLATION EXAMPLE (see page 32) Adjust the module arrangement to the local conditions	 EMPTY PIPE EN20	 CONDUCTOR
 SPARE PARTS (see page 57)	 SAFETY GLOVES MUST BE WORN	 FI PROTECTIVE SWITCH
 ELECTRICIAN	 ELECTRICITY ON / OFF	 LIGHT SWITCH
 MAINTENANCE The check valves must be checked regularly according to DIN EN 1717 in accordance with national or regional regulations (at least once a year).	 INSTALLATION SEQUENCE	 TRANSFORMER
 Water connection DN20	 PLUG OUTLETS Plug the unused outlet.	 ILLUMINANT
 Warm water	 PIPE DECLINE Install water pipes for body showers with a gradient.	 CONNECTORS
 Cold water		 AMPLIFIER FOR SPEAKER
		 AREA FOR REQUIRED WALL REINFORCEMENT The wall must be reinforced in this area.
		 TEST CERTIFICATE (see page 57)

INDICAZIONI SULLA SICUREZZA

- ⚠ Durante il montaggio, per evitare ferite da schiacciamento e da taglio bisogna indossare guanti protettivi.
- ⚠ Il prodotto deve essere utilizzato esclusivamente per fare il bagno e per l'igiene del corpo.
- ⚠ I bambini e gli adulti affetti da menomazioni fisiche, psichiche e/o sensoriali devono utilizzare il sistema doccia solo sotto sorveglianza. Il prodotto non deve essere utilizzato da persone sotto l'effetto di droghe o alcolici.
- ⚠ Bisogna evitare il contatto fra il getto della doccia e parti del corpo delicate (ad es. gli occhi). Fra il soffione ed il corpo va mantenuta una distanza sufficiente.
- ⚠ Attenzione! Compensare le differenze di pressione tra i collegamenti dell'acqua fredda e dell'acqua calda.

⚠ ALLACCIAMENTO ELETTRICO

- ⚠ Il cablaggio deve essere eseguito esclusivamente da un installatore specializzato
- ⚠ Preinstallare l'alimentazione elettrica di 230V/N/PE/50Hz (lunghezza: 0,3 m).
- ⚠ Per l'installazione elettrica vanno rispettate le corrispondenti prescrizioni VDE, del Paese e EVU nella rispettiva versione valida.

CIRCUITO DI SICUREZZA PER CORRENTI DI GUASTO

- ⚠ Per protezione bisogna installare un circuito di sicurezza per correnti di guasto (RCD/FI) con una corrente differenziale nominale di ≤ 30 mA.

⚠ INSTALLATORE ELETTRICISTA

- ⚠ I lavori di installazione e di controllo vanno eseguiti da un elettricista specializzato autorizzato, in considerazione della normativa VDE 0100 Parte 701 e IEC 60364-7-701.

ISTRUZIONI PER IL MONTAGGIO

- / Prima del montaggio è necessario controllare che non ci siano stati danni durante il trasporto. Una volta eseguito il montaggio, non verranno riconosciuti eventuali danni di trasporto o delle superfici.
- / Montare, lavare e controllare tubature e rubinetteria rispettando le norme correnti.
- / Vanno rispettate le direttive di installazione nazionali vigenti nel rispettivo paese.
- / Per il montaggio del prodotto da personale specializzato qualificato bisogna fare attenzione, che la superficie di fissaggio, in tutto il campo di fissaggio, sia piana (nessuna giunzione sporgente o sfalsamento di piastrella), la costruzione della parete sia adatta al montaggio del prodotto e che non presenti alcun punto debole.
- / Nel praticare i fori attenzione a non danneggiare linee elettriche ed idriche!
- / Lo scarico deve essere sufficientemente dimensionato.

DATI TECNICI

Pressione d'uso:	max. 1 MPa
Pressione d'uso consigliata:	0,1 - 0,5 MPa
Pressione di prova:	1,6 MPa (1 MPa = 10 bar = 147 PSI)
Temperatura dell'acqua calda:	max. 70°C
Temp. dell'acqua calda consigliata:	65°C
Raccordi:	G1/2 & G3/4
Potenza di erogazione a 0,3 MPa:	
10750180 (1 Utenza)	44 l/min
10750180 (2 Utenza)	55 l/min
10650180	25 l/min
10971180	55 l/min
28486180	50 l/min
Disinfezione termica:	max. 70°C / 4 min

Il prodotto è concepito esclusivamente per acqua potabile!
Sicurezza antiriflusso

DESCRIZIONE SIMBOLO

	Non utilizzare silicone contenente acido acetico!		CENTRO PIATTO DOCCIA		COMPENSAZIONE DI POTENZIALE
	INGOMBRI (vedi pagg. 31)		APRIRE L' ACQUA / CHIUDERE L' ACQUA		CONDUTTORE NEUTRO
	ESEMPIO DI INSTALLAZIONE (vedi pagg. 32) Adattare la disposizione dei moduli alle circostanze architettoniche.		TUBO VUOTO EN20		CONDUTTORE
	PARTI DI RICAMBIO (vedi pagg. 57)		INDOSSARE GUANTI DI PROTEZIONE		INTERRUTTORE DI SICUREZZA PER CORRENTI DI GUASTO
	INSTALLATORE ELETTRICISTA		CORRENTE ON / OFF		INTERRUTTORE LUCE
	MANUTENZIONE La valvola di non ritorno deve essere controllata regolarmente come da DIN EN 1717, secondo le normative nazionali e regionali (almeno una volta all'anno).		SEQUENZA DI MONTAGGIO		TRASFORMATORE
	TAPPARE LE USCITE Chiudere con un tappo l'uscita non utilizzata.		PENDENZA TUBI Posizionare i tubi alle doccette laterali con una leggera pendenza.		LAMPADA
	Allacciamento acqua DN20 Acqua calda		Allacciamento acqua DN20 Acqua fredda		COLLEGAMENTI A SPINA
			AMPLIFICATORE PER ALTOPARLANTE		CAMPO RINFORZO NECESSARIO DELLA PARETE In questa zona è necessario un rinforzo della parete.
			SEGNO DI VERIFICA (vedi pagg. 57)		

INDICACIONES DE SEGURIDAD

- ⚠ Durante el montaje deben utilizarse guantes para evitar heridas por aplastamiento o corte.
- ⚠ El producto solo debe ser utilizado para fines de baño, higiene y limpieza corporal.
- ⚠ Niños, así como adultos con limitaciones corporales, mentales y/o sensoriales no deben utilizar el sistema de duchas sin vigilancia. Personas que se encuentran bajo el efecto de alcohol o drogas, no deben utilizar el sistema de duchas.
- ⚠ Debe evitarse el contacto del chorro del pulverizador con partes sensibles del cuerpo (por ej. ojos). Debe mantenerse una distancia suficiente entre pulverizador y cuerpo.
- ⚠ Grandes diferencias de presión en servicio entre agua fría y agua caliente deben equilibrarse.

CONEXIÓN ELÉCTRICA

- ⚠ ¡Solo un especialista está autorizado para llevar a cabo los trabajos de cableado!
- ⚠ Instalar previamente el suministro eléctrico 230V/N/PE/50Hz (longitud: 0,3 m).
- ⚠ Para la instalación eléctrica deben respetarse las disposiciones correspondientes VDE, de cada país, y EVU en su versión vigente.

DISPOSITIVO DIFERENCIAL RESIDUAL

- ⚠ La conexión debe establecerse a través de un dispositivo de protección de corriente residual (RCD/FI) con un interruptor diferencial de corriente ≤ 30 mA.

INSTALADOR ELÉCTRICO

- ⚠ Las tareas de instalación y prueba únicamente pueden ser realizadas por personal electricista cualificado, respetando las reglamentaciones de las normas VDE 0100, parte 701, e IEC 60364-7-701.

INDICACIONES PARA EL MONTAJE

- / Antes del montaje se debe examinarse el producto contra daños de transporte. Después de la instalación no se reconoce ningún daño de transporte o de superficie.
- / Los conductos y la grifería deben montarse, lavarse y comprobarse según las normas vigentes.
- / Es obligatorio el cumplimiento de las directrices de instalación vigentes en el país respectivo.
- / Durante el montaje del producto, mediante personal especializado, se debe asegurar de que la superficie de sujeción en todo el área de la fijación sea plana (sin fugas o azulejos que sobresalgan), que la estructura del muro sea adecuada para el montaje del producto y que no presente puntos débiles.
- / ¡Prestar especial atención al taladrar cerca de conductos eléctricos o de agua!
- / La tubería de desagüe ha de tener una dimensión suficiente.

DATOS TÉCNICOS

Presión en servicio:	max. 1 MPa
Presión recomendada en servicio:	0,1 - 0,5 MPa
Presión de prueba:	1,6 MPa (1 MPa = 10 bar = 147 PSI)
Temperatura del agua caliente:	max. 70°C
Temp. recomendada del agua caliente:	65°C
Racores excéntricos:	G1/2 & G3/4
Caudal a 0,3 MPa:	
10750180 (1 Consumidor)	44 l/min
10750180 (2 Consumidor)	55 l/min
10650180	25 l/min
10971180	55 l/min
28486180	50 l/min
Desinfección térmica:	max. 70°C / 4 min

El producto ha sido concebido exclusivamente para agua potable.
Seguro contra el retorno

DESCRIPCIÓN DE SÍMBOLOS

 No utilizar silicona que contiene ácido acético!	 CENTRO LA PLATO DE DUCHA	 PROTECCIÓN EQUIPOTENCIAL
 DIMENSIONES (ver página 31)	 ABRIR EL AGUA / CERRAR EL AGUA	 CONDUCTOR NEUTRO
 EJEMPLOS DE MONTAJE (ver página 32) Adaptar la disposición de los módulos a las condiciones constructivas.	 TUBO VACÍO EN20	 CONDUCTOR
 REPUESTOS (ver página 57)	 PROTECCIÓN OBLIGATORIA DE LA VISTA	 CONMUTADOR DE PROTECCIÓN FI
 INSTALADOR ELÉCTRICO	 CORRIENTE ON / OFF	 INTERRUPTOR DE LUZ
 MANTENIMIENTO Las válvulas anti-retorno tienen que ser controladas regularmente según la norma DIN EN 1717, en acuerdo con las regulaciones nacionales o regionales (una vez al año, por lo menos).	 SECUENCIA DE MONTAJE	 TRANSFORMADOR
	 LLENAR SALIDAS La salida que no se utiliza debe ser tapada.	 LUCES
	 PENDIENTE DE LA CONDUCCIÓN Tubería hacia las duchas laterales con pendiente.	 UNIONES INSERTABLES
 Conexión de agua DN20 Agua caliente		 AMPLIFICADOR PARA ALTAVOCES
 Conexión de agua DN20 Agua fría		 ÁREA REFUERZO NECESARIO DE LA PARED En este sector es necesario un refuerzo del muro.
		 MARCA DE VERIFICACIÓN (ver página 57)

VEILIGHEIDSINSTRUCTIES

- ⚠ Bij de montage moeten ter voorkoming van knel- en snijwonden handschoenen worden gedragen.
- ⚠ Het product mag alleen voor het wassen, hygiënische doeleinden en voor de lichaamreiniging worden gebruikt.
- ⚠ Kinderen en volwassenen met lichamelijke, geestelijke en/of sensorische beperkingen mogen het douchesysteem niet zonder toezicht gebruiken. Personen onder invloed van alcohol of drugs mogen het douchesysteem niet gebruiken.
- ⚠ Het contact van de douchestraal met gevoelige lichaamsdelen (bijv. ogen) moet worden voorkomen. Er moet voldoende afstand tussen douche en lichaam aangehouden worden.
- ⚠ Grote drukverschillen tussen de koud- en warmwatertoevoer dienen vermeden te worden.

ELEKTRISCHE AANSLUITING

- ⚠ De elektrische aansluiting mag alleen door een vakman worden uitgevoerd!
- ⚠ Stroomvoorziening 230V/N/PE/50Hz (lengte: 0,3 m) vooraf installeren.
- ⚠ Bij de elektrische installatie moeten de overeenkomstige VDE-, nationale en EVU-voorschriften in de geldige versie in acht genomen worden.

AARDLEKSCHELAAR

- ⚠ Deze moet middels een 2-polige FI-schakelaar met 30mA afgezekerd worden.

ELECTRO-INSTALLATEUR

- ⚠ De installatie- en controlewerkzaamheden moeten uitgevoerd worden door een geautoriseerde electricien die rekening houdt met de normen VDE 0100 Deel 701 en IEC 60364-7-701.

MONTAGE-INSTRUCTIES

- / Vóór de montage moet het product gecontroleerd worden op transportschade. Na de inbouw wordt geen transport- of oppervlakteschade meer aanvaard.
- / De leidingen en armaturen moeten gemonteerd, gespoeld en gecontroleerd worden volgens de geldige normen.
- / De in de overeenkomstige landen geldende installatierichtlijnen moeten nageleefd worden.
- / Bij de montage van het product door gekwalificeerd vakpersoneel moet erop gelet worden dat het montagevlak in het volledige bereik van de bevestiging vlak is (geen uitstekende voegen of verspringende tegels), dat de wand geschikt is voor de montage van het product en geen zwakke plaatsen vertoont.
- / Bij het boren in stroom- en waterleidingen
- / De afvoercapaciteit moet voldoende gedimensioneerd worden.

TECHNISCHE GEGEVENS

Werkdruk: max.	max. 1 MPa
Aanbevolen werkdruk:	0,1 - 0,5 MPa
Getest bij:	1,6 MPa (1 MPa = 10 bar = 147 PSI)
Temperatuur warm water:	max. 70°C
Aanbevolen warm water temp.:	65°C
Aansluitingen:	G1/2 & G3/4
Doorvoercapaciteit bij 0,3 MPa:	
10750180 (1 Verbruiker)	44 l/min
10750180 (2 Verbruiker)	55 l/min
10650180	25 l/min
10971180	55 l/min
28486180	50 l/min
Thermische desinfectie:	max. 70°C/4 min

Het product is uitsluitend ontworpen voor drinkwater!
Beveiligd tegen terugstromen

SYMBOOLBESCHRIJVING

 Gebruik geen zuurhoudende siliconen!

 MATEN (zie blz. 31)

 MONTAGEVOORBEELDEN (zie blz. 32)

De rangschikking van de modules moet aan de bouwtechnische omstandigheden worden aangepast

 SERVICE ONDERDELEN (zie blz. 57)

 ELECTRO-INSTALLATEUR

 ONDERHOUD

Keerleppen moeten volgens DIN EN 1717 regelmatig en volgens plaatselijk geldende eisen op het functioneren gecontroleerd worden. (Tenminste een keer per jaar)

 Wateraansluiting DN20
Warm water

 Wateraansluiting DN20
Koud water

 MIDDEN DOUCHEBAK

 HOOFDKRAAN OPENEN / WATER AFSLUITEN

 LEGE BUIS EN20

 VEILIGHEIDSHANDSCHOENEN VERPLICHT

 STROOM AAN / UIT

MONTAGEVOLGORDE

 AFTAPPUNT AFSLUITEN

De niet benodigde uitgang moet met een blindstop worden afgedicht.

 LEIDINGSAFLOOP
Waterleidingen voor zijdouches aflopend plaatsen.

 POTENTIAALVEREFFENING

 NULGELEIDER

 GELEIDER

 FI-VEILIGHEIDSSCHAKELAAR

 LICHTSCHAKELAAR

 TRAF0

 VERLICHTINGSMIDDEL

 STEEKVERBINDING

 VERSTERKER VOOR LUIDSPREKERS

 WANDVERSTERKING NOODZAKELIJK VOOR MONTAGE

In dit bereik is een wandversterking noodzakelijk.

 KEURMERK (zie blz. 57)

MONTAGE (zie blz. 52) 

SIKKERHEDSANVISNINGER

- ⚠ Ved monteringen skal der bruges handsker for at undgå kvæstelser og snitsår.
- ⚠ Produktet må kun bruges til bade-, hygiejne og kropsurengøringsformål.
- ⚠ Børn som også voksne med fysiske, mentale og/eller sensoriske begrænsninger må ikke bruge brusersystemet uden opsyn. Personer som er under indflydelse af alkohol eller narkotika må ikke bruge brusersystemet.
- ⚠ Bruserstrålens kontakt med sensitive områder (f.eks. øjne) skal undgås. Der skal være en tilstrækkelig afstand mellem bruseren og kroppen.
- ⚠ Større trykforskelle mellem koldt og varmt vand bør udjævnes.

EL-TILSLUTNING

- ⚠ Ledningsarbejde må kun foretages af en fagmand!
- ⚠ Strømforsyning 230V/N/PE/50Hz (længde: 0,3 m) allerede installeret.
- ⚠ Ved el-installeringen skal der tages hensyn til branchens forskrifter og de tilsvarende gældende nationale love og forskrifter.

FJELSTRØMSBESKYTTELSE

- ⚠ Sikringen skal køre over en fejlstrømssikring (HFI) med en fejlstrømsdifference ≤ 30 mA.

EL-INSTALLATØR

- ⚠ Installeringen og afprøvningen skal gennemføres af en godkendt el-installatør iht. VDE 0100 part 701 og IEC 60364-7-701.

MONTERINGSANVISNINGER







- / Før monteringen skal produktet kontrolleres for transportskader. Efter monteringen godkendes transportskader eller skader på overfladen ikke længere.
- / Ledningerne og armaturerne skal monteres, skylles og kontrolleres iht. de gældende standarder.
- / Installationsbestemmelserne, der gælder i det enkelte land, skal overholdes.
- / Ved montering af produktet igennem kvalificerede fagfolk skal der holdes øje med, at fastgørelsesoverfladen er plan i alle områder hvor produktet monteres (ingen fremragende fuger eller fliseforskydninger), at væggene er velegnet til monteringen af produktet og ikke har svare områder.
- / Pas på strøm- og vandledninger ved boring!
- / Afløbet skal være i en tilstrækkelig størrelse.

TEKNISKE DATA

Driftstryk:	max. 1 MPa
Anbefalet driftstryk:	0,1 - 0,5 MPa
Prøvetryk:	1,6 MPa
	(1 MPa = 10 bar = 147 PSI)
Varmtvandstemperatur:	max. 70°C
Anbefalet varmtvandstemperatur:	65°C
Tilslutninger:	G1/2 & G3/4
Gennemstrømningsydelse ved 0,3 MPa:	
10750180 (1 Forbruger)	44 l/min
10750180 (2 Forbruger)	55 l/min
10650180	25 l/min
10971180	55 l/min
28486180	50 l/min
Termisk desinfektion:	max. 70°C / 4 min

Produktet er udelukkende beregnet til drikkevand!
Med indbygget kontraventil

SYMBOLBESKRIVELSE

	Der må ikke benyttes eddikesyreholdig silikone!		MIDT BRUSEKAR		POTENTIALUDLIGNING
	MÅLENE (se s. 31)		TÆND FOR VANDET / LUK FOR VANDET		NULLEDER
	MONTERINGSEKSEMPLER (se s. 32)		TOMT RØR EB20		LEDER
	Tilpasse modulernes arrangement til bygnings-situationen.		BESKYTTELSESHANDSKER PÅ-BUDT		FI-BESKYTTELSESKONTAKT
	RESERVEDELE (se s. 57)		STRØM TIL / FRA		LYSKONTAKT
	EL-INSTALLATØR		MONTERINGSRÆKKEFØLGE		TRANSFORMER
	SERVICE		PROPPE AFLØB		LYSKILDE
	Ifølge DIN EN 1717 skal gennemstrømnings-begrænsere i overensstemmelse med nationale regler afprøves regelmæssigt (mindst en gang om året).		Afgangen, der ikke benyttes, skal afpropes.		STIKFORBINDELSER
			LEDNINGSFALD		FORSTÆRKER TIL HØJTALERE
			Vandledningerne til sidebruserne med fald.		OMRÅDE NØDVENDIGVÆG-FORSTÆRKNING
	Vandtilslutning DN20				I dette område er en forstærkning af væggen nødvendig.
	Varmt vand				GODKENDELSE (se s. 57)
	Vandtilslutning DN20				
	Koldt vand				

AVISOS DE SEGURANÇA

- ⚠ Durante a montagem devem ser utilizadas luvas de protecção, de modo a evitar ferimentos resultantes de entalamentos e de cortes.
- ⚠ O produto só pode ser utilizado para fins de higiene pessoal.
- ⚠ Crianças e adultos com deficiências motoras, mentais e/ou sensoriais não podem utilizar o sistema de duche sem monitorização. Pessoas que estejam sob a influência de álcool ou drogas não podem utilizar o sistema de duche.
- ⚠ Deve-se evitar o contacto dos jactos de água com partes do corpo sensíveis (p. ex. olhos). É necessário manter uma distância suficiente entre o chuveiro e o corpo.
- ⚠ Grandes diferenças entre as pressões das águas quente e fria devem ser compensadas.

⚠ LIGAÇÃO ELÉCTRICA

- ⚠ A instalação eléctrica deve ser efectuada apenas por um electricista qualificado!
- ⚠ Pré-instalar a alimentação eléctrica 230V/N/PE/50Hz (comprimento: 0,3 m).
- ⚠ Na instalação eléctrica deve ser cumprida a versão válida das prescrições VDE, nacionais e EVU.

DISPOSITIVO DE PROTECÇÃO PARA CORRENTE DE FUGA

- ⚠ A ligação deve estar protegida por um diferencial magneto-térmico bipolar (RRCB) com uma corrente residual ≤ 30 mA.

⚠ ELECTRICISTA DE CONSTRUÇÃO CIVIL

- ⚠ Os trabalhos de instalação e de controlo devem ser efectuados por um técnico electricista devidamente autorizado e especializado, tendo em consideração as normas VDE 0100 Parte 701 e IEC 60364-7-701.

AVISOS DE MONTAGEM

- / Antes da montagem deve-se controlar o produto relativamente a danos de transporte. Após a montagem não são aceites quaisquer danos de transporte ou de superfície.
- / As tubagens e a torneira têm que ser montadas, enxaguadas e verificadas de acordo com as normas em vigor.
- / A prescrições de instalação válidas nos respetivos países devem ser respeitadas.
- / Durante a montagem efectuada por técnicos qualificados deve ter-se em atenção que a superfície de fixação seja plana em toda a sua extensão (sem juntas ou ladrilhos salientes), que a estrutura da parede seja adequada para a montagem do produto e que não apresente pontos fracos.
- / Ter atenção a instalações eléctricas e de água durante os trabalhos de perfuração!
- / A capacidade de escoamento deve ser devidamente dimensionada.

DADOS TÉCNICOS

Pressão de funcionamento:	max. 1 MPa
Pressão de func. recomendada:	0,1 - 0,5 MPa
Pressão testada:	1,6 MPa (1 MPa = 10 bar = 147 PSI)
Temperatura da água quente:	max. 70°C
Temp. água quente recomendada:	65°C
Ligações:	G1/2 & G3/4
Caudal a 0,3 MPa:	
10750180 (1 Consumidor)	44 l/min
10750180 (2 Consumidor)	55 l/min
10650180	25 l/min
10971180	55 l/min
28486180	50 l/min
Desinfecção térmica:	max. 70°C / 4 min

Este produto foi única e exclusivamente concebido para água potável!
Função anti-retorno e anti-vácuo

DESCRIÇÃO DO SÍMBOLO

 Não utilizar silicone que contenha ácido acético!	 MEIO DA BASE DE DUCHE	 LIGAÇÃO EQUIPOTENCIAL
 MEDIDAS (ver página 31)	 ABRIR A ÁGUA / CORTAR A ÁGUA	 CONDUTOR NEUTRO
 EXEMPLOS DE MONTAGEM (ver página 32) Adaptar a disposição dos módulos às características locais.	 TUBO VAZIO EN20	 CONDUTOR
 PEÇAS DE SUBSTITUIÇÃO (ver página 57)	 PROTECÇÃO OBRIGATÓRIA DAS MÃOS	 INTERRUPTOR FI
 ELECTRICISTA DE CONSTRUÇÃO CIVIL	 ELECTRICIDADE LIGADA/DESLIGADA	 INTERRUPTOR DE LUZ
 MANUTENÇÃO As válvulas anti-retorno devem ser verificadas regularmente de acordo com a DIN EN 1717 segundo os regulamentos nacionais ou regionais (pelo menos uma vez por ano).	 SEQUÊNCIA DE MONTAGEM	 TRANSFORMADOR
	 TAPAR SAÍDAS Tamponar a saída não utilizada.	 LÂMPADA
	 INCLINAÇÃO DA TUBAGEM Instalar os tubos para os chuveiros laterais com ligeira inclinação.	 TOMADAS DE LIGAÇÃO
 Ligação da água DN20		 AMPLIFICADOR PARA ALTI-FALANTE
 Ligação da água DN20		 ÁREA REFORÇADA NECESSÁRIA DA PAREDE Nesta zona é necessário um reforço na parede.
 Água fria		 MARCA DE CONTROLO (ver página 57)

WSKAZÓWKI BEZPIECZEŃSTWA

- ⚠ Aby uniknąć zranień na skutek zgniecia lub przecięcia, podczas montażu należy nosić rękawice ochronne.
- ⚠ Produkt może być używany tylko do kąpieli, higieny i czyszczenia ciała.
- ⚠ Zarówno dzieci, jak i dorośli z fizycznymi, psychicznymi i/lub sensorycznymi ograniczeniami nie mogą korzystać z prysznica bez opieki. Osoby znajdujące się pod wpływem alkoholu lub narkotyków nie mogą korzystać z prysznica.
- ⚠ Należy unikać kontaktu strumienia wyływającego z głowicy z wrażliwymi częściami ciała (np. oczami). Należy zachowywać odpowiednią odległość pomiędzy głowicą a ciałem.
- ⚠ Znaczne różnice ciśnień na dopływach ciepłej i zimnej wody muszą zostać wyrównane.

⚠ PRZYŁĄCZE ELEKTRYCZNE

- ⚠ Podłączenie elementów elektrycznych może być przeprowadzone jedynie przez fachowca elektryka!
- ⚠ Zasilanie prądem 230V/N/PE/50Hz (długość: 0,3 m) zainstalować wstępnie.
- ⚠ Przy instalacji elektrycznej należy przestrzegać odpowiednich przepisów krajowych i europejskich w obowiązującej wersji.

URZĄDZENIE OCHRONNE PRĄDOWE

- ⚠ Zabezpieczenie instalacji musi mieć miejsce przy użyciu zabezpieczenia różnicowego (RCD/FI) z różnicą pomiarów wynoszącą ≤ 30 mA.

⚠ ELEKTRYK INSTALATOR

- ⚠ Prace instalacyjne i kontrolne mogą być przeprowadzane jedynie przez wykwalifikowanego elektryka, przestrzegając przepisów z VDE 0100 część 701 i IEC 60364-7-701.

WSKAZÓWKI MONTAŻOWE









- / Przed montażem należy skontrolować produkt pod kątem szkód transportowych. Po montażu nie widać żadnych szkód transportowych ani szkód na powierzchni.
- / Przewody i armatura muszą być montowane, płukane i kontrolowane według obowiązujących norm.
- / Należy przestrzegać wytycznych instalacyjnych obowiązujących w danym kraju.
- / Montaż produktu musi być wykonany przez wykwalifikowanego fachowca. Powierzchnia w miejscu montażu musi być równa (bez uskoków wzgl. wzajemnie przesuniętych płytek). Ściana w miejscu montażu musi być stabilna. Dołożone w komplecie śruby i kołki rozporowe są przeznaczone do betonu.
- / Podczas wiercenia uważać na instalacje elektryczne i wodne!
- / Odpływ musi mieć wystarczającą wydajność.



DANE TECHNICZNE

Ciśnienie robocze:	maks. 1 MPa
Zalecane ciśnienie robocze:	0,1 - 0,5 MPa
Ciśnienie próbne:	1,6 MPa
	(1 MPa = 10 bary = 147 PSI)
Temperatura wody gorącej:	maks. 70°C
Zalecana temperatura wody gorącej:	65°C
Przyłącza:	G1/2 & G3/4
Wydajność przepływu przy 0,3 MPa:	
10750180 (1 Odbiornik)	44 l/min
10750180 (2 Odbiornik)	55 l/min
10650180	25 l/min
10971180	55 l/min
28486180	50 l/min
Dezynfekcja termiczna:	maks. 70°C / 4 min

Produkt przeznaczony wyłącznie do wody pitnej!
Zabezpieczony przed przepływem zwrotnym

OPIS SYMBOLU

-  Nie stosować silikonów zawierających kwas octowy!
-  WYMIARY (patrz strona 31)
-  PRZYKŁADY MONTAŻOWE (patrz strona 32)
Dopasować rozmieszczenie modułów do warunków budowy.
-  CZĘŚCI SERWISOWE (patrz strona 57)
-  ELEKTRYK INSTALATOR
-  KONSERWACJA
Zgodnie z normą DIN EN 1717, krajowymi i miejscowymi przepisami, działanie zabezpieczeń przed przepływem zwrotnym musi być kontrolowane (przynajmniej raz w roku).
-  Podłączenie wody DN20
Ciepła woda
-  Podłączenie wody DN20
Zimna woda

-  ŚRODEK BRODZIKA
-  OTWORZYĆ WODĘ / ZAKRĘCIĆ WODĘ
-  RURA OSŁONOWA DO PROWADZENIA PRZEWODÓW EN20
-  NOSIĆ RĘKAWICE OCHRONNE
-  WŁ. / WYŁ. PRĄD
-  PRZEBIEG MONTAŻU
-  ODBLOKOWANIE ODPROWADZEŃ
Niewykorzystany wylot należy zakorkować dołożonym w dostawie korkiem.
-  SPADEK PRZEWODÓW
Przewody doprowadzające do pryszniców bocznych położyć z nachyleniem.

-  PE WYRÓWNIANIE POTENCJAŁU
-  N PRZEWÓD ZEROWY
-  L PRZEWÓD
-  FI WYŁĄCZNIK RÓŻNICOWOPRĄDOWY FI
-  WYŁĄCZNIK OŚWIETLENIOWY
-  TRANSFORMATOR
-  ŹRÓDŁO ŚWIATŁA
-  POŁĄCZENIA WTYKOWE
-  WZMACNIACZ DO GŁOŚNIKA
-  NIEZBĘDNE WZMOCNIENIE ŚCIAN
W tym obszarze konieczne jest wzmocnienie ściany.
-  ZNAK JAKOŚCI (patrz strona 57)

BEZPEČNOSTNÍ POKYNY

- ⚠ Pro zabránění řezným zraněním a pohmožděninám je nutné při montáži nosit rukavice.
- ⚠ Produkt smí být používán pouze ke koupání a za účelem tělesné hygieny.
- ⚠ Děti a dospělá osoba s tělesným, duševním a/nebo smyslovým postižením nesmí produkt používat bez dozoru. Osoby pod vlivem alkoholu nebo drog nesmí produkt používat.
- ⚠ Je nutné zabránit kontaktu vodních paprsků sprchy s měkkými částmi těla (např. očima). Je nutné dodržovat dostatečný odstup mezi sprchou a tělem.
- ⚠ Je nutné vyrovnat velké rozdíly tlaku mezi přípoji studené a teplé vody.

ELEKTRICKÉ PŘIPOJENÍ

- ⚠ Elektroinstalace smí být provedena jen kvalifikovaným elektrikářem!
- ⚠ Předinstalujte elektrické napájení 230V/N/PE/50Hz délka: 0,3 m)
- ⚠ Při elektroinstalaci musíte dodržet příslušné předpisy VDE a místní předpisy energetických podniků, vždy v platném znění.

OCHRANNÉ ZAŘÍZENÍ CHYBOVÉHO PROUDU

- ⚠ Přívod musí být chráněn proudovým chráničem pro chybový proud (RCD/FI) s mírným rozdílovým proudem ≤ 30 mA.

ELEKTROINSTALATÉR

- ⚠ Instalační práce a přezkoušení musí být provedeno autorizovaným elektrotechnickým odborníkem za zohlednění směrnice VDE 0100, část 701 a IEC 60364-7-701.

POKYNY K MONTÁŽI

- / Před montáží je třeba produkt zkontrolovat, zda nebyl při transportu poškozen. Po zabudování nebudou uznány žádné škody způsobené transportem nebo poškození povrchu.
- / Vedení a armatura musí být namontovány, propláchnuty a otestovány podle platných norem.
- / Je třeba dodržovat montážní pravidla platné v dané zemi.
- / Při montáži produktu kvalifikovanou osobou je třeba dbát na to, aby byla upevňovací plocha v celé oblasti upevnění rovná (žádné vyčnívající spáry nebo zapuštění obkladů), aby struktura stěny byla vhodná pro montáž produktu a neměla žádná slabá místa.
- / Při vrtání dejte pozor na elektrická vedení a vodovodní potrubí!
- / Propustnost odpadu musí být dostatečně dimenzována.

TECHNICKÉ ÚDAJE

Provozní tlak:	max. 1 MPa
Doporučený provozní tlak:	0,1 - 0,5 MPa
Zkušební tlak:	1,6 MPa (1 MPa = 10 bar = 147 PSI)
Teplota horké vody:	max. 70°C
Doporučená teplota horké vody:	65°C
Přípoje:	G1/2 & G3/4
Průtokové množství při 0,3 MPa:	
10750180 (1 Spotřebič)	44 l/min
10750180 (2 Spotřebič)	55 l/min
10650180	25 l/min
10971180	55 l/min
28486180	50 l/min
Tepelná desinfekce:	max. 70°C/4 min

Výrobky Hansgrohe jsou vhodné pro přímý kontakt s pitnou vodou. Vlastní jištění proti zpětnému nasátí.

POPIS SYMBOLŮ

 Nepoužívat silikon s obsahem kyseliny octové!

 ROZMĚRY (viz strana 31)

 PŘÍKLADY MONTÁŽE (viz strana 32)
Uspořádání modulů přizpůsobte stavebním podmínkám.

 SERVISNÍ DÍLY (viz strana 57)

 ELEKTROINSTALATÉR

 ÚDRŽBA
U zpětných ventilů se musí podle DIN EN 1717 v souladu s národními nebo regionálními předpisy testovat jejich funkčnost (alespoň jednou ročně).

 Připojení vody DN20
Teplá voda

 Připojení vody DN20
Studená voda

 STŘED SPRCHOVÉ VANY

 VODU ZAPOJIT / VODU ODPOJIT

 OCHRANNÁ TRUBKA EN20

 NOSTE OCHRANNÉ RUKAVICE

 ELEKTRICKÝ PROUD ZAP / VYP

POSTUP MONTÁŽE

 UTĚSNIT ODPADY
Nepoužitý vývod musí být utěsněn zaslepovací zátkou.

 SPÁD POTRUBÍ
Vodovodní potrubí pro boční sprchy nainstalovat se spádem.

PE VYROVNÁNÍ POTENCIÁLŮ

N NULOVÝ VODIČ

L VODIČ

FI OCHRANNÝ SPÍNAČ FI

 SPÍNAČ SVĚTLA

 TRANSFORMÁTOR

 OSVĚTLOVACÍ PROSTŘEDEK

 KONEKTOROVÁ SPOJENÍ

 ZESILOVAČ PRO REPRODUKTORY

 NUTNÉ VYZTUŽENÍ STĚNY
V této oblasti je potřebné zesílení stěny.

 ZKUŠEBNÍ ZNAČKA (viz strana 57)

BEZPEČNOSTNÉ POKYNY

- ⚠ Pri montáži musíte nosiť rukavice, aby ste predišli pomliaždeninám a rezným poraneniam.
- ⚠ Produkt sa smie používať len na kúpanie a telesnú hygienu.
- ⚠ Produkt nesmú bez dozoru používať deti, ako aj dospelé osoby s telesným, duševným a/alebo zmyslovým postihnutím. Produkt nesmú používať ani osoby, ktoré sú pod vplyvom alkoholu alebo drog.
- ⚠ Vyhýbajte sa kontaktu vodného lúča sprchy s citlivými miestami tela (napr. oči). Dodržiavajte dostatočnú vzdialenosť medzi sprchou a telom.
- ⚠ Veľké rozdiely v tlaku medzi prípojkami studenej a teplej vody musia byť vyrovnané.

ELEKTRICKÉ PRIPOJENIE

- ⚠ Elektroinštalácia môže byť vykonaná len kvalifikovaným elektrikárom!
- ⚠ Predinštalujte zásobovanie elektrinou 230V/N/PE/50Hz (dĺžka: 0,3 m)
- ⚠ Pri elektroinštalácii je nutné dodržiavať príslušné predpisy VDE, krajiny a EVU v príslušnom platnom vydaní.

OCHRANNÉ ZARIADENIE CHYBNÉHO PRÚDU

- ⚠ Prívod musí byť chránený prúdovým chráničom (RCD/FI) pre chybový prúd s merným rozdielovým prúdom ≤ 30 mA.

ELEKTROINŠTALATÉR

- ⚠ Inštalčné a skúšobné práce musí vykonávať len autorizovaný elektrikár pri zohľadnení noriem VDE 0100, časť 701 a IEC 60364-7-701.

POKYNY PRE MONTÁŽ

- / Pred montážou musíte produkt skontrolovať, či nebol počas transportu poškodený. Po zabudovaní nebudú uznané žiadne škody spôsobené transportom alebo poškodenia povrchu.
- / Ledningarna och blandaren måste monteras, spolás igenom och kontrolleras enligt de gällande normerna.
- / Je potrebné dodržiavať smernice o inštalácii, ktoré sú práve teraz platné v krajinách.
- / Pri montáži produktu kvalifikovanou osobou treba dávať pozor na to, aby bola upevňovacia plocha v celej oblasti upevnenia rovná (žiadne vyčnievajúce medzery alebo zapustenia obkladov), aby štruktúra steny bola vhodná pre montáž produktu a nemá žiadne slabé miesta.
- / Pri vŕtaní dajte pozor na elektrické vedenia a vodovodné potrubia!
- / Pripustnosť odpadu musí byť dostatočne dimenzovaná.

TECHNICKÉ ÚDAJE

Prevádzkový tlak:	max. 1 MPa
Doporučený prevádzkový tlak:	0,1 - 0,5 MPa
Skúšobný tlak:	1,6 MPa (1 MPa = 10 bar = 147 PSI)
Teplota teplej vody:	max. 70°C
Doporučená teplota teplej vody:	65°C
Pripoje:	G1/2 & G3/4
Prietokové množstvo pri 0,3 MPa:	
10750180 (1 Spotřebič)	44 l/min
10750180 (2 Spotřebič)	55 l/min
10650180	25 l/min
10971180	55 l/min
28486180	50 l/min
Termická dezinfekcia:	max. 70°C / 4 min

Výrobok je koncipovaný výhradne pre pitnú vodu!
Vlastná poisťka proti spätnému nasatiu.

POPIS SYMBOLOV

 Nepoužívať silikón s obsahom kyseliny octovej!	 STRED SPRCHOVEJ VANE	 VYROVNANIE POTENCIÁLOV
 ROZMERY (viď strana 31)	 ZAPOJIŤ VODU / ODPOJIŤ VODU	 NULOVÝ VODIČ
 PRÍKLADY MONTÁŽE (viď strana 32) Usporiadanie modulov prispôbte stavebným podmienkam.	 OCHRANNÁ RÚRA EN20	 VODIČ
 SERVISNÉ DIELY (viď strana 57)	 NOSTE OCHRANNÉ RUKAVICE	 FI OCHRANNÝ SPÍNAČ
 ELEKTROINŠTALATÉR	 ZAP./VYP. PRÚD	 SVETELNÝ SPÍNAČ
 ÚDRŽBA Pri spätných ventiloch sa musí podľa DIN EN 1717 v súlade s národnými alebo regionálnymi predpismi testovať ich funkčnosť (aspoň raz ročne).	 POSTUP MONTÁŽE	 TRANSFORMÁTOR
	 UTESNIŤ ODVODY Nepoužitý vývod musí byť zaslepený zátkou.	 OSVETĽOVACÍ PROSTRIEDOK
	 SKLON VEDENIA Vodovodné potrubie pre bočné sprchy vyspádovať.	 KONEKTOROVÉ SPOJENIA
		 ZOSILOVAČ PRE REPRODUKTOROV
		 POTREBNÉ ZOSILNENIE STENY V tejto oblasti je potrebné zosilnenie steny.
 Prípojenie vody DN20 Teplá voda		 OSVEDČENIE O SKÚŠKE (viď strana 57)
 Prípojenie vody DN20 Studená voda		

安全技巧

- △ 装配时为避免挤压和切割受伤，必须戴上手套。
- △ 本产品只允许作为洗浴、卫生和洁身之用。
- △ 不得让儿童和肢体、精神和/或意识有障碍的成人在不受监管的情况下使用淋浴系统。受酒精或毒品影响的人员不得使用淋浴系统。
- △ 必须避免让身体敏感部位（如眼睛）接触到莲蓬头喷水。必须保持莲蓬头与人头之间有足够的安全距离。
- △ 冷热水管间过大的压力差必须予以平衡。

△ 电气连接

- △ 电气接口只能由电气专业人员进行操作！
- △ 预安装供电电缆230V/NPE/50Hz（长度 0.3米）
- △ 在进行电力安装的过程中，遵守有效的德国电工规范以及本国的电力危险防护规定。

缺陷电流保护装置

- △ 保险装置必须是额定电流 ≤ 30 mA的故障电流保护装置。

△ 电气安装人员

- △ 安装和检查工作由有资质的电气专业人员按照德国电气工程协会VDE 0100标准中第701项和国际电工委员会IEC 60364-7-701标准执行。

安装提示

- / 安装前必须检查产品是否受到运输损害。安装后将不认可运输损害或表面损伤。
- / 管道和阀门必须根据通用标准进行安装、冲洗和检查。
- / 请遵守当地国家现行的安装规定。
- / 由有资格的专业人员进行产品安装时请注意：在所有加固区域中，加固表面是否平整（无突出的接缝或瓷砖），墙体结构是否适合产品安装且未显露出任何缺点。
- / 钻孔时请注意电线和水管！
- / 废水管的性能必须具有充足的尺寸。

技术参数

工作压强:	最大 1 MPa
推荐工作压强:	0,1 - 0,5 MPa
测试压强:	1,6 MPa
	(1 MPa = 10 bar = 147 PSI)
热水温度:	最大 70°C
推荐热水温度:	65°C
连接管线:	G1/2 & G3/4
流量 钟 ^{0,3} MPa:	
10750180 (1 用户)	44 升/分钟
10750180 (2 用户)	55 升/分钟
10650180	25 升/分钟
10971180	55 升/分钟
28486180	50 升/分钟
热力消毒:	最大 70°C / 4 分钟

该产品专为饮用水设计！
自动防止回流

符号说明

	请勿使用含有乙酸的硅胶！		中心淋浴盆		电位均衡
	大小 (参见第页 31)		调节水 / 关闭水流		零线
	安装示意 (参见第页 32) 按照构造的实际情况布置模块。		空管EN20		导线
	备用零件 (参见第页 57)		配戴保护手套		FI保护开关
	电气安装人员		电流 接通/断开		照明开关
	保养 单向阀必须在符合国家或当地的法律的情况下按照DIN EN 1717定期检查（至少一年一次）。		装配顺序		变压器
			堵塞支路 插入不使用的插座。		灯具
	水连接 DN20 热水		管道梯度 安装水管，用于带有梯度的淋浴器。		插座连接
	水连接 DN20 冷水				扬声器放大器
					墙壁必要加强的区域 该区域需要一个加固边壁。
					检验标记 (参见第页 57)

УКАЗАНИЯ ПО ТЕХНИКЕ БЕЗОПАСНОСТИ

- ⚠ Во время монтажа следует надеть перчатки во избежание прищемления и порезов.
- ⚠ Изделие разрешается использовать только в гигиенических целях: для принятия ванны и личной гигиены.
- ⚠ Дети, а также взрослые с физическими, умственными и/или сенсорными недостатками должны пользоваться изделием только под присмотром. Запрещается пользоваться изделием в состоянии алкогольного или наркотического опьянения.
- ⚠ Не допускайте попадания струи воды из разбрызгивателя на чувствительные части тела (например, на глаза). Разбрызгиватель следует устанавливать на достаточном расстоянии от тела.
- ⚠ донного клапа. Перед установкой смесителя необходимо регулировочными кранами выровнять давление холодной и горячей воды при помощи вентилей регулирующих подачу воды в квартиру.

ЭЛЕКТРОПОДКЛЮЧЕНИЕ

- ⚠ Электрическое подключение разрешается выполнять только специалисту-электрику!
- ⚠ Электропитание 230V/N/PE/50Hz (длина: 0,3 м) инсталлировать заранее.
- ⚠ При электромонтаже следует соблюдать соответствующие предписания Союза немецких электротехников (VDE), государственные нормы и предписания Европейского объединения исследований несчастных случаев (EVU) в действующей редакции.

НЕИСПРАВНОСТЬ ЭЛЕКТРООБОРУДОВАНИЯ И ЗАЩИТНЫХ ПРИСПОСОБЛЕНИЙ

- ⚠ Требуется организовать защиту с помощью устройства защитного отключения (выключателя дифференциального тока) с уставкой дифференциального тока ≤ 30 мА.

ЭЛЕКТРОМОНТЕР

- ⚠ Установочные и проверочные работы проводятся специалистами-электриками, имеющими допуск к работе, с соблюдением VDE 0100, часть 701, и IEC 60364-7-701.

УКАЗАНИЯ ПО МОНТАЖУ

- / Перед монтажом следует проверить изделие на предмет повреждений при перевозке. После монтажа претензии о возмещении ущерба за повреждения при перевозке или повреждении поверхностей не принимаются.
- / Трубы и арматура должны быть установлены, промыты и проверены в соответствии с действующими нормами.
- / Необходимо соблюдать требования по монтажу, действующие в соответствующих странах.
- / Во время монтажа изделия квалифицированным персоналом поверхность крепления должна быть ровной по всей области крепления (не допускайте выступающих стыков или перекоса облицовочной плитки); для монтажа изделия следует использовать подходящую стену достаточной прочности.
- / При сверлении обратить внимание на проложенные трубы или электрический кабель!
- / Слив должен иметь достаточную производительность.

ТЕХНИЧЕСКИЕ ДАННЫЕ

Рабочее давление:	не более. 1 МПа
Рекомендуемое рабочее давление:	0,1 - 0,5 МПа
Давлении:	1,6 МПа (1 МПа = 10 bar = 147 PSI)
Температура горячей воды:	не более. 70°C
Рекомендуемая темп. гор. воды:	65°C
Подключение:	G1/2 & G3/4
Расход при 0,3 МПа:	
10750180 (1 Потребитель)	44 л/мин
10750180 (2 Потребитель)	55 л/мин
10650180	25 л/мин
10971180	55 л/мин
28486180	50 л/мин
Термическая дезинфекция:	не более. 70°C/4 мин

Изделие предназначено исключительно для питьевой воды!
укомплектован клапаном обратного тока воды

ОПИСАНИЕ СИМВОЛОВ

	Не применяйте силикон, содержащий уксусную кислоту.		СЕРЕДИНА ДУШЕВОЙ ВАННЫ		ВЫРАВНИВАНИЕ ПОТЕНЦИАЛОВ
	РАЗМЕРЫ (см. стр. 31)		ОТКРОЙТЕ ВОДУ / ЗАКРОЙТЕ ВОДУ		НУЛЕВОЙ ПРОВОД
	ВАРИАНТЫ УСТАНОВКИ (см. стр. 32)		ПУСТАЯ ТРУБА EN20		ПРОВОД
	Подогнать расположение модулей в соответствии с конструктивными параметрами.		НОСИТЕ ЗАЩИТНЫЕ ПЕРЧАТКИ		ЗАЩИТНОЕ РЕЛЕ FI
	КОМПЛЕКТ (см. стр. 57)		ТОК ВКЛ. / ВЫКЛ.		ВЫКЛЮЧАТЕЛЬ ОСВЕЩЕНИЯ
	ЭЛЕКТРОМОНТЕР		ПОРЯДОК МОНТАЖА		ТРАНСФОРМАТОР
	ТЕХНИЧЕСКОЕ ОБСЛУЖИВАНИЕ		ЗАГЛУШИТЬ ОТХОДЯЩИЕ ЛИНИИ		ОСВЕТИТЕЛЬНОЕ СРЕДСТВО
	Защита обратного тока должна регулярно проверяться (минимум один раз в год) по стандарту DIN EN 1717 или в соответствии с национальными или региональными нормативами		Ненужный выход необходимо уплотнить с помощью заглушки. НАПОР ПРОВОДА		ШТЕКЕРНЫЕ СОЕДИНЕНИЯ
			Водопроводы для боковых душей прокладывают под наклоном.		УСИЛИТЕЛЬ ДЛЯ ДИНАМИКОВ
					НЕОБХОДИМО УСИЛЕНИЕ СТЕНЫ
					В этой области требуется укрепление стены.
	Подключение воды DN20				ЗНАК ТЕХНИЧЕСКОГО КОНТРОЛЯ (см. стр. 57)
	Теплая вода				
	Подключение воды DN20				
	Холодная вода				

BIZTONSÁGI UTASÍTÁSOK

- ⚠ A szerelésnél a zúzódások és vágási sérülések elkerülése érdekében kesztyűt kell viselni.
- ⚠ A terméket csak fürdéshez, mosakodáshoz, és egészségügyi tisztálkodáshoz szabad használni.
- ⚠ Gyermekek, valamint testileg, szellemileg fogyatékos és/vagy érzékelésben korlátozott személyek nem használhatják felügyelet nélkül a terméket. Alkohol és kábítószer befolyása alatt álló személyek nem használhatják a terméket.
- ⚠ Kerülni kell a zuhanyugár érintkezését érzékeny testrészekkel (pl. szemek). Be kell tartani a megfelelő távolságot a zuhanyfej és a test között.
- ⚠ A hidegvíz- és a melegvíz-csatlakozások közötti nagy nyomáskülönbséget kikell egyenlíteni!

⚠ ELEKTROMOS CSATLAKOZÁS

- ⚠ Az elektromos hálózathoz való csatlakoztatást csak szakember végezheti el!
- ⚠ Áramellátást 230V/N/PE/50Hz (hosszúság: 0,3 m) előre telepíteni.
- ⚠ Az elektromos szerelés közben a mindenkor érvényes keretek között be kell tartani a megfelelő VDE, országspecifikus, és EVU előírásokat.

HIBAÁRAM-VÉDŐBERENDEZÉS

- ⚠ A biztosítást egy hibaáram-mentesítő (RCD/FI) útján, egy 30 mA-nál kisebb hálózati váltóáram segítségével kell megvalósítani.

⚠ ELEKTROMOS SZAKEMBER

- ⚠ Az installációs és ellenőrző munkákat jóváhagyott elektromos szakembernek kell elvégezni, a VDE 0100 701. része és az IEC 60364-7-701, figyelembevétele mellett.

SZERELÉSI UTASÍTÁSOK

- / A szerelés előtt ellenőrizni kell, hogy a terméknek nincs-e szállítási sérülése. Beépítés után a szállítási- vagy felületi sérüléseket nem ismerik el.
- / A vezetékeket és a csaptelepet az érvényes szabványoknak megfelelően kell felszerelni, öblíteni és ellenőrizni
- / Az egyes országokban érvényes installációs irányelveket be kell tartani.
- / A termék képzett szakember általi felszerelése esetén ügyelni kell arra, hogy a rögzítési felület teljesen sima legyen (ne legyen kiálló fuga vagy csempé), a fal szerkezete a termék felszerelésére alkalmas legyen, és ne legyen gyenge pontja.
- / Fűrés esetén ügyelni kell az áram- és vízvezetékekkel
- / A kifolyási teljesítményt megfelelően kell dimenzionálni.

MŰSZAKI ADATOK

Üzemi nyomás:	max. 1 MPa
Ajánlott üzemi nyomás:	0,1 - 0,5 MPa
Nyomáspróba:	1,6 MPa
	(1 MPa = 10 bar = 147 PSI)
Forróvíz hőmérséklet:	max. 70°C
Forróvíz javasolt hőmérséklete:	65°C
Csatlakozás:	G1/2 & G3/4
Átfolyási teljesítmény 0,3 MPa:	
10750180 (1 Felhasználó)	44 l/perc
10750180 (2 Felhasználó)	55 l/perc
10650180	25 l/perc
10971180	55 l/perc
28486180	50 l/perc
Termikus fertőtlenítés:	max. 70°C / 4 perc

A terméket kizárólag ivóvízhez tervezték!
Visszafolyás gátlóval

SZIMBÓLUMOK LEÍRÁSA

	Ne használjon ecetsavtartalmú szilikon!		ZUHANYTÁLCA KÖZEPE		POTENCIÁLKIEGYENLÍTÉS
	MÉRETET (lásd a oldalon 31)		NYISSUK MEG A VIZET. / ZÁRJUK EL A VIZET		NULLAVEZETŐ
	SZERELÉSI PÉLDÁK (lásd a oldalon 32)		EN20 ÜRES CSŐ		VEZETŐ
	A modulok elrendezését az építési adottságokhoz kell igazítani.		VISELJEN VÉDKESZTYŰT		FI-VÉDŐKAPCSOLÓ
	TARTOZÉKOK (lásd a oldalon 57)		ÁRAM BE / KI		VILÁGÍTÁSKAPCSOLÓ
	ELEKTROMOS SZAKEMBER		SZERELÉSI SORREND		TRAFÓ
	KARBANTARTÁS		KIMENETEKET LEZÁRNI		VILÁGÍTÁS
	A visszafolyásgátlók működése a DIN EN 1717 szabványnak megfelelően, a nemzeti vagy területi rendelkezésekkel összhangban, évente egyszer ellenőrizendő!		VEZETÉK ESÉSE		DUGASZOLÓ CSATLAKOZÁSOK
			Az oldalzuhanyokhoz a vízvezeték lejtéssel ajánlott beszerezni.		ERŐSÍTŐ A HANGSZÓRÓHOZ
	Vízcsatlakozás DN20				SZÜKSÉGES A FAL MEGERŐSÍTÉSE
	Melegvíz				VIZSGAJEL (lásd a oldalon 57)
	Vízcsatlakozás DN20				Ezen a területen a fal megerősítésére van szükség.
	Hidegvíz				

TURVALLISUUSOHJEET

- ⚠ Asennuksessa on käytettävä käsiineitä puristumien ja viiltojen aiheuttamien tapaturmien estämiseksi.
- ⚠ Tuotetta saa käyttää ainoastaan kylpy-, hygienia- ja puhdistustarkoituksiin.
- ⚠ Lapset ja ruumiillisesti, henkisesti ja/tai aistillisesti rajoittuneet aikuiset eivät saa käyttää suihkujärjestelmää ilman valvontaa. Alkoholien tai huumeiden vaikutuksessa olevat henkilöt eivät saa käyttää suihkujärjestelmää.
- ⚠ Suihkuveden kontaktia herkkien ruumiinosien (esim. silmien) kanssa on vältettävä. Suihkun ja vartalon välissä on oltava riittävä väli.
- ⚠ Suuret paine-erot kylmä- ja kuumavesiliitäntöjen välillä on tasattava.

⚠ SÄHKÖLIITÄNTÄ

- ⚠ Sähköliitännän saa tehdä vain sähköalan ammattilainen!
- ⚠ Tehonsyöttö 230V/N/PE/50Hz (pituus: 0,3 m) esiasennetaan.
- ⚠ Sähköasennuksessa on noudatettava voimassa olevia, asiaa koskevia VDE-, EVU- ja paikallisia määräyksiä.

VIKAVIRTASUOJAKYTKIN

- ⚠ Varmistus on tehtävä vikavirta-suojalaitetta (RCD/FI), jonka vikavirta-asetus on ≤ 30 mA, käyttäen.

⚠ SÄHKÖASENTAJA

- ⚠ Hyväksytyt sähköammattilaisen on suoritettava sähköasennus- ja tarkastustyöt VDE 0100 osa 701 ja IEC 60364-7-701 mukaisesti.

ASENNUSOHJEET









- / Ennen asennusta on tarkastettava tuotteen mahdolliset kuljetusvahingot. Asennuksen jälkeen kuljetus- ja pintavaurioita ei hyväksytä.
- / Putket ja hana on asennettava, huuhdeltava ja tarkastettava voimassa olevien standardien mukaisesti.
- / Jokaisessa maassa on noudatettava siellä päteviä asennusohjeita.
- / Pätevän ammattihenkilöstön asentaessa tuotetta on otettava huomioon, että kiinnityspinnan on oltava koko kiinnitysalueelta tasainen (ei korkeita saumoja tai laattojen yhtymäkohtia), seinän rakenne soveltuu tuotteen asennukseen eikä siinä ole heikkoja kohtia.
- / Varo porattaessa sähkö- ja vesijohtoja!
- / Poisvirtausteho on mitoittettava riittävän suureksi.

TEKNISET TIEDOT

Käyttöpaine:	maks. 1 MPa
Suosittelut käyttöpaine:	0,1 - 0,5 MPa
Koestuspaine:	1,6 MPa
	(1 MPa = 10 bar = 147 PSI)
Kuuman veden lämpötila:	maks. 70°C
Kuuman veden suosituslämpötila:	65°C
Liittimet:	G1/2 & G3/4
Läpivirtausmäärä 0,3 MPa paineella:	
10750180 (1 Kuluttaja)	44 l/min
10750180 (2 Kuluttaja)	55 l/min
10650180	25 l/min
10971180	55 l/min
28486180	50 l/min
Lämpödesinfektio:	maks. 70°C / 4 min

Tuote on suunniteltu käytettäväksi ainoastaan juomaveden kanssa!
Estää itsestään paluuvirtauksen

MERKIN KUVAUS

-  Älä käytä etikkahappopitoista silikonia!
-  MITAT (katso sivu 31)
-  ASENNUSESIMERKKEJÄ (katso sivu 32)
Moduulien järjestys sovitetaan rakenteellisten vaatimusten mukaan.
-  VARAOSAT (katso sivu 57)
-  SÄHKÖASENTAJA
-  HUOLTO
Vastaventtiilien toiminta on tarkastettava säännöllisesti paikallisten ja kansallisten määräysten mukaisesti (DIN EN 1717, vähintään kerran vuodessa).
-  Vesiliitäntä DN20
Lämmin vesi
-  Vesiliitäntä DN20
Kylmä vesi

X

SUIHKUALTAAN KESKUSTA



AVAA VEDENSYÖTTÖ / SULJE VEDENTULO



ASENNUSPUTKI EN20



KÄYTÄ SUOJAKÄSINEITÄ



SÄHKÖ PÄÄLLÄ / POIS PÄÄLTÄ



ASENNUSJÄRJESTYS



POISTOKOHDAT TUKITAAN

Käyttämätön lähtöliitin on suljettava sulikutul-palla.



PUTKIEN KALTEVUUS

Vie sivusuuhkujen syöttöputket alaspäin laskevasti.

PE

POTENTIAALITASAUS

N

NOLLAJOHDIN

L

JOHDIN

FI

FI-SUOJAKYTKIN



VALOKYTKIN



MUUNTAJA



VALONLÄHDE



PISTOKELIITÄNTÄ



KAIUTTIMIEN VAHVISTIN



SEINÄN VAHVISTUS ON TARPEEN

Tässä kohdassa seinää on vahvistettava



KOESTUSMERKKI (katso sivu 57)

SÄKERHETSANVISNINGAR

- ⚠ Handskar ska bäras under monteringsarbetet så att man kan undvika kläm- och skärskadorna werden.
- ⚠ Produkten får bara användas till kroppshygien med bad och dusch.
- ⚠ Barn samt vuxna med fysiska, psykiska eller sensoriska funktionshinder får inte använda produkten ensamma. Personer som är påverkade av alkohol- eller droger får inte använda produkten.
- ⚠ Undvik att rikta duschstrålarna mot känsliga kroppsdelar (t. ex. ögonen). Det måste finnas ett tillräckligt stort avstånd mellan duschen och kroppen.
- ⚠ Stora tryckskillnader mellan anslutningarna för varmt och kallt vatten måste utjämnas.

ELEKTRISK ANSLUTNING

- ⚠ Elanslutningen får endast utföras av en elektroinstallatör!
- ⚠ Förinstallera strömförsörjning 230V/N/PE/50Hz (längd: 0,3 m).
- ⚠ Vid elinstallationen ska gällande föreskrifter från VDE [branschorganisation Verband der Elektrotechnik, Elektronik und Informationstechnik e.V. Bestimmungen]-, land- och EVU [elbolag- Elektrizitätsversorgungsunternehmen] i aktuell utgåva följas.

FELSTRÖMS-SKYDDSANORDNING

- ⚠ Säkringen måste ske via en felströms-skyddsanordning (RCD/FI) med en differensström på ≤ 30 mA.

ELINSTALLATÖR

- ⚠ Installations- och kontrollarbeten ska utföras av behörig elektroinstallatör, enligt VDE 0100 del 701 o. IEC 60364-7-701.

MONTERINGSANVISNINGAR

- / Det måste undersökas om produkten har transportskador innan den monteras. Efter monteringen accepteras inga transport- eller ytskiktsskador.
- / Ledningarna och blandaren måste monteras, spolas igenom och kontrolleras enligt de gällande normerna.
- / De installationsriktlinjer som gäller i länderna ska följas.
- / När kvalificerad fackpersonal monterar produkten är det viktigt att fästytan är plan över hela fästsättningsområdet (inga fogar som sticker ut eller kakelförskjutning) och att väggstrukturen är lämplig för en montering av produkten och inte har några svaga punkter.
- / Tänk på elledningarna och vattenrör vid borrar!
- / Tönningskapaciteten måste vara tillräcklig.

TEKNISKA DATA

Driftstryck:	max. 1 MPa
Rek. driftstryck:	0,1 - 0,5 MPa
Tryck vid provtryckning:	1,6 MPa (1 MPa = 10 bar = 147 PSI)
Varmvattentemperatur:	max. 70°C
Rek. varmvattentemp.:	65°C
Anslutningar:	G1/2 & G3/4
Flödeskapacitet vid 0,3 MPa:	
10750180 (1 Förbrukare)	44 l/min
10750180 (2 Förbrukare)	55 l/min
10650180	25 l/min
10971180	55 l/min
28486180	50 l/min
Termisk desinfektion:	max. 70°C / 4 min

Produkten är enbart avsedd för dricksvatten!
Självspärr mot återflöde

SYMBOLFÖRKLARING

 Använd inte silikon som innehåller ättiksyra!

 MÅTTEN (se sidan 31)

 MONTERINGSEXEMPEL (se sidan 32)
Anpassa modulernas placering till de förutsättningar som gäller på platsen.

 RESERVDELAR (se sidan 57)

 ELINSTALLATÖR

 SKÖTSEL
Backventilens funktion måste kontrolleras regelbundet enligt nationella eller regionala bestämmelser i enlighet med DIN EN 1717 (minst en gång per år).

 Vattenanslutning DN20
Varmvatten

 Vattenanslutning DN20
Kallvatten

 MITTEN AV DUSCHKARET

 SLÅ PÅ VATTEN / STÄNG AV VATTNET

 IHÅLIGT RÖR EN20

 BÄR SKYDDSHANDSKAR

 STRÖM PÅ / AV

MONTERINGSFÖLJD

 PLUGGA IGEN AVLOPP
Det utlopp som inte behövs måste tätas med en blindstopp.

 LEDNINGSFALL
Drag vattenledningarna till sidoduschar med fall.

PE POTENTIALUTJÄMNING

N NEUTRALLEDARE

L LEDARE

FI JORDFELSBRYTARE

 STRÖMBRYTARE

 TRANSFORMATOR

 GLÖDLAMPA

 STICKANSLUTNING

 FÖRSTÄRKARE TILL HÖGTALARE

 VÄGGFÖRSTÄRKNING NÖDVÄNDIG
Šioje zonoje būtinas sienos sutvirtinimas

 TESTSIGILL (se sidan 57)

SAUGUMO TECHNIKOS NURODYMAI

- ⚠ Apsaugai nuo užspaudimo ir įsijovimo montavimo metu mūvėkite pirštines.
- ⚠ Gaminys turi būti naudojamas tik maudymuisi, kūno higienai ir švarai palaikyti.
- ⚠ Gaminį draudžiama naudoti vaikams, taip pat suaugusiems su fizine, dvasine negale ir (arba) sensorikos sutrikimais. Gaminį taip pat draudžiama naudoti asmenims, apsvaigusiems nuo alkoholio arba narkotikų.
- ⚠ Būtina vengti dušo vandens srovės kontakto su jautriomis kūno vietomis (pvz., akimis). Todėl būtina laikytis tinkamo atstumo nuo dušo.
- ⚠ Turi būti išlyginti šalto ir karšto slėgio nelygumai.

ELEKTROS PRIJUNGIMAS

- ⚠ Elektrą prijungti turi elektrikas!
- ⚠ Iš anksto įrengtas el. maitinimas 230V/N/PE/50Hz (ilgis 0,3 m).
- ⚠ Montuodami elektros įrangą, laikykitės galiojančių Vokietijos elektrotechnikos asociacijos (VDE), žemės ir - energijos tiekimo įmonės reikalavimų.

APSAUGOS NUO GEDIMO PRIETAISAS

- ⚠ Apsauginis įrenginys (RCD/FI) apsaugo nuo nebalanso srovės, kai srovių skirtumas ≤ 30 mA.

ELEKTROMONTUOTOJAS

- ⚠ Instaliavimo ir tikrinimo darbus gali atlikti tik kvalifikuoti elektrikai pagal VDE 0100, 701 d. ir IEC 60364-7-701 standartų reikalavimus

MONTAVIMO INSTRUKCIJA









- / Prieš montuojant būtina patikrinti, ar gaminys nebuvo pažeistas transportavimo metu. Sumontavus pretenzijos dėl transportavimo ir paviršiaus pažeidimų nepriimamos.
- / Vamzdžiai ir sujungimai turi būti montuojami, plaunami ir tikrinami pagal galiojančias normas.
- / Laikykitės atitinkamoje šalyje galiojančių direktyvų dėl įrengimo.
- / Atlikdami montavimo darbus, kvalifikuoti darbuotojai turi atkreipti dėmesį, kad pritvirtinimo plokštuma būtų lygi (be išsikišusių siūlių ar perkreiptų plytelių), sienų konstrukcija tiktų gaminiai montuoti ir neturėtų jokių trūkumų.
- / Gręžiant atkreipkite dėmesį į esamas elektros ir vandens linijas
- / Vandens nubėgimas privalo būti pakankamas.









TECHNINIAI DUOMENYS

Darbinis slėgis:	ne daugiau kaip 1 MPa
Rekomenduojamas slėgis:	0,1 - 0,5 MPa
Bandomasis slėgis:	1,6 MPa
	(1 MPa = 10 barų = 147 PSI)
Karšto vandens temperatūra:	ne daugiau kaip 70°C
Rekomenduojama karšto vandens temperatūra:	65°C
Prijungimas:	G1/2 & G3/4
Vandens pralaidumas, esant 0,3 MPa slėgiui:	
10750180 (1 Vartotojas)	44 l/min
10750180 (2 Vartotojas)	55 l/min
10650180	25 l/min
10971180	55 l/min
28486180	50 l/min
Terminis dezinfekavimas:	ne daugiau kaip 70°C / 4 min

Produktas skirtas tik geriamajam vandeniui!
Su atbuliniu vožtuvu

SIMBOLIO APRAŠYMAS

-  Nenaudokite silikono, kurio sudėtyje yra acto rūgšties!
-  IŠMATAVIMAI (žr. psl. 31)
-  MONTAVIMO PAVYZDŽIAI (žr. psl. 32)
Modulių išdėstymas pritaikomas prie esamų techninių sąlygų.
-  ATSARGINĖS DALYS (žr. psl. 57)
-  ELEKTROMONTUOTOJAS
-  TECHNINIS APTARNAVIMAS
Atbulinio vožtuvo apsauga privalo būti tikrinama reguliariai (mažiausiai kartą per metus) pagal DIN EN1717 arba pagal galiojančias nacionalines arba regionines normas.
-  Vandens prijungimas DN20
Šiltas vanduo
-  Vandens prijungimas DN20
Šaltas vanduo

-  DUŠO PADĖKLO CENTRAS
-  ĮJUNKITE VANDENS TIEKIMĄ / IŠJUNGTI VANDENS TIEKIMĄ
-  TUŠČIAS VAMZDELIS EN20
-  MŪVĖKITE APSAUGINES PIRŠTINES
-  SROVĖ ĮJ. / IŠJ.
-  MONTAVIMO EIGA
-  UŽKIMŠIMAS ATLIEKOMIS
Nenaudojamą išėjimą užkloti.
-  SLĖGIS VAMZDYNE
Privesti vamzdžius šoniniams purkštukams.

-  PE POTENCIALŲ IŠLYGINIMAS
-  N NULINIS LAIDAS
-  L LAIDAS
-  FI APSAUGINIS JUNGIKLIS
-  ELEKTROS JUNGIKLIS
-  TRANSFORMATORIUS
-  ŠVIESOS ŠALTINIS
-  KIŠTUKINĖS JUNGTYS
-  GARSIAKALBIO STIPRINTUVAS
-  BŪTINAS SIENOS SUTVIRTINIMAS
Šioje zonoje būtinas sienos sutvirtinimas
-  BANDYMO PAŽYMA (žr. psl. 57)

SIGURNOSNE UPUTE

- ⚠ Prilikom montaže se radi sprječavanja prignječenja i posjekotina moraju nositi rukavice.
- ⚠ Proizvod se smije primjenjivati samo za kupanje, tuširanje i osobnu higijenu.
- ⚠ Djeca, kao i tjelesno, mentalno i/ili senzorno hendikepirane odrasle osobe ne smiju se koristiti proizvodom bez nadzora. Osobe koje su pod utjecajem alkohola ili droga ne smiju se koristiti proizvodom.
- ⚠ Mora se izbjegavati kontakt mlaza iz tuša s osjetljivim dijelovima tijela (npr. očima). Tijelo korisnika mora biti dovoljno udaljeno od tuša.
- ⚠ Velika razlika u pritisku između vruće i hladne vode mora biti izbalansirana.

⚠ ELEKTRIČNI PRIKLJUČAK

- ⚠ Električnu smije priključiti samo ovlašteni električar!
- ⚠ Prethodno instalirajte električno napajanje 230V/N/PE/50Hz (duljina 0,3 m).
- ⚠ Prilikom provedbe električnih instalacijskih radova treba se pridržavati odgovarajućih, trenutno važećih propisa strukovne udruge elektrotehničara (u Njemačkoj: VDE), državnih propisa te propisa lokalnog poduzeća za distribuciju električne energije.

NADSTRUJNA ZAŠTITNA SKLOPKA

- ⚠ Vod se mora osigurati nadstrujnom zaštitnom sklopkom (RCD/FI) s nazivnom diferencijalnom strujom ≤ 30 mA.

⚠ ELEKTROINSTALATER

- ⚠ Električne instalacijske i ispitne radove smiju obavljati samo certificirani električari uz uvažavanje odredaba VDE 0100 dio 701 i IEC 60364-7-701.

UPUTE ZA MONTAŽU

- / Prije montaže mora se provjeriti je li proizvod oštećen prilikom transporta. Nakon ugradnje se ne priznaju nikakve reklamacije koje se odnose na površinska i transportna oštećenja.
- / Cijevi i armatura moraju biti postavljeni, isprani i testirani prema važećim normama.
- / Obvezno se moraju uvažiti propisi o instalacijama koji vrijede u dotičnoj zemlji.
- / Kada proizvod montira kvalificirano stručno osoblje treba paziti da čitava površina na koju se učvršćuje bude ravna (bez istaknutih fuga ili krivljenja pločica), da je zidna konstrukcija primjerena montaži proizvoda te da nema slabih mjesta.
- / Prilikom bušenja treba paziti na strujne vodove i vodovodne cijevi!
- / Potreban je optimalan protok vode

TEHNIČKI PODATCI

Najveći dopušteni tlak:	tlak 1 MPa
Preporučeni tlak:	0,1 - 0,5 MPa
Probni tlak:	1,6 MPa (1 MPa = 10 bar = 147 PSI)
Temperatura vruće vode:	tlak 70°C
Preporučena temperatura vruće vode:	65°C
Spojivi:	G1/2 & G3/4
Protok vode uz tlak od 0,3 MPa:	
10750180 (1 Trošilo)	44 l/min
10750180 (2 Trošilo)	55 l/min
10650180	25 l/min
10971180	55 l/min
28486180	50 l/min
Termička dezinfekcija:	tlak 70°C / 4 min

Proizvod je koncipiran isključivo za pitku vodu!

Funkcije samo-čišćenja

OPIS SIMBOLA

 Nemojte koristiti silikon koji sadrži octenu kiselinu!	 SREDINA TUŠ-KADA	 IZJEDNAČENJE POTENCIJALA
 MJERE (pogledaj stranicu 31)	 OTVORITE DOTOK VODE / ZATVORITE VODU	 NULTI VODIČ
 PRIMJERI INSTALACIJA (pogledaj stranicu 32) Raspored modula prilagodite uvjetima koji vladaju na mjestu postavljanja.	 PRAZNA CIJEV EN20	 VODIČ
 REZERVNI DJELOVI (pogledaj stranicu 57)	 NOSITE ZAŠTITNE RUKAVICE	 FI-SKLOPKA
 ELEKTROINSTALATER	 STRUJA UKLJ. / ISKLJ.	 PREKIDAČ ZA SVJETLO
 ODRŽAVANJE Ispravnost nepovratnog ventila mora se redovito provjeravati prema standardu DIN EN 1717 i u skladu sa važećim propisima (najmanje jednom godišnje).	 REDOSLIJED MONTAŽNIH RADOVA	 TRANSFORMATOR
 priključak na dovod vode DN20 Topla voda	 ODČEPLJIVANJE ODVOVA Potrebno je ostaviti zatvoren izlaz koji se ne koristi	 RASVJETNO TIJELO
 priključak na dovod vode DN20 Hladna voda	 NAGIB CIJEVI Položite vodovodne cijevi za bočni tuš s nagibom	 UTIČNI SPOJEVI
		 POJAČALO ZA ZVUČNIK
		 NEOPHODNO OJAČANJE ZIDA U ovom je području potrebno ojačanje zida.
		 OZNAKA TESTIRANJA (pogledaj stranicu 57)

GÜVENLİK UYARILARI

- ⚠ Montaj esnasında ezilme ve kesilme gibi yaralanmaları önlemek için eldiven kullanılmalıdır.
- ⚠ Ürün yalnızca banyo, hijyen ve beden temizliği amaçları doğrultusunda kullanılabilir.
- ⚠ Bedensel, ruhsal ve/veya sensörük engelli çocuk ve yetişkinler gözetimsiz olarak duş sistemini kullanmamalıdır. Alkol veya uyuşturucu etkisinde olanlar duş sistemini kullanmamalıdır.
- ⚠ Püskürtme başlıklarının hassas organlara teması (örn. gözler) önlenmelidir. Püskürtücü ile beden arasında yeterli mesafe bırakılmalıdır.
- ⚠ Sıcak ve soğuk su bağlantıları arasında büyük basınç farklılıkları varsa, bu basınç farklılıklarının dengelenmesi gerekir.

ELEKTRİK BAĞLANTISI

- ⚠ Elektrik bağlantısı sadece bir elektrik teknisyeni tarafından yapılmalıdır!
- ⚠ Elektrik beslemesi 230V/N/PE/50Hz (Uzunluk: 0,3 m) ön montaj.
- ⚠ Elektrik montajı sırasında güncel sürümdeki ilgili VDE, ülke ve EVU talimatlarına uyulmalıdır.

HATALI AKIM KORUMA DONANIMI

- ⚠ Emniyete alma, ≤ 30 mA ölçüm farkı akımı olan bir hatalı akım koruma tertibatı (RCD/FI) üzerinden gerçekleştirilmelidir.

ELEKTRONİK MONTAJCISI

- ⚠ Kurulum ve kontrol çalışmaları, VDE 0100 Bölüm 701 ve IEC 60364-7-701'i dikkate almak suretiyle, elektronik konusunda uzman yetkili bir kişi tarafından gerçekleştirilmelidir.

MONTAJ AÇIKLAMALARI









- / Montaj işleminden önce ürün nakliye hasarları yönünden kontrol edilmelidir. Montaj işleminden sonra nakliye veya yüzey hasarları için sorumluluk üstlenilmemektedir.
- / Boruların ve armatürün montajı, yıkanması ve kontrolü geçerli normlara göre yapılmalıdır.
- / Ülkelerde geçerli kurulum yönetmeliklerine riayet edilmelidir.
- / Ürünün yetkili uzman personel tarafından montajı yapılırken, sabitleme yüzeyinin sabitleme planının tüm alanında bulunduğu (derz veya fayans kayması olmamalıdır), duvar yapısının ürünün montajı için uygun olduğuna ve zayıf noktaları bulunmadığına dikkat edilmelidir.
- / Delik açarken elektrik ve su hatlarına dikkat!
- / Çıkış kapasitesi yeterli miktarda boyutlandırılmış olmalıdır.



TEKNİK BİLGİLER

İşletme basıncı:	azami 1 MPa
Tavsiye edilen işletme basıncı:	0,1 - 0,5 MPa
Kontrol basıncı:	1,6 MPa
	(1 MPa = 10 bar = 147 PSI)
Sıcak su sıcaklığı:	azami 70°C
Tavsiye edilen su ısı:	65°C
Bağlantılar:	G1/2 & G3/4
0,3 MPa'daki debi:	
10750180 (1 Tüketici)	44 l/dak
10750180 (2 Tüketici)	55 l/dak
10650180	25 l/dak
10971180	55 l/dak
28486180	50 l/dak
Termik dezenfeksiyon:	azami 70°C / 4 dak

Ürün sadece şebeke suyu için tasarlanmıştır!
Geri emme önleyici

SİMGE AÇIKLAMASI

-  Asetik asit içeren silikon kullanmayın!
-  ÖLÇÜLERİ (bakınız sayfa 31)
-  MONTAJ ÖRNEĞİ (bakınız sayfa 32)
Modüllerin düzenini yapı özelliklerine uyarlayın.
-  YEDEK PARÇALAR (bakınız sayfa 57)
-  ELEKTRONİK MONTAJCISI
-  BAKIM
DIN EN 1717 ve ulusal standartlar doğrultusunda Çek valfler düzenli olarak kontrol edilmelidir. (en az yılda bir kez)
-  Su bağlantısı DN20
Sıcak su
-  Su bağlantısı DN20
Soğuk su

-  DUŞ KÜVETİNİN ORTASI
-  SUYU AÇIN / SUYU KESİN
-  BOŞ BORU EN20
-  KORUYUCU EL DİVEN KULLANIN
-  AKIM AÇIK / KAPALI
-  MONTAJ SIRASI
-  ÇIKIŞLARI KAPATMA
Kullanılmayan çıkış bir kör tapayla izole edilmelidir.
-  HAT EĞİMLERİ
Yan duşların su hatlarını eğimli şekilde döşeyin.

-  PE POTANSİYEL DENGELMESİ
-  N SIFIR İLETKEN
-  L İLETKEN
-  FI FI KORUMA ŞALTERİ
-  IŞIK ŞALTERİ
-  TRAFÖ
-  AMPUL
-  SOKET BAĞLANTILARI
-  HOPARLÖR İÇİN GÜÇLENDİRİCİ
-  DUVAR TAKVİYESİ GEREKLİDİR
Bu alanda duvarın kalınlaştırılması gereklidir.
-  KONTROL İŞARETİ (bakınız sayfa 57)

INSTRUCȚIUNI DE SIGURANȚĂ

- ⚠ La montare utilizați mănuși pentru evitarea contuziunilor și tăierii mâinilor.
- ⚠ Produsul poate fi utilizat doar pentru spălarea, menținerea igienei și curățarea corpului.
- ⚠ Copiii și adulții cu dizabilități corporale, mintale și senzoriale nu pot utiliza sistemul de duș nesupravegheați. De asemenea este interzisă utilizarea sistemului de duș de către persoane, care se află sub influența alcoolului sau a drogurilor.
- ⚠ Evitați contactul jetului de apă cu părțile de corp sensibile (de ex. ochii). Țineți dușul la o distanță corespunzătoare de corp.
- ⚠ Diferențele de presiune mari între alimentarea cu apă rece și apă caldă trebuie echilibrate.

⚠ CONEXIUNE ELECTRICĂ

- ⚠ Racordarea la rețeaua electrică poate fi efectuată numai de către un tehnician electronist specializat!
- ⚠ Instalați în prealabil sistemul de alimentare cu curent 230V/N/PE/50Hz (lungime: 0,3 m).
- ⚠ La montarea instalației electrice trebuie respectate prescripțiile VDE (Verband Deutscher Elektrotechniker = Asociația Electrotehnicienilor din Germania), prescripțiile din țara respectivă și prescripțiile EVU (Elektrizitäts-Versorgungs-Unternehmen = Întreprinderile de Alimentare cu Electricitate), în versiunile actualizate.

DISPOZITIV DE PROTECȚIE ÎMPOTRIVA CURENTULUI REZIDUAL

- ⚠ Instalația trebuie asigurată printr-un dispozitiv de protecție împotriva curentului rezidual (RCD/FI) pentru curent rezidual măsurat de ≤ 30 mA.

⚠ ELECTRICIAN

- ⚠ Lucrările de instalare și de verificare trebuie efectuate de către electricieni specializați, ținând cont de VDE 0100 Partea 701 și IEC 60364-7-701.

INSTRUCȚIUNI DE MONTARE

- / Înainte de instalare verificați, dacă produsul prezintă deteriorări de transport. După instalare garanția nu acoperă deteriorările de transport și cele de suprafață.
- / Conductele și bateriile trebuie montate, spălate și verificate conform normelor în vigoare.
- / Respectați reglementările referitoare la instalare valabile în țara respectivă.
- / La montarea produsului de către un personal calificat se va avea grijă ca suprafața de fixare să fie plană pe toată aria de fixare (fără proeminențe ale rosturilor sau îmbinări între plăcile de faianță) și ca structura peretelui să fie corespunzătoare pentru fixarea produsului, să nu prezinte locuri cu rezistență redusă.
- / La efectuarea lucrărilor de găurire fiți atenți la conductele de apă și cablurile electrice!
- / Debitul de golire trebuie să fie suficient de mare.

DATE TEHNICE

Presiune de funcționare:	max. 1 MPa
Presiune de funcționare recomandată:	0,1 - 0,5 MPa
Presiune de verificare:	1,6 MPa (1 MPa = 10 bar = 147 PSI)
Temperatura apei calde:	max. 70°C
Temperatura recomandată a apei calde:	65°C
Racorduri:	G1/2 & G3/4
Debit de apă la 0,3 MPa:	
10750180 (1 Consumator)	44 l/min
10750180 (2 Consumator)	55 l/min
10650180	25 l/min
10971180	55 l/min
28486180	50 l/min
Dezinfecție termică:	max. 70°C / 4 min

Produsul este destinat exclusiv pentru apă potabilă.
Asigurat contra scurgere înapoi

DESCRIEREA SIMBOLURILOR

 Nu utilizați silicon cu conținut de acid acetic!

 DIMENSIUNI (vezi pag. 31)

 EXEMPLE DE MONTARE (vezi pag. 32)

Adaptați poziția modulelor condițiilor constructive.

 PIESE DE SCHIMB (vezi pag. 57)

 ELECTRICIAN

 ÎNTREȚINERE

Supapele antiretur trebuie verificate regulat conform DIN EN 1717 și standardele naționale sau regionale (cel puțin o dată pe an).

 Racord de apă DN20

Apă caldă

 Racord de apă DN20

Apă rece

 ÎN MIJLOCUL CĂZII DE DUȘ

 SE INTRODUCĂ APA / OPRIȚI
ALIMENTAREA CU APĂ

 TUB GOL EN 20

 PURTAȚI MĂNUȘI DE PROTECȚIE

 CURENT PORNIT / OPRIT

ORDINE DE MONTARE

 ASTUPAȚI ORIFICIILE DE EVA-
CUARE

Racordurile neutilizate trebuie acoperite cu dop etanș.

 ÎNĂLȚIMEA DE SARCINĂ A
CONDUCTEI

Montați conductele de apă înclinate (în cădere) pentru dușurile laterale.

PE EGALIZARE DE POTENȚIAL

N FIR NEUTRU

L CONDUCTOR

FI ÎNTRERUPĂTOR DE PROTECȚIE
FI

 ÎNTRERUPĂTOR DE LUMINĂ

 TRANSFORMATOR

 LUMINĂ

 CONEXIUNI

 AMPLIFICATOR PENTRU MI-
CROFON

 ESTE NEVOIE DE CONSOLIDA-
REA PEREȚII.

În această zonă este nevoie de întărirea peretelui.

 CERTIFICAT DE TESTARE (vezi pag. 57)

MONTARE (vezi pag. 52) 

ΥΠΟΔΕΙΞΕΙΣ ΑΣΦΑΛΕΙΑΣ

- ⚠ Για να αποφύγετε τραυματισμούς κατά τη συναρμολόγηση πρέπει να φοράτε γάντια.
- ⚠ Το προϊόν επιτρέπεται να χρησιμοποιείται μόνο σαν μέσο λουτρού, υγιεινής και καθαρισμού του σώματος.
- ⚠ Παιδιά ή ενήλικες με μειωμένες σωματικές, διανοητικές και/ή αισθητήριες ανεπάρκειες δεν επιτρέπεται να χρησιμοποιούν το προϊόν χωρίς επιτήρηση. Άτομα υπό την επίρρεια οινοπνεύματος ή ναρκωτικών δεν επιτρέπεται να χρησιμοποιούν σε καμία περίπτωση το προϊόν.
- ⚠ Η επαφή δέσμης νερού του ντους με ευαίσθητες περιοχές του σώματος (π.χ. μάτια) πρέπει να αποφεύγεται. Διατηρείτε επαρκή απόσταση ανάμεσα στο ντους και το σώμα.
- ⚠ Οι διαφορές της πίεσης μεταξύ της σύνδεσης κρύου και ζεστού νερού θα πρέπει να αντισταθμίζονται.

ΗΛΕΚΤΡΙΚΗ ΠΑΡΟΧΗ

- ⚠ Η ηλεκτρική εγκατάσταση επιτρέπεται να πραγματοποιηθεί μόνο από εξειδικευμένο ηλεκτρολόγο!
- ⚠ Προεγκατάσταση παροχής ρεύματος 230V/N/PE/50Hz (Μήκος: 0,3 m).
- ⚠ Στην ηλεκτρική εγκατάσταση πρέπει να τηρούνται οι αντίστοιχες προδιαγραφές της εκάστοτε ένωσης ηλεκτρολόγων, της εκάστοτε χώρας και εταιρείας ηλεκτρικού ρεύματος στην εκάστοτε έγκυρη έκδοση

ΡΕΛΕ ΠΡΟΣΤΑΣΙΑΣ ΡΕΥΜΑΤΟΣ ΔΙΑΡΡΟΗΣ

- ⚠ Η ασφάλιση θα πρέπει να πραγματοποιείται μέσω διάταξης προστασίας ρεύματος διαρροής (RCD/FI) με παραμένον ρεύμα ≤ 30 mA.

ΗΛΕΚΤΡΟΛΟΓΟΣ ΕΓΚΑΤΑΣΤΑΣΗΣ

- ⚠ Οι εργασίες εγκατάστασης και ελέγχου πρέπει να διενεργούνται από έναν εγκεκριμένο ηλεκτρολόγο, λαμβάνοντας υπόψη τις οδηγίες VDE 0100 Μέρος 701 και IEC 60364-7-701.

ΟΔΗΓΙΕΣ ΣΥΝΑΡΜΟΛΟΓΗΣΗΣ









- / Πριν τη συναρμολόγηση πρέπει να εξεταστεί το προϊόν για ζημιές μεταφοράς. Μετά την εγκατάσταση δεν αναγνωρίζονται ζημιές από τη μεταφορά ή επιφανειακές ζημιές.
- / Οι σωλήνες και η μπαταρία πρέπει να τοποθετηθούν σύμφωνα με τα ισχύοντα πρότυπα, να τεθούν υπό πίεση και να δοκιμαστούν.
- / Θα πρέπει να τηρούνται οι οδηγίες εγκατάστασης που ισχύουν σε κάθε κράτος.
- / Κατά τη συναρμολόγηση του προϊόντος από ειδικό προσωπικό θα πρέπει να ελέγχεται με ιδιαίτερη προσοχή η επιφάνεια στερέωσης, αν είναι επίπεδη σε όλη της την επιφάνεια (δεν πρέπει να εξέχουν αρμοί ή πλακάκια), αν η υποδομή του τοίχου είναι κατάλληλη για τη στερέωση του προϊόντος και αν παρουσιάζει ασθενή σημεία.
- / Προσοχή όταν τρυπάτε πάνω από σωλήνες ηλεκτρικού ή νερού!
- / Η κατανάλωση νερού πρέπει να έχει επαρκείς διαστάσεις.









ΤΕΧΝΙΚΑ ΧΑΡΑΚΤΗΡΙΣΤΙΚΑ

Λειτουργία πίεσης:	έως 1 MPa
Συνιστώμενη λειτουργία πίεσης:	0,1 - 0,5 MPa
Πίεση ελέγχου:	1,6 MPa (1 MPa = 10 bar = 147 PSI)
Θερμοκρασία ζεστού νερού:	έως 70°C
Συνιστώμενη θερμοκρασία ζεστού νερού:	65°C
Συνδέσεις:	G1/2 & G3/4
Κατανάλωση νερού στα 0,3 MPa:	
10750180 (1 Κατανάλωση)	44 l/min
10750180 (2 Κατανάλωση)	55 l/min
10650180	25 l/min
10971180	55 l/min
28486180	50 l/min
Θερμική απολύμανση:	έως 70°C / 4 min

Το προϊόν έχει σχεδιαστεί αποκλειστικά για πόσιμο νερό!
Περιλαμβάνει βαλβίδα αντεπιστροφής.

ΠΕΡΙΓΡΑΦΗ ΣΥΜΒΟΛΩΝ

-  Μην χρησιμοποιείτε σιλικόνη που περιέχει οξικό οξύ!
-  ΔΙΑΣΤΑΣΕΙΣ (βλ. Σελίδα 31)
-  ΠΑΡΑΔΕΙΓΜΑΤΑ ΣΥΝΑΡΜΟΛΟΓΗΣΗΣ (βλ. Σελίδα 32)
Προσαρμόστε τη διάταξη των στοιχείων στις επιτόπου συνθήκες
-  ΑΝΤΑΛΛΑΚΤΙΚΑ (βλ. Σελίδα 57)
-  ΗΛΕΚΤΡΟΛΟΓΟΣ ΕΓΚΑΤΑΣΤΑΣΗΣ
-  ΣΥΝΤΗΡΗΣΗ
Οι βαλβίδες αντεπιστροφής πρέπει να ελέγχονται τακτικά ως προς τη λειτουργία τους, σύμφωνα με το πρότυπο DIN EN 1717, σε σχέση με τους ισχύοντες εθνικούς ή τοπικούς κανόνες (το ελάχιστο μια φορά το χρόνο).
-  Παροχή νερού DN20
-  Ζεστό νερό
-  Παροχή νερού DN20
Κρύο νερό

-  ΜΕΣΟΝ ΤΗΣ ΝΤΟΥΣΙΕΡΑΣ
-  ΑΝΟΙΞΤΕ ΤΗΝ ΠΑΡΟΧΗ ΤΟΥ ΝΕΡΟΥ / ΚΛΕΙΣΤΕ ΤΗΝ ΠΑΡΟΧΗ ΝΕΡΟΥ
-  ΚΕΝΟΣ ΣΩΛΗΝΑΣ EN20
-  ΦΟΡΑΤΕ ΓΑΝΤΙΑ ΠΡΟΣΤΑΣΙΑΣ ΧΕΡΙΩΝ
-  ΡΕΥΜΑ ΟΝ / OFF
-  ΣΕΙΡΑ ΕΡΓΑΣΙΩΝ ΣΥΝΑΡΜΟΛΟΓΗΣΗΣ
-  ΤΑΠΩΣΤΕ ΤΙΣ ΑΠΟΡΡΟΕΣ
Τα περιττά στόμια εξόδου πρέπει να στεγανοποιηθούν με ένα τυφλό πώμα.
-  ΚΛΙΣΗ ΣΩΛΗΝΑ
Εγκαταστήστε τους αγωγούς νερού του καταιονιστήρα σώματος με κλίση.

-  ΠΕ ΕΞΙΣΩΣΗ ΔΥΝΑΜΙΚΟΥ
-  Ν ΟΥΔΕΤΕΡΟΣ
-  Λ ΑΓΩΓΟΣ
-  FI ΔΙΑΚΟΠΤΗΣ ΠΡΟΣΤΑΣΙΑΣ FI
-  ΔΙΑΚΟΠΤΗΣ ΦΩΤΙΣΜΟΥ
-  Τ ΤΡΑΦΟ (μετασχηματιστής)
-  ΦΩΤΙΣΤΙΚΟ
-  ΗΛΕΚΤΡΙΚΟΙ ΣΥΝΔΕΤΗΡΕΣ
-  ΕΝΙΣΧΥΤΗΣ ΓΙΑ ΜΕΓΑΦΩΝΟ
-  ΑΠΑΡΑΙΤΗΤΗ ΕΝΙΣΧΥΣΗ ΤΟΙΧΟΥ
Σε αυτήν την περιοχή είναι απαραίτητη μία ενίσχυση του τοίχου.
-  ΣΗΜΑ ΕΛΕΓΧΟΥ (βλ. Σελίδα 57)



VARNOSTNA OPOZORILA

- ⚠ Pri montaži je treba nositi rokavice, da se preprečijo poškodbe zaradi zmečkanja ali urezov.
- ⚠ Ta izdelek se sme uporabljati le z namenom umivanja, vzdrževanja higiene in telesne nege.
- ⚠ Otroci kot tudi odrasle osebe z omejenimi telesnimi, duševnimi in/ali senzoričnimi sposobnostmi ne smejo nenadzorovano uporabljati tega izdelka. Osebe, ki so pod vplivom alkohola ali drog, tega izdelka ne smejo uporabljati.
- ⚠ Izogibati se je treba stiku prhalnega curka z občutljivimi deli telesa (npr. očmi). Med telesom in prho mora biti vedno zadosten razmik.
- ⚠ Velike razlike v tlaku med priključkom za mrzlo in priključkom za toplo vodo je potrebno izravnati.

ELEKTRIČNI PRIKLJUČEK

- ⚠ Električno priključitev sme izvesti le elektrostrokovnjak!
- ⚠ Najprej instalirajte oskrbo s tokom 230V/N/PE/50Hz (dolžina: 0,3 m).
- ⚠ Pri električni instalaciji je treba upoštevati ustrezne VDE, nacionalne in EVU predpise v aktualno veljavni izdaji.

ZAŠČITA PRED OKVARNIM TOKOM

- ⚠ Zaščita se mora izvesti preko zaščitnega tokovnega stikala (RCD/FI) z izračunanim diferencialnim tokom ≤ 30 mA.

ELEKTROINŠTALATER

- ⚠ Instalacijo in preizkuse mora izvesti pooblaščen elektro strokovnjak, pri čemer mora upoštevati VDE 0100 Del 701 in IEC 60364-7-701.

NAVODILA ZA MONTAŽO

- / Pred montažo je treba izdelek preveriti glede morebitnih transportnih poškodb. Po vgrajni transportne ali površinske poškodbe ne bodo več priznane.
- / Cevi in armaturo je treba montirati, izprati in preveriti po veljavnih standardih.
- / Upoštevati je treba pravilnike o inštalacijah, ki veljajo v posamezni državi.
- / Pri montaži tega proizvoda s strani kvalificiranega strokovnega osebja je treba paziti na to, da je pritrdilna ploskev na celotni površini za pritrditev gladka (brez izstopajočih fug ali zasekov ploščic), da je struktura stene primerna za montažo proizvoda in ne kaže šibkih mest.
- / Pri vrtnanju bodite pozorni na električne vodnike in vodovodno napeljavo
- / Zmogljivost odtoka mora biti ustrezne velikosti.

TEHNIČNI PODATKI

Delovni tlak:	maks. 1 MPa
Priporočeni delovni tlak:	0,1 - 0,5 MPa
Preskusni tlak:	1,6 MPa (1 MPa = 10 bar = 147 PSI)
Temperatura tople vode:	maks. 70°C
Priporočena temperatura tople vode:	65°C
Priključki:	G1/2 & G3/4
Pretok vode pri 0,3 MPa:	
10750180 (1 Porabnik)	44 l/min
10750180 (2 Porabnik)	55 l/min
10650180	25 l/min
10971180	55 l/min
28486180	50 l/min
Termična dezinfekcija:	maks. 70°C / 4 min

Proizvod je zasnovan izključno za sanitarno vodo!
Zaščita proti povratnemu toku

OPIS SIMBOLA

 Ne smete uporabiti silikona, ki vsebuje ocatno kislino!

 MERE (glejte stran 31)

 PRIMERI MONTAŽE (glejte stran 32)

Razporeditev modulov priagodite gradbenim okoliščinam.

 REZERVNI DELI (glejte stran 57)

 ELEKTROINŠTALATER

 VZDRŽEVANJE

Delovanje protipovratnega ventila je potrebno v skladu z DIN EN 1717 in skladno z državnimi in regionalnimi določili redno testirati (najmanj enkrat letno).

 Vodni priključek DN20

Topla voda

 Vodni priključek DN20

Mrzla voda

 SREDINA PRŠNE KADI

 ODPRITE VODO / ZAPRITE VODO.

 PRAZNA CEV EN20

 NOSITE ZAŠČITNE ROKAVICE

 TOK VKLOP / IZKLOP

MONTAŽNO ZAPOREDJE

 ODMAŠITEV ODVODOV
Izhod, ki ga ne potrebujete, zatesnite s čepom.

 NAGIB VODOVODA
Položite vodovodne cevi za stranske šobe z naklonom.

 PE POTENCIALNA IZENAČITEV

 N NIČELNI VODNIK

 L VODNIK

 FI ZAŠČITNO TOKOVNO STIKALO

 STIKALO ZA LUČ

 TRAFI

 SVETILO

 VTIČNE POVEZAVE

 OJAČEVALNIK ZA ZVOČNIKE

 POTREBNO JE OJAČANJE STENE

V tem območju je potrebno ojačanje stene.

 PRESKUSNI ZNAK (glejte stran 57)

MONTAŽA (glejte stran 52) 

OHUTUSJUHISED

- ⚠ Kandke paigaldamisel muljumis- ja löikevigastuste vältimiseks kindaid.
- ⚠ Toodet tohib kasutada ainult pesemis-, hügieeni- ja kehapuhastamisesmärkidel.
- ⚠ Lapsed, samuti kehaliste, vaimsete või tajupiirangutega täiskasvanud ei tohi dušisüsteemi järelevalveta kasutada. Alkoholi või narkootikumide mõju all olevad isikud ei tohi dušisüsteemi kasutada.
- ⚠ Duši veejoad ei tohi kokku puutuda tundlike kehaosadega (nt silmad). Jätke duši ja keha vahele piisav vahe.
- ⚠ Kui külma ja kuumu vee ühenduste surve on väga erinev, tuleb need tasakaalustada.

ELEKTRIÜHENDUS

- ⚠ Elektriyhenduse peab läbi viima väljaõppinud elektrik!
- ⚠ Eelinstalleerige toide 230V/N/PE/50Hz (pikkus: 0,3 m).
- ⚠ Elektriiinstallatsiooni juures tuleb järgida vastavaid Saksa elektrotehnikute liidu VDE, riiklikke ja energiafirma eeskirju nende kehtivas versioonis.

RIKKEVOOLU KAITSESEADIS

- ⚠ Kaitse peab toimuma rikkevoolu kaitseeadisega (RCD/FI) nominaal-jääkvooluga ≤ 30 mA.

ELEKTRIMONTÖÖR

- ⚠ Paigaldustööd ja kontroll laske viia läbi sertifitseeritud spetsialistil vastavalt VDE 0100 osa 701 ja IEC 60364-7:701 eeskirjadele.

PAIGALDAMISJUHISED

- / Enne paigaldamist tuleb toodet kontrollida transpordikahjustuste osas Pärast paigaldamist ei tunnustata enam transpordi- või pinnakahjustuste kaebuseid.
- / Voolikute ja segisti paigaldamisel, loputamisel ja kontrollimisel tuleb lähtuda kehtivatest normatiividest
- / Vastavas riigis kehtivaid paigalduseeskirju tuleb järgida.
- / Toote paigaldamisel kvalifitseeritud spetsialistide poolt tuleb jälgida, et kinnituspind oleks kogu ulatuses ühtlaselt tasane (mitte ühtki üleseisvat vuuki või kaldus kahhelkivi), seina ülesehitus toote paigaldamiseks sobiv ja ilma nõrkade kohtadeta.
- / Arvestage puurimisel voolukaablite ja veejuhtmete asukohaga
- / Äravoolu jõudlus peab olema piisav.

TEHNILISED ANDMED

Töörõhk	maks. 1 MPa
Soovitatav töörõhk:	0,1 - 0,5 MPa
Kontrollsurve:	1,6 MPa (1 MPa = 10 baari = 147 PSI)
Kuumu vee temperatuur:	maks. 70°C
Soovitatav kuumu vee temperatuur:	65°C
ühendused:	G1/2 & G3/4
Läbivool, kui rõhk on 0,3 MPa:	
10750180 (1 Tarbija)	44 l/min
10750180 (2 Tarbija)	55 l/min
10650180	25 l/min
10971180	55 l/min
28486180	50 l/min
Termiline desinfektsioon:	maks. 70°C / 4 min

Toode on ette nähtud eranditult joogivee jaoks!
Tagasivooluklapp

SÜMBOLITE KIRJELDUS

	Ärge kasutage äädikhapet sisaldavat silikoonil		DUŠIVANNI KESE		POTENTSIAALI TASAKAALUSTAMINE
	MÕÖTUDE (vt lk 31)		KEERAKE VESI LAHTI / KEERAKE VESI KINNI		NEUTRAALJUHE
	PAIGALDUSE NÄITED (vt lk 32) Kohandage moodulite asendit paigaldusoludega sobivaks.		PAIGALDUSTORU EN20		JUHE
	VARUOSAD (vt lk 57)		KANDKE KAITSEKINDAID		KAITSE
	ELEKTRIMONTÖÖR		ELEKTRIVOOL SEES / VÄLJAS		VALGUSLÜLITI
	HOOLDUS Tagasilöögiklappide toimimist tuleb kooskõlas riiklike ja regionaalsete määrustega regulaarselt kontrollida vastavalt standardile DIN EN 1717 (vähemalt kord aastas).		MONTAAŽIJÄRJESTUS		TRANSFORMAATOR
			SULGEGE ÄRAVOOLUAVAD Mittevajalik väljavool tuleb sulgeda korgiga.		VALGUSTI
			TORUSTIKU LANGUS Paigaldage kehaduši jaoks vajalikud veetorud kaldega.		PISTIKÜHENDUSED
	Veeühendus DN20				KÖLARITE VÕIMENDI
	Soe vesi				VAJALIK SEINATUGEVDUS Selles alas tuleb seina tugevdada.
	Veeühendus DN20				KONTROLLSERTIFIKAAT (vt lk 57)
	Külm vesi				

DROŠĪBAS NORĀDES

- ⚠ Montāžas laikā, lai izvairītos no saspiedumiem un iegriezumiem, nepieciešams nēsāt cimdus.
- ⚠ Šo produktu drīkst izmantot tikai, lai mazgātos, higiēnai un ķermeņa tīrīšanai.
- ⚠ Bērni, kā arī pieaugušie ar fiziskiem, garīgiem un/vai sensoriskiem ierobežojumiem nedrīkst lietot šo produktu bez uzraudzības. Personas, kas atrodas alkohola vai narkotisko vielu iespaidā, nedrīkst lietot šo dušas sistēmu.
- ⚠ Nepieciešams izvairīties no dušas strūkļas tieša kontakta ar jutīgām ķermeņa daļām (piem., acīm). Nepieciešams ievērot pietiekošu attālumu starp dušu un ķermeni.
- ⚠ Jāizlīdzina spiediena atšķirības starp aukstā un karstā ūdens pievadiem.

ELEKTROAPGĀDES PIESLĒGVIETA

- ⚠ Elektrisko pieslēgumu drīkst veikt tikai elektriķis!
- ⚠ Iepriekš instalējiet elektroapgādi 230V/N/PE/50Hz (garums: 0,3 m).
- ⚠ Izveidojot elektroinstalāciju, jāņem vērā attiecīgjie VDE (Vācijas elektrotehnikas savienības), valsts un energoapgādes uzņēmumu noteikumi attiecīgi spēkā esošajā redakcijā.

DROŠINĀTĀJS

- ⚠ Jānodrošina noplūdes strāvas aizsargsistēma (RCD/FI) ar izmērīto strāvas starpību ≤ 30 mA.

ELEKTROMONTIERIS

- ⚠ Instalācijas un pārbaudes darbus jāveic sertificētam speciālistam saskaņā ar DIN VDE 0100 701. d. un IEC 60364-7-701.

NORĀDĪJUMI MONTĀŽAI

- / Pirms montāžas nepieciešams pārbaudīt, vai produktam transportēšanas laikā nav radušies bojājumi. Pēc iebūvēšanas bojājumi, kas radušies transportēšanas laikā, vai virsmas bojājumi netiek atzīti.
- / Caurulvadi un armatūra ir jāuzstāda, jāizskalo un jāpārbauda saskaņā ar spēkā esošajiem standartiem.
- / Jāievēro attiecīgās valstīs spēkā esošās montāžas prasības.
- / Kvalificētiem speciālistiem, montējot produktu, jāpiegriež vērība tam, lai piestiprināšanas virsma visā piestiprināšanas zonā ir gluda (nav fūgu vai fližu iecirtumu), sienas uzbūve ir piemērota produkta montāžai un tajā nav nestabilu vietu.
- / Urbjot pievērsiet uzmanību elektrības un ūdens vadiem!
- / Noplūdei jānodrošina pietiekama ūdens caurplūde.

TEHNISKIE DATI

Darba spiediens:	maks. 1 MPa
Ieteicamais darba spiediens:	0,1 - 0,5 MPa
Pārbaudes spiediens:	1,6 MPa (1 MPa = 10 bar = 147 PSI)
Karstā ūdens temperatūra:	maks. 70°C
Ieteicamā karstā ūdens temperatūra:	65°C
Pieslēgumi:	G1/2 & G3/4
Caurteces intensitāte pie 0,3 MPa:	
10750180 (1 Patērētājs)	44 l/min
10750180 (2 Patērētājs)	55 l/min
10650180	25 l/min
10971180	55 l/min
28486180	50 l/min
Termiskā dezinfekcija :	maks. 70°C / 4 min

Izstrādājums ir paredzēts tikai dzeramajam ūdenim!
Drošības vārsts

SIMBOLU NOZĪME

	Neizmantot silikonu, kas satur etiķskābi!		DUŠAS PALIKTŅA VIDUS		POTENCIĀLA IZLĪDZINĀŠANA
	IZMĒRUS (skat. lpp. 31)		ATGRIEZIET ŪDENI / NOSLĒGT ŪDENI		NULLES VADS
	MONTĀŽAS PIEMĒRI (skat. lpp. 32) Moduļu izkārtojumu pielāgojiet ēkas apstākļiem.		TUKŠA CAURULE EN20		VADS
	REZERVES DAĻAS (skat. lpp. 57)		VALKĀT AIZSARGCIMDUS		DROŠINĀTĀJS
	ELEKTROMONTIERIS		STRĀVA IESLĒGTA / IZSLĒGTA		GAISMAS SLĒDZIS
	APKOPE Regulāri jāpārbauda pretvārsta funkcija saskaņā ar DIN EN 1717 saistībā ar nacionālajiem vai vietējiem noteikumiem (vismaz vienreiz gadā).		MONTĀŽAS SECĪBA		TRANSFORMATORS
	Ūdensvada pieslēgvietā DN20 Siltais ūdens		NOSLĒDZIET ATVERES Neizmantoto izteku aizbāzīt ar aizbāzni.		APGAISMES ĶERMENIS
	Ūdensvada pieslēgvietā DN20 Aukstais ūdens		CAURULES KRITUMS Montēt ūdens caurulvadu sānu (ķermeņa) dušām ar atbilstošu slīpumu.		SPRAUDKONTAKTI
					PASTIPRINĀTĀJS SKAĻRUNIM
					NEPIECIEŠAMA SIENAS STIPRINĀŠANA Šajā zonā ir nepieciešams pastiprināt sienu.
					PĀRBAUDES ZĪME (skat. lpp. 57)

SIGURNOSNE NAPOMENE

- ⚠ Prilikom montaže se radi sprečavanja prignječanja i posekotina moraju nositi rukavice.
- ⚠ Proizvod sme da se koristi samo za kupanje, tuširanje i ličnu higijenu.
- ⚠ Deca, kao i telesno, mentalno i/ili senzorno hendikepirane odrasle osobe ne smeju da koriste proizvod bez nadzora. Osobe koje su pod uticajem alkohola ili droga ne smeju da koriste proizvod.
- ⚠ Mora se izbegavati kontakt mlaza iz tuša sa osetljivim delovima tela (npr. očima). Telo korisnika mora biti na dovoljnom odstojanju od tuša.
- ⚠ Velika razlika u pritisku između vruće i hladne vode mora biti izbalansirana.

ELEKTRIČNI PRIKLJUČAK

- ⚠ Električku sme priključiti samo ovlašćeni električar!
- ⚠ Prethodno instalirajte električno napajanje 230V/N/PE/50Hz (dužina: 0,3 m).
- ⚠ Prilikom izvođenja električnih instalacionih radova treba se pridržavati odgovarajućih, trenutno važećih propisa stručnog udruženja elektrotehničara (u Nemačkoj: VDE), državnih propisa kao i propisa lokalne elektro-distribucije.

NADSTRUJNA ZAŠTITNA SKLOPKA

- ⚠ Vod se mora osigurati nadstrujnom zaštitnom sklopkom (RCD/FI) s nazivnom diferencijalnom strujom ≤ 30 mA.

ELEKTROINSTALATER

- ⚠ Instalaciju i ispitivanje smeju obavljati isključivo sertifikovani električari uz uvažavanje odredaba VDE 0100 deo 701 i IEC 60364-7-701.

INSTRUKCIJE ZA MONTAŽU

- / Pre montaže se mora proveriti da li je proizvod oštećen pri transportu. Nakon ugradnje se ne priznaju nikakve reklamacije koje se odnose na površinska i transportna oštećenja.
- / Vodovi i armatura moraju biti postavljeni, isprani i testirani prema važećim normama.
- / Treba se pridržavati propisa koji u određenim zemljama važe za instalacije.
- / Kada proizvod montira kvalifikovano stručno osoblje treba paziti da čitava površina na koju se učvršćuje bude ravna (bez istaknutih fuga ili krivljenja pločica), da je zidna konstrukcija primerena montaži proizvoda i da nema slabih mesta.
- / Prilikom bušenja treba paziti na električne kablove i vodovodne cevi!
- / Mora se predvideti dovoljan kapacitet odvoda.

TEHNIČKI PODACI

Radni pritisak:	maks. 1 MPa
Preporučeni radni pritisak:	0,1 - 0,5 MPa
Probni pritisak:	1,6 MPa
	(1 MPa = 10 bar = 147 PSI)
Temperatura vruće vode:	maks. 70°C
Preporučena temperatura vruće vode:	65°C
Priključci:	G1/2 & G3/4
Protok vode pri pritisku od 0,3 MPa:	
10750180 (1 Potrošač)	44 l/min
10750180 (2 Potrošač)	55 l/min
10650180	25 l/min
10971180	55 l/min
28486180	50 l/min
Termička dezinfekcija:	maks. 70°C / 4 min

Proizvod je koncipiran isključivo za pijaću vodu!
Zaštita od povratnog toka

OPIS SIMBOLA

 Nemojte koristiti silikon koji sadrži sirćetnu kiselinu!

 MERE (vidi stranu 31)

 PRIMERI MONTAŽE (vidi stranu 32)
Raspored modula prilagodite građevinskim uslovima na mestu postavljanja.

 REZERVNI DELOVI (vidi stranu 57)

 ELEKTROINSTALATER

 ODRŽAVANJE
Ispravno funkcionisanje nepovratnog ventila se mora redovno proveravati prema standardu DIN EN 1717 i u skladu s važećim nacionalnim ili regionalnim propisima (najmanje jednom godišnje).

 priključak za vodu DN20
Topla voda

 priključak za vodu DN20
Hladna voda

 X SREDINA TUŠ-KADA

 OTVORITE DOTOK VODE / ZATVORITE DOTOK VODE

 ŠUPLJA CEV EN20

 NOSITE ZAŠTITNE RUKAVICE

 STRUJA UKLJ. / ISKLJ.

 1. REDOSLED MONTAŽNIH RADOVA

 ODČEPLJIVANJE ODVODA
Izlaz koji se ne koristi, mora se zatvoriti slepim čepom.

 % NAGIB CEVI
Položite vodovodne cevi za bočni tuš s nagibom.

PE IZJEDNAČENJE POTENCIJALA

N NULLI PROVODNIK

L PROVODNIK

FI FI-SKLOPKA

 PREKIDAČ ZA SVETLO

 TRANSFORMATOR

 SVETILJKA

 UTIČNI SPOJEVI

 POJAČALO ZA ZVUČNIK

 NEOPHODNO OJAČANJE ZIDA
U ovoj oblasti je potrebno ojačanje zida.

 ISPITNI ZNAK (vidi stranu 57)

MONTAŽA (vidi stranu 52) 

SIKKERHETSHENVISNINGER

- ⚠ Bruk hansker under montasjen for å unngå klem- og kuttskader.
- ⚠ Produktet skal kun brukes for bade-, hygiene- og kroppshygiene.
- ⚠ Barn og voksne med fysiske og psykiske og/eller sensoriske handicap skal ikke bruke dusjsystemet uten oppsyn. Personer som er påvirket av alkohol eller narkotika skal ikke bruke dusjsystemet.
- ⚠ Dusjstrålen skal ikke komme i kontakt med ømfintlige kroppsdeler (f.eks. øynene). Overhold en tilstrekkelig avstand mellom dusjen og kroppen.
- ⚠ Store trykkdifferanser mellom kaldt- og varmtvannstilkoblinger skal utlignes.

EL-TILKOBLINGER

- ⚠ El-tilkoblinger skal kun utføres av el-fagfolk!
- ⚠ Strømforsyning 230V/N/PE/Hz (lengde: 0,3 m) installeres på forhånd.
- ⚠ Ved el-installasjonen skal de tilsvarende gyldige VDE-, nasjonale og EVU-forskrifter overholdes.

LEKKSTRØM VERNE-INNRETNING

- ⚠ Installasjonen skal sikres ved hjelp av en jordfeilbryter (RCD/FI) dimensjonert for en reststrøm på ≤ 30 mA.

EL-INSTALLATØR

- ⚠ Installasjons- og kontrollarbeid skal utføres av en godkjent el-fagbedrift som overholder direktiv VDE 0100 del 701 og IEC 60364-7-70101.

MONTAGEHENVISNINGER

- / Før montasjen skal produktet sjekkes for transportskader. Etter monteringen aksepteres ikke noen transport- eller overflateskader.
- / Ledningene og armaturen skal monteres, spyles og sjekkes iht. de gyldige normer.
- / Gjeldende retningslinjer for rørleggerarbeid i de enkelte land skal følges.
- / Under monteringen av produktet gjort av kvalifisert fagperson, skal man påse at monteringsoverflaten på hele festeområdet er plant (ingen utstikkende fuger eller flisekanter), at veggoppbyggingen egner seg for produktmontasjen og ikke viser svake punkter.
- / Ved boring skal det passes på strøm- og vannledninger!
- / Utløpsytelsen skal være tilstrekkelig dimensjonert.

TEKNISKE DATA

Driftstrykk	maks. 1 MPa
Anbefalt driftstrykk:	0,1 - 0,5 MPa
Prøvetrykk	1,6 MPa
	(1 MPa = 10 bar = 147 PSI)
Varmtvannstemperatur	maks. 70°C
Anbefalt temperatur for varmt vann	65°C
Tilkoblinger:	G1/2 & G3/4
Gjennomstrømningsytelse ved 0,3 MPa:	
10750180 (1 Forbruker)	44 l/min
10750180 (2 Forbruker)	55 l/min
10650180	25 l/min
10971180	55 l/min
28486180	50 l/min
Termisk desinfisering:	maks. 70°C / 4 min

Produktet er utelukkende designet for drikkevann!
Egensikker mot tilbakeflyt

SYMBOLBESKRIVELSE

 Ikke bruk silikon som inneholder eddiksyre!

 MÅL (se side 31)

 MONTASJE-EKSEMPEL (se side 32)
Modulenes anordning tilpasses omstendighetene

 SERVICEDELER (se side 57)

 EL-INSTALLATØR

 VEDLIKEHOLD
Funksjonen til returløpssperren skal iht. DIN EN 1717 og i samsvar med de nasjonale og lokale forskrifter sjekkes regelmessig (DIN 1988 en gang i året).

 Vanntilkobling DN20
Varmtvann

 Vanntilkobling DN20
Kaldtvann

 MIDTEN PÅ DUSJKAR

 VANN SETTES PÅ / SLÅ AV
VANN

 TOMRØR EN20

 BRUK VERNEHANSKER

 STRØM PÅ / AV

MONTASJE REKKEFØLGE

 STOPPE TIL AVGANGER
Utgangen som ikke brukes kan tettes med en blindplugg.

 LEDNINGSFALL
Vannledninger for sidedusjer installeres med fall.

PE POTENSIALUTJEVNING

N NULLEDER

L LEDER

FI FI-VERNEBRYTER

 LYSBRYTER

 TRANSFORMATOR

 LYSMIDDEL

 PLUGGFORBINDELSE

 FORSTERKER FOR HØYTALER

 VEGGFORSTERKNING ER NØDVENDIG
I dette området skal veggen forsterkes.

 PRØVEMERKE (se side 57)

УКАЗАНИЯ ЗА БЕЗОПАСНОСТ

- ⚠ При монтажа трябва да се носят ръкавици, за да се избегнат наранявания поради притискане или порязване.
- ⚠ Позволено е използването на продукта само за къпане, хигиена и цели на почистване на тялото.
- ⚠ Не е позволено деца, както и възрастни с физически, умствени и/или сензорни ограничения да използват продукта без надзор. Не е позволено използването на системата на продукта от лица, употребили алкохол или дрога.
- ⚠ Трябва да се избягва контакта на струите на разпръсквателя с чувствителни части на тялото (напр. очите). Между разпръсквателя и тялото трябва да се спазва достатъчно разстояние.
- ⚠ Големите разлики в налягането между изводите за студената и топлата вода трябва да се изравняват.

СВЪРЗВАНЕ КЪМ ЕЛЕКТРИЧЕСТВОТО

- ⚠ Свързването към електричество се позволява само от електротехник!
- ⚠ Захранване с ток 230V/N/PE/50Hz (дължина: 0,3 м).
- ⚠ При електроинсталацията трябва да се спазват съответните разпоредби на VDE (Съюз на електротехниците в Германия), на страната и на EVU (Съюз на електроснабдителните предприятия) в съответно валидната им редакция.

ПРЕДПАЗЕН ШАЛТЕР ЗА ОСТАТЪЧЕН ТОК

- ⚠ Защитата трябва да се осъществи с предпазен шалтер за остатъчен ток (RCD/FI) с параметриран диференциален ток ≤ 30 mA.

ЕЛЕКТРОМОНТЪОР

- ⚠ Дейностите по инсталацията и инспекцията следва да бъдат изпълнявани от оторизиран електротехник при спазване на VDE 0100 Част 701 и IEC 60364-7-701.

УКАЗАНИЯ ЗА МОНТАЖ









- / Преди монтажа продуктът трябва да се провери за транспортни щети. След монтажа не се признават транспортни или повърхностни щети.
- / Тръбопроводите и арматурата трябва да се монтират, промият и проверят в съответствие с валидните норми.
- / Трябва да бъдат спазвани валидните в съответните страни предписания за инсталиране.
- / При монтаж на продукта от квалифицирани специалисти да се внимава за това, закрепващата повърхност в целия диапазон на закрепването да бъде равна (без изпъкнали fugи или изместване на плочки), конструкцията на стената да е подходяща за монтаж на продукта и да няма слаби места.
- / При пробиването внимавайте за електро- и водопроводите!
- / Трябва да се изчисли достатъчна мощност на изтичане.







ТЕХНИЧЕСКИ ДАННИ











Работно налягане:	макс. 1 МПа
Препоръчително работно налягане:	0,1 - 0,5 МПа
Контролно налягане:	1,6 МПа (1 МПа = 10 bar = 147 PSI)
Температура на горещата вода:	макс. 70°C
Препоръчителна температура на горещата вода:	65°C
Изводи:	G1/2 & G3/4
Мощност на потока при 0,3 МПа:	
10750180 (1 Консуматор)	44 л/мин
10750180 (2 Консуматор)	55 л/мин
10650180	25 л/мин
10971180	55 л/мин
28486180	50 л/мин
Термична дезинфекция:	макс. 70°C/4 мин

Продуктът е разработен само за питейна вода!
Самозащитен против обратно изтичане

ОПИСАНИЕ НА СИМВОЛИТЕ

-  Не използвайте силикон, съдържащ оцетна киселина!
-  РАЗМЕРИ (вижте стр. 31)
-  ПРИМЕРИ ЗА МОНТАЖ (вижте стр. 32)
Подреждането на модулите се изпълнява в съответствие с конструктивните дадености.
-  СЕРВИЗНИ ЧАСТИ (вижте стр. 57)
-  ЕЛЕКТРОМОНТЪОР
-  ПОДДРЪЖКА
Съгласно DIN EN 1717 функционирането на приспособленията за предотвратяване на обратния поток трябва редовно да се проверява в съответствие с националните или регионални изисквания (поне веднъж годишно).
-  Извод за вода DN20
Топла вода
-  Извод за вода DN20
Студена вода

-  СРЕДА НА КОРИТОТО НА ДУШ-КАБИНАТА
-  ВКЛЮЧВАНЕ НА ВОДАТА / ИЗКЛЮЧВАНЕ НА ВОДАТА
-  ТРЪБА ЗА ПОЛАГАНЕ НА КАБЕЛИ EN20
-  НОСЕТЕ ЗАЩИТНИ РЪКАВИЦИ
-  ЕЛЕКТРИЧЕСТВО ВКЛ / ИЗКЛ
-  ПОСЛЕДОВАТЕЛНОСТ НА МОНТАЖА
-  ЗАТАПВАНЕ НА ИЗВОДИТЕ
Излишният извод може да се уплътни с глуха пробка.
-  НАКЛОН НА ТРЪБОПРОВОДА
Водопроводните линии за страничните разпръскватели полагайте с наклон.

-  PE ИЗРАВНЯВАНЕ НА ПОТЕНЦИАЛА
-  N НУЛЕВ ПРОВОДНИК
-  L ПРОВОДНИК
-  FI ЗАЩИТЕН ПРЕКЪСВАЧ ПОГРЕШЕН ТОК
-  ПРЕКЪСВАЧ ЗА ОСВЕТЛЕНИЕТО
-  ТРАНСФОРМАТОР
-  ОСВЕТИТЕЛНО ТЯЛО
-  ЩЕПСЕЛНИ СЪЕДИНЕНИЯ
-  УСИЛВАТЕЛ ЗА ВИСОКОГОВОРИТЕЛ
-  НЕОБХОДИМО Е УСИЛВАНЕ НА СТЕНАТА
В тази област е необходимо подсилване на стената.
-  КОНТРОЛЕН ЗНАК (вижте стр. 57)

UDHËZIME SIGURIE

- ⚠ Për të evituar lëndimet e pickimeve ose të prerjeve gjatë procesit të montimit duhet që të vishni doreza.
- ⚠ Produkti duhet të përdoret vetëm qëllimet e banjave, të higjienës dhe të larjes së trupit.
- ⚠ Fëmijët dhe të rriturit me aftësi të kufizuara fizike, mendore dhe/ose ndijuese nuk duhet ta përdorin produktin pa qenë nën mbikëqyrje. Personat që janë nën ndikimin e drogave ose të alkoolit nuk duhet ta përdorin produktin.
- ⚠ Kontakti i valëve të dushit me pjesët e ndjeshme të trupit (p.sh. me sytë) duhet që të shmanget. Midis dushit dhe trupit duhet që të mbahet një distancë e mjaftueshme.
- ⚠ Ndryshimet e mëdha të presionit mes lidhjeve të ujit të ftohtë dhe atij të ngrohtë duhen ekuilibruar.

⚠ LIDHJA ME RRJETIN ELEKTRIK

- ⚠ Lidhjet elektrike mund të bëhen vetëm nga elektricisti i specializuar.
- ⚠ Instaloni paraprakisht ushqimin elektrik 230V/N/PE/50Hz (gjatësia 0,3 m).
- ⚠ Gjatë instalimit elektrik duhen respektuar normat përkatëse të VDE-së, të shtetit dhe të EVU-së në verzionin e tyre aktual

PAJISJA MBROJTËSE KUNDËR RRJEDHJES SË RRYMËS

- ⚠ Sigurimi duhet të kryhet nëpërmjet një pajisjeje mbrojtëse kundër rrjedhjes së rrymës (RCD/FI) me një vlerësim të rrymës diferenciale $\leq 30\text{mA}$.

⚠ ELEKTRICISTI

- ⚠ Punimet e instalimit dhe të kontrollit duhet të realizohen nga një electricist i autorizuar duke marrë parasysh VDE 0100 Pjesa 701 dhe standardin IEC 60364-7-701.

UDHËZIME PËR MONTIMIN

- / Përpara montimit duhet që produkti të kontrollohet për dëmtime nga transporti. Pas instalimit nuk do të njihet asnjë dëmtim nga transporti ose dëmtim i sipërfaqes.
- / Tubacionet dhe rubinetet duhet që të montohen, të shpëlahen dhe të kontrollohen sipas standardeve në fuqi
- / Duhet të respektohen linjat udhëzuese të instalimit, të vlefshme për vendet respektive.
- / Gjatë montimit të produktit nga teknikët e specializuar duhet mbajtur parasysh që sipërfaqja e montimit gjendet brenda zonës së përgjithshme të planit të montimit (nuk ka vendbashkime të dala ose mospërputhje të pllakave), që struktura e murit është e përshtatshme për montimin e produktit dhe që nuk paraqet asnjë pikë të dobët.
- / Gjatë shpimit bëni kujdes për të gjitha linjat elektrike dhe tubacionet e ujit!
- / Kapaciteti i rrjedhjes duhet dimensionuar në mënyrë të mjaftueshme.

TË DHËNA TEKNIKE

Presioni gjatë punës	maks. 1 MPa
Presioni i rekomanduar:	0,1 - 0,5 MPa
Presioni për provë:	1,6 MPa (1 MPa = 10 bar = 147 PSI)
Temperatura e ujit të ngrohtë	maks. 70°C
Temperatura e rekomanduar e ujit të ngrohtë:	65°C
Lidhjet:	G1/2 & G3/4
Kapaciteti i rrjedhjes në 0,3 MPa:	
10750180 (1 Konsumator)	44 l/min
10750180 (2 Konsumator)	55 l/min
10650180	25 l/min
10971180	55 l/min
28486180	50 l/min
Dezinfektim Termik:	maks. 70°C / 4 min

Produkti është projektuar ekskluzivisht për ujë të pijshëm!
Siguresa kundër rrjedhjes në drejtim të kundërt

PËRSHKRIMI I SIMBOLIT

 Mos përdorni silikon që në përbërje ka acid acetik.

 PËRMASAT (shih faqen 31)

 SHEMBUJ TË MONTIMIT (shih faqen 32)

Përshtateni vendosjen e modulit sipas kushteve të ndërtimit.

 PJESËT E SERVISIT (shih faqen 57)

 ELEKTRICISTI

 MIRËMBAJTJA

Penguesit e rrjedhjes në drejtim të kundërt duhen kontrolluar rregullisht në bazë të normave DIN EN 1717 konform normave nacionale dhe regjionale (së paku një herë në vit).

 Lidhja me rrjetin e ujit DN20
Uji i ngrohtë

 Lidhja me rrjetin e ujit DN20
Uji i ftohtë

 MESI I VASKËS SË DUSHIT

 HAPNI UJIN / MBYLLNI UJIN.

 TUBI I SHTRIMIT EN20

 VENDOSNI DOREZA MBROJTËSE

 KORRENTI KYÇUR / SHKYÇUR

 RADHA E MONTIMIT

 BLOKIMI I DALJEVE
Dalja që nuk nevojitet duhet izoluar me tapë qorre.

 PENDENCA E TUBACIONIT
Vendosni tubacionet e ujit për spërkatëset anësore me pjerrësi.

 PE BARAZIMI I POTENCIALEVE

 N LIDHJA NEUTRALE

 L LIDHJE

 FI ÇELËSI MBROJTËS FI

 ÇELËSI I DRITËS

 T TRAFU

 NDRIÇUESI

 LIDHJET E PRIZAVE

 PËRFORCUESI PËR ALTOPARLANTIN

 NEVOJITET PËRFORCIMI I MURIT

Në këtë zonë është i nevojshëm një përforcim i murit.

 SHENJA E KONTROLLIT (shih faqen 57)

تنبيهات الأمان

- ⚠ يجب ارتداء قفازات لليد أثناء التركيب لتجنب حدوث أضرار الإنحشار أو الجروح.
- ⚠ لا يجب استخدام المنتج إلا في أغراض الاستحمام والأغراض الصحية وأغراض تنظيف الجسم.
- ⚠ لا يسمح لأي أطفال أو أفراد بالغين يعانون من إعاقات بدنية أو ذهنية أو حسية أو يعانون من جميع هذه الإعاقات باستخدام المنتج إلا تحت إشراف آخرين. كما أنه لا يسمح لأي شخص تحت تأثير تناول الكحول أو المخدرات باستخدام نظام الدش.
- ⚠ يجب تجنب حدوث اتصال مباشر بين الماء الخارج من رأس الدش وبين أجزاء الجسم الحساسة (مثل العينين). يجب وجود مسافة كافية بين رأس الدش والجسم.
- ⚠ يجب أن يكون تيار الماء الساخن والماء البارد متعادلين في الضغط.

توصيلة كهربائية

- ⚠ لا يجوز القيام بالتوصيلات الكهربائية إلا عن طريق فني كهرباء متخصص!
- ⚠ ضبط إمداد الطاقة مقدماً 230V/NPE/50Hz (الطول 0,3 م)
- ⚠ يجب الالتزام بالقواعد السارية كل على حده عند عمل التركيبات الكهربائية، وذلك بالنظر إلى قواعد إتحاد الصناعات الإلكترونية (VDE)، وقواعد الدولة، وقواعد الإتحاد الأوروبي لفحص وتحليل الحوادث (E.VU).
- ⚠ **مد طاقة خاطئ - تجهيزة حماية**
- ⚠ يتم التأمين من خلال تجهيزة حماية ضد اختلاف التيار (RCD/FI) عند اختلاف التيار لأقل من أو يساوي 30 مللي أمبير.

مختص تركيب إلكترونيات

- ⚠ يتعين القيام بكافة أعمال التركيب والفحص من قبل فني كهرباء معتمد مع الأخذ في الاعتبار الالتزام بالمعيار VDE 0100 الجزء 701 و 701-7IEC 60364.

تعليمات التركيب

- / قبل القيام بعملية التركيب، يجب فحص المنتج للتأكد من خلوه من أية تلفيات ناتجة عن النقل. بعد القيام بعملية التركيب، لن يتم الاعتراف بوجود أية تلفيات سطحية أو تلفيات ناتجة عن عملية النقل.
- / يجب تركيب وغسيل واختبار التوصيلات وخلطات المياه طبقاً للمعايير السارية.
- / يجب مراعاة القواعد الخاصة بالتركيب وأعمال السباكة وفقاً للوائح الخاصة بكل بلد.
- / عند التركيب بواسطة عمال تركيب متخصصين يجب الإنتباه إلى أن مساحة التثبيت في مكان التركيب بوجه عام مسطحة (لا توجد روابط أو فروق للربط بين البلاطات). لذا يجب التأكد من أن الحائط الذي سيتم تركيب المنتج عليه صالح لذلك وأنه لا يوجد به نقاط ضعف.
- / يجب الحذر عند الثقب فوق وصلات كهرباء أو مياه!
- / يجب أن يكون الأداء من حيث حجز الفضلات ذا حجم مناسب.

المواصفات الفنية

الحد الأقصى 1 ميجاباسكال	ضغط التشغيل:
0,5 - 0,1 ميجاباسكال	ضغط التشغيل الموصى به:
1,6 ميجاباسكال	ضغط الاختبار:
(1 ميجاباسكال = 10 بار = 147 PSI)	
الحد الأقصى 70°C	درجة حرارة الماء الساخن:
65°C	درجة الحرارة الموصى بها للماء الساخن:
G1/2 & G3/4	الوصلات:
	معدل التدفق عند ضغط 0,3 ميجاباسكال:
44 لتر / الدقيقة	10750180 (1 المستهلك)
55 لتر / الدقيقة	10750180 (2 المستهلك)
25 لتر / الدقيقة	10650180
55 لتر / الدقيقة	10971180
50 لتر / الدقيقة	28486180
الحد الأقصى 4/70°C الدقيقة	تعقيم حراري:

المنتج مخصص فقط لماء الشرب!

خاصية عدم التدفق العكسي

وصف الرمز

هام! لا تستخدم السليكون الذي يحتوي على أحماض! 

أبعاد (راجع صفحة 31) 

مثال على التركيب (راجع صفحة 32) 

يجب ضبط ترتيب الأنظمة حسب معطيات البناء

قطع الغيار (راجع صفحة 57) 

مختص تركيب إلكترونيات 

الصيانة 

يجب فحص صمام عدم الرجوع بصفة منتظمة حسب المواصفة DIN EN 1717 وذلك طبقاً للوائح الوطنية أو الإقليمية (مرة واحد سنوياً على الأقل).

توصيلة مياه DN20 

ماء دافئ

توصيلة مياه DN20 

ماء بارد

معادلة الجهد الكهربائي PE 

الموصل المحايد N 

موصل L 

مفتاح حماية FI FI 

مفتاح إضاءة 

محول T 

مادة إضاءة 

توصيلات قابسية 

مقوي ميكروفون 

المنطقة الخاصة بالتدعيم المطلوب للجدار 

يلزم هذا في النطاق وجود تقوية للحائط.

شهادة اختبار (راجع صفحة 57) 

باتيو مزود بدش في المنتصف X 

افتح خلط المياه. / قم بإيقاف المياه 

ماسورة فارغة EN20 

يجب ارتداء قفازات الحماية 

تشغيل/ إيقاف الكهرباء 

ترتيب التركيب 1. 

س المخارج 

قم بسد المنفذ غير المستخدم.

مهبط توصيلة % 

قم بتركيب مواسير المياه للدش العادي المنحدر.

التركيب (راجع صفحة 52) 



AXOR ShowerCollection
10750180

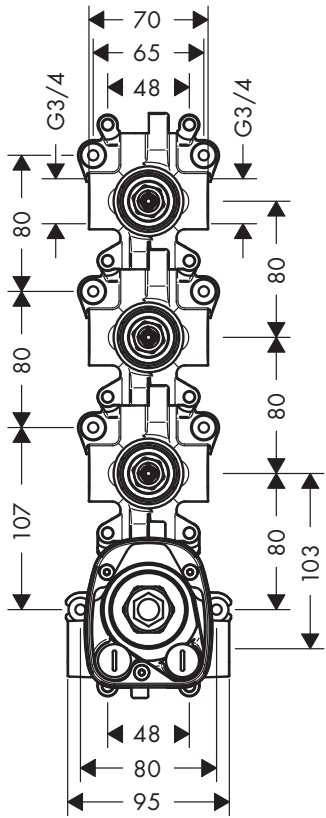

AXOR ShowerCollection
10650180

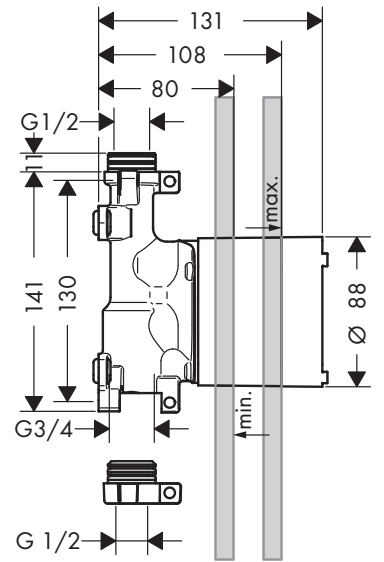
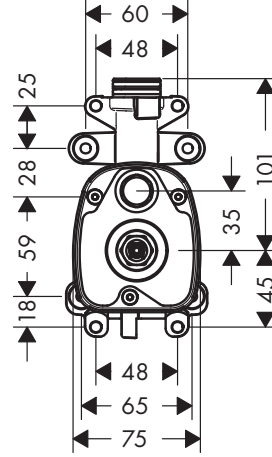

AXOR ShowerCollection
10971180

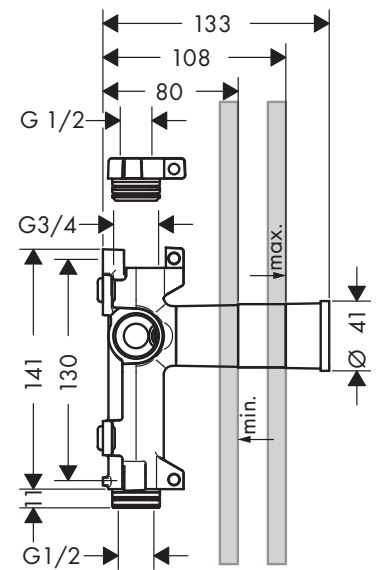
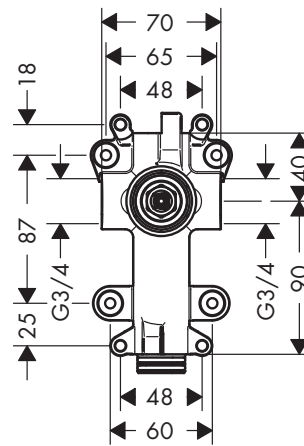

AXOR ShowerCollection
40878180



AXOR ShowerCollection
28486180

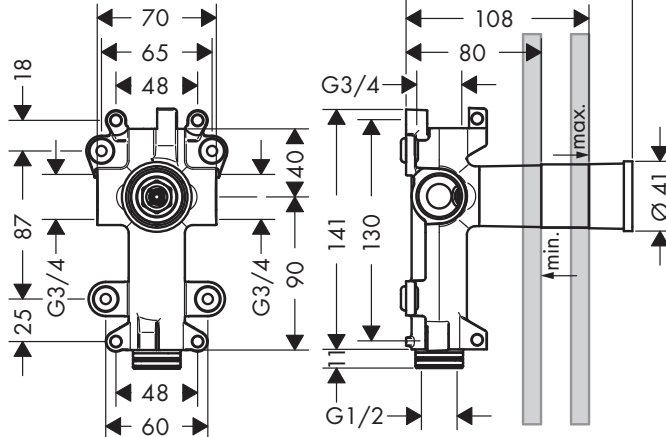

AXOR ShowerCollection
40877180

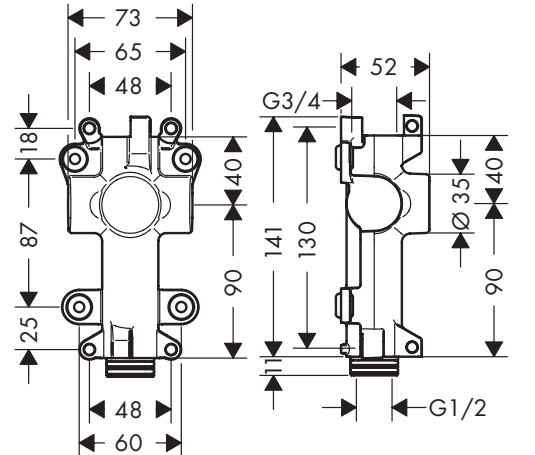

Showerheaven 970 x 970
10621800/10623800

Showerheaven 720 x 720
10625800/10627800

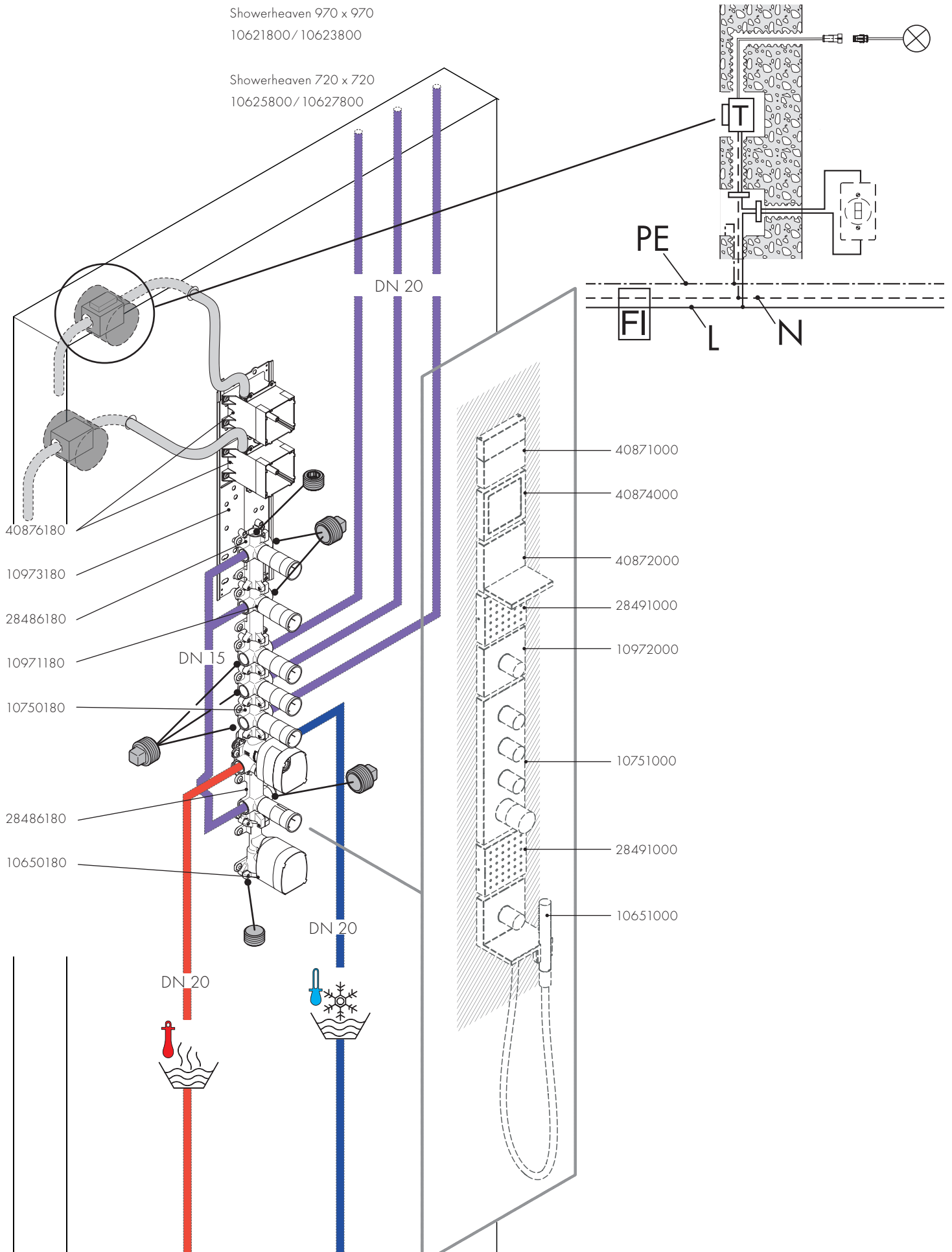

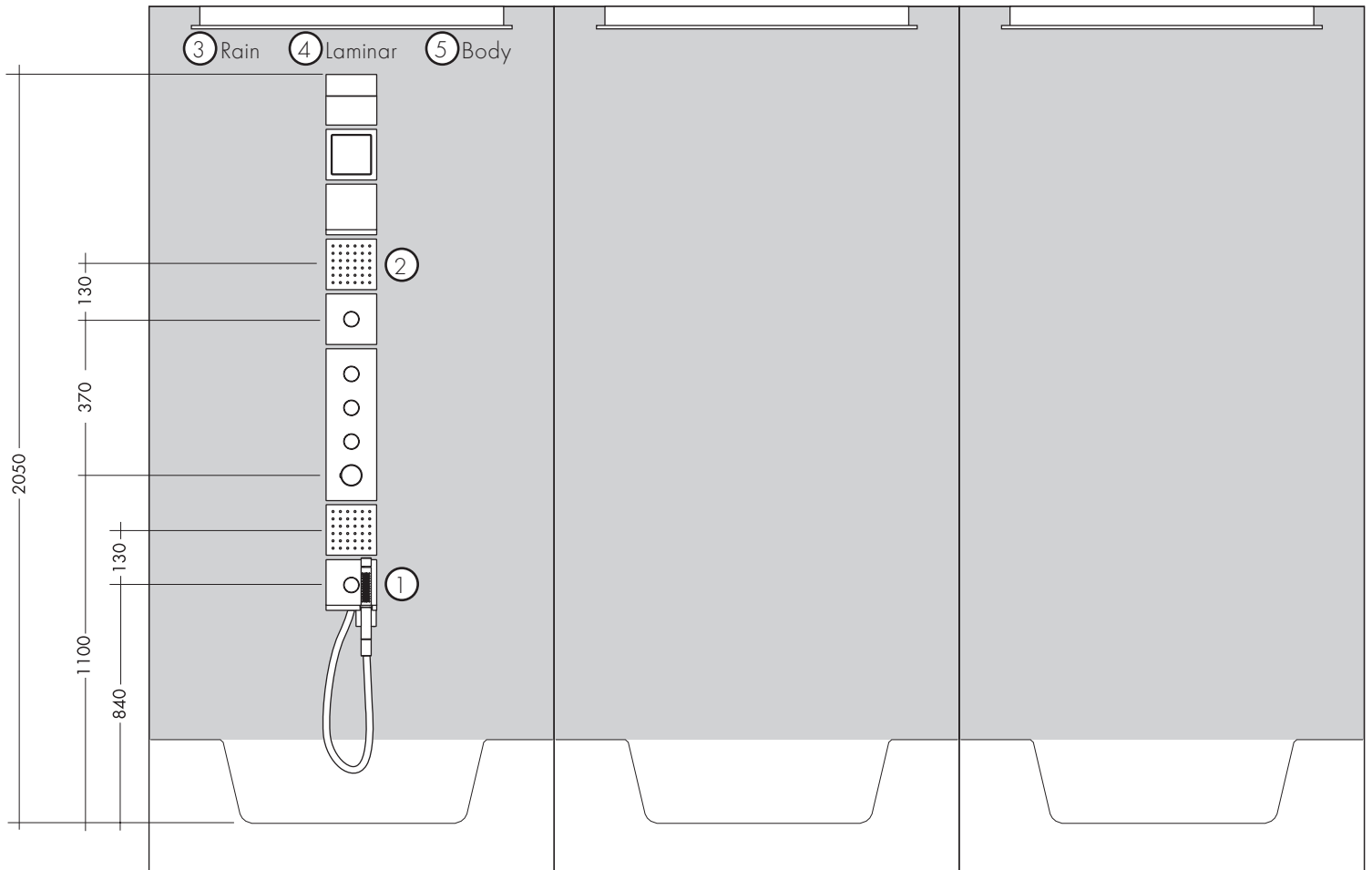
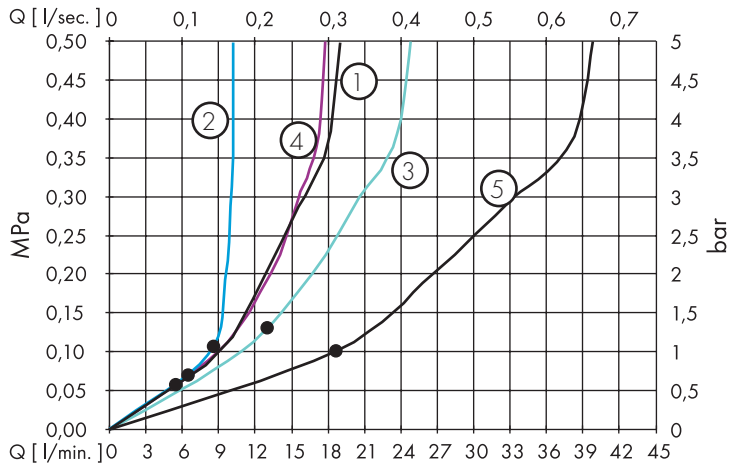

Showerheaven 970 x 970
10621800 / 10623800

Showerheaven 720 x 720
10625800 / 10627800

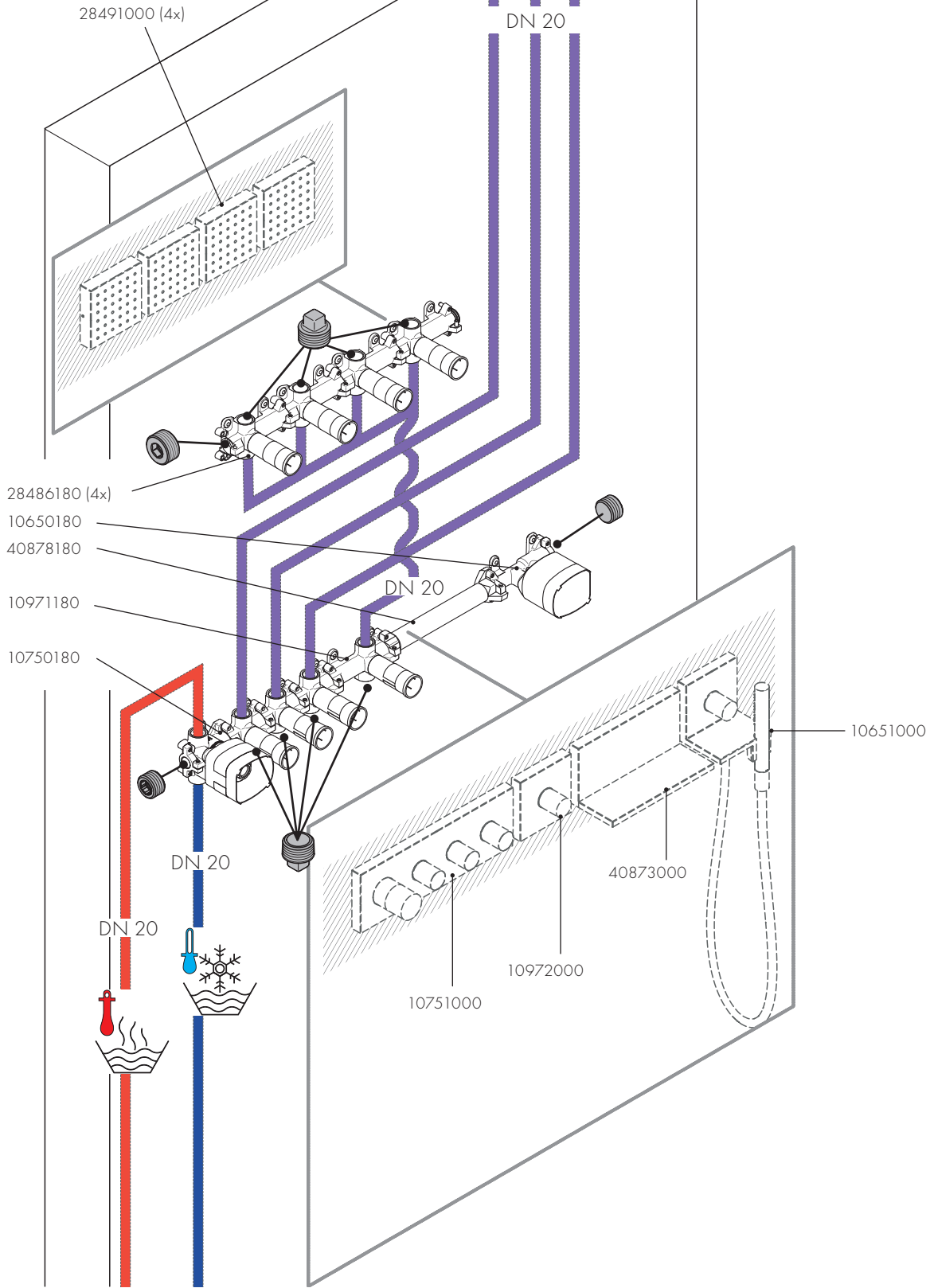

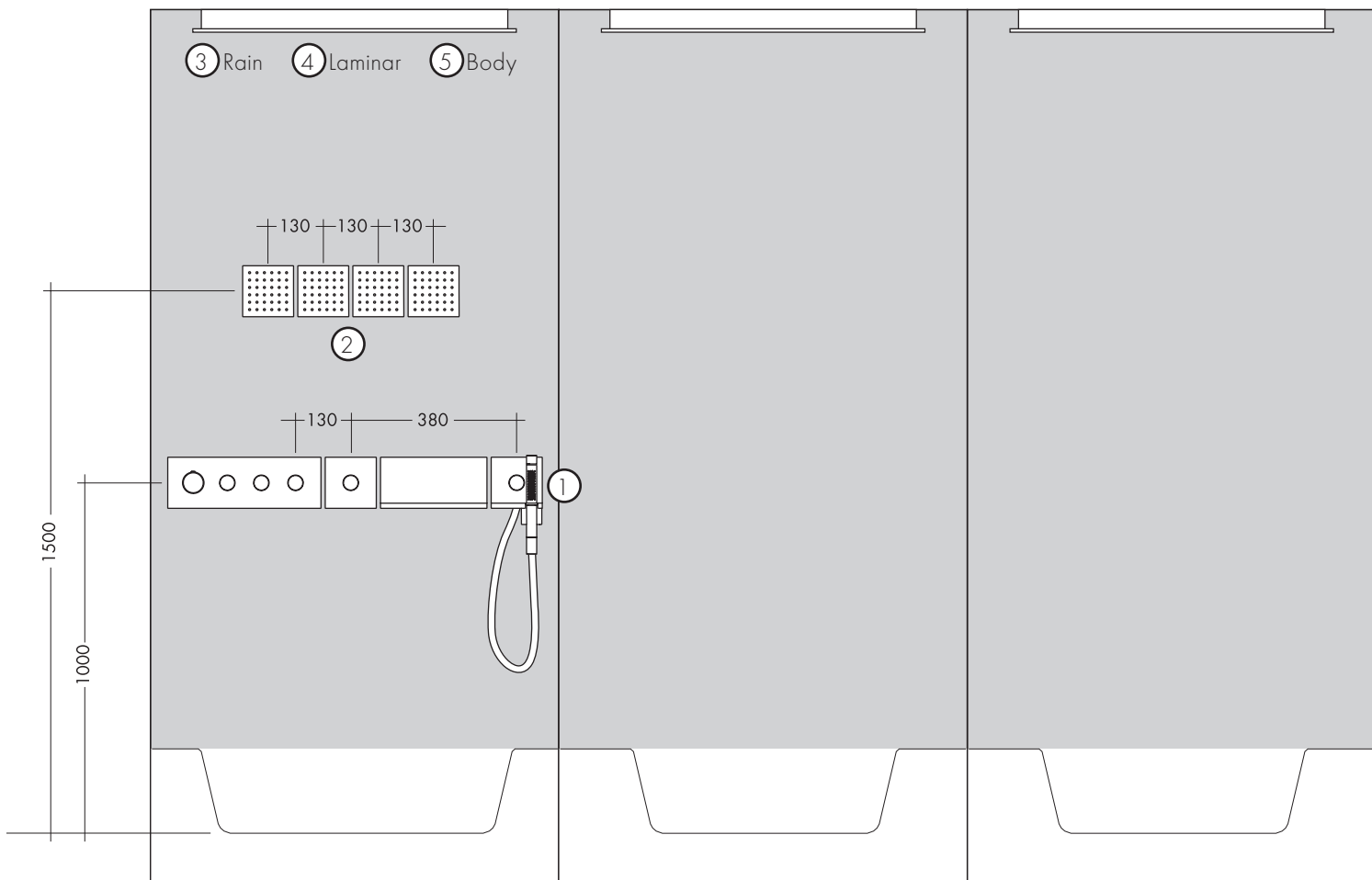
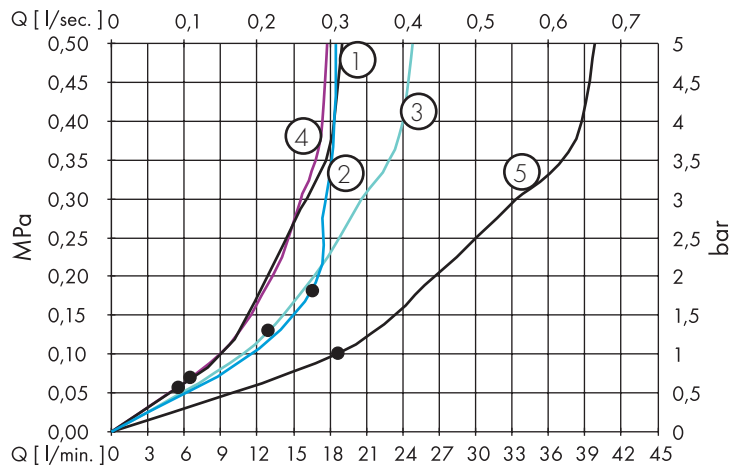

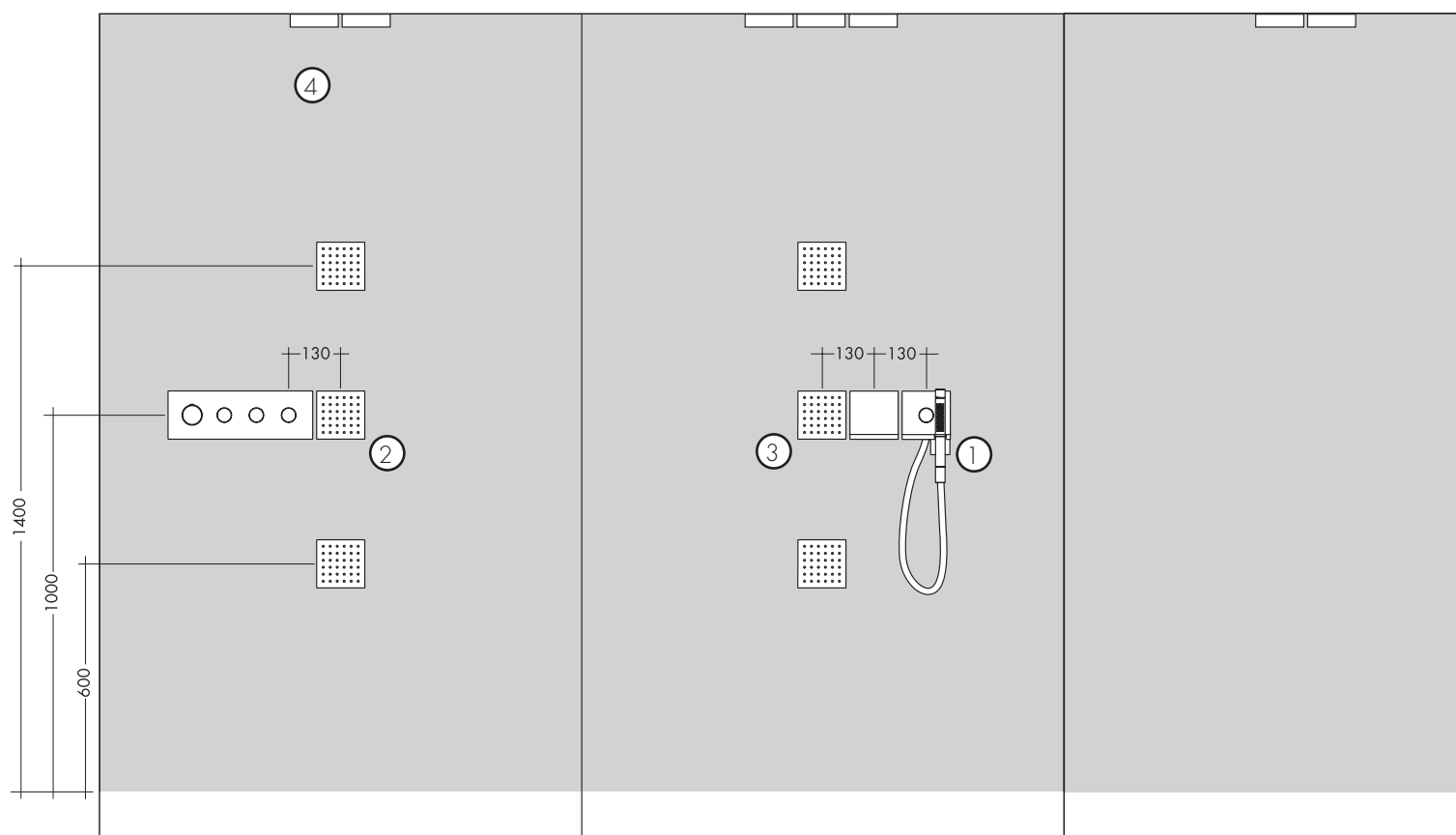
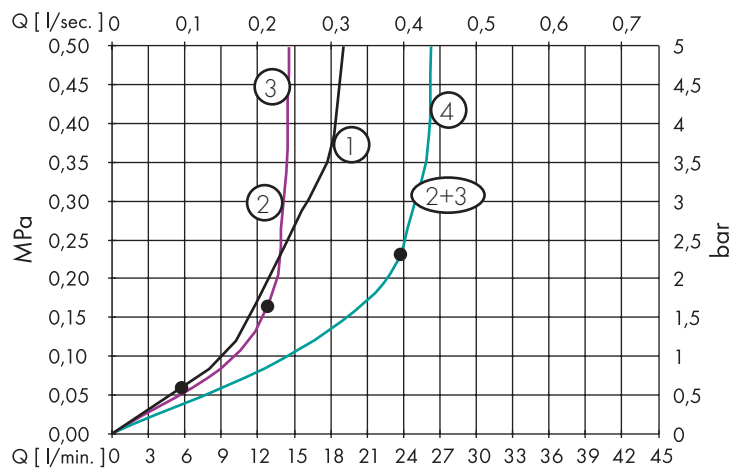

Showerheaven 970 x 970
10621800 / 10623800

Showerheaven 720 x 720
10625800 / 10627800

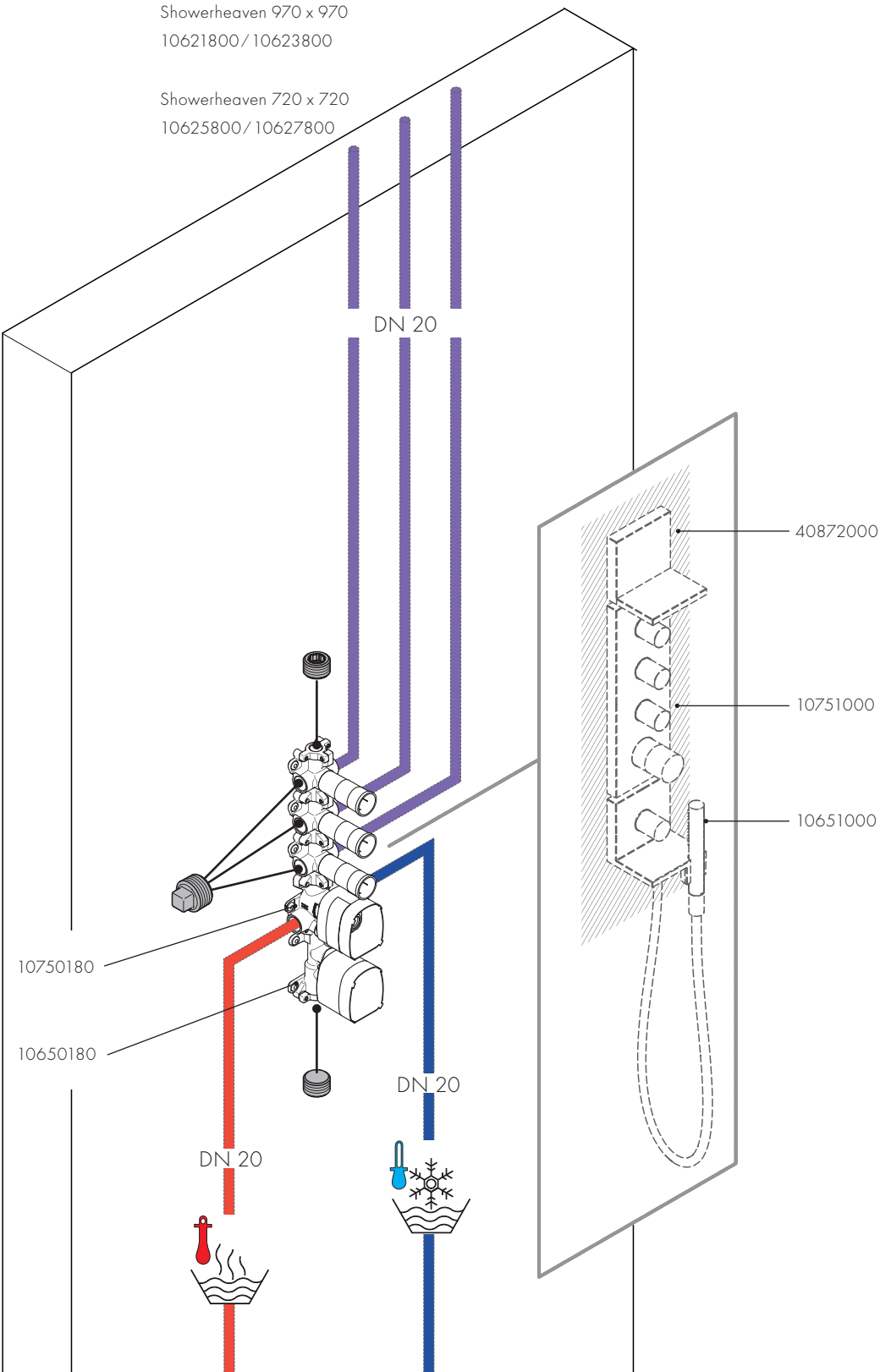

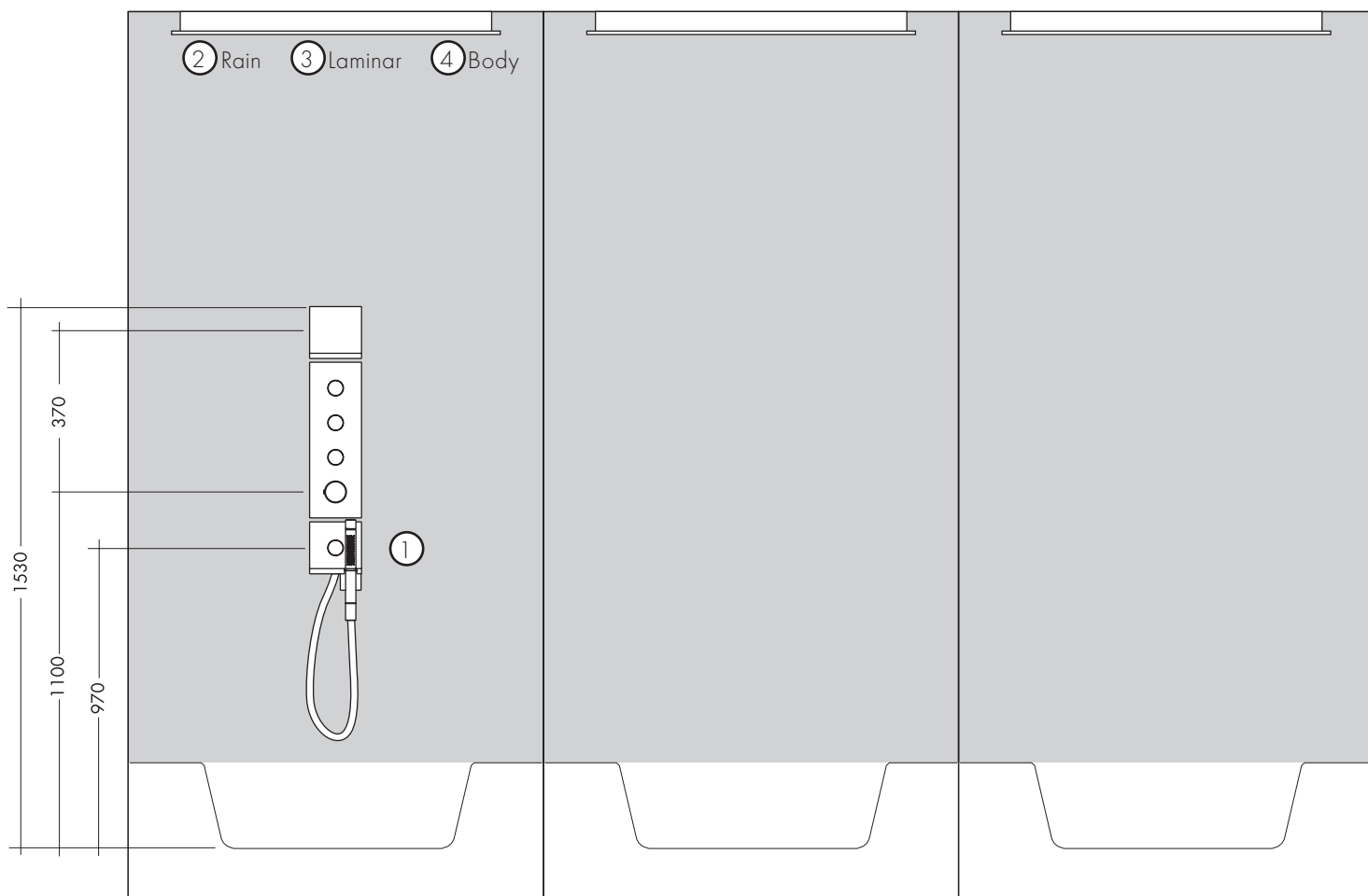
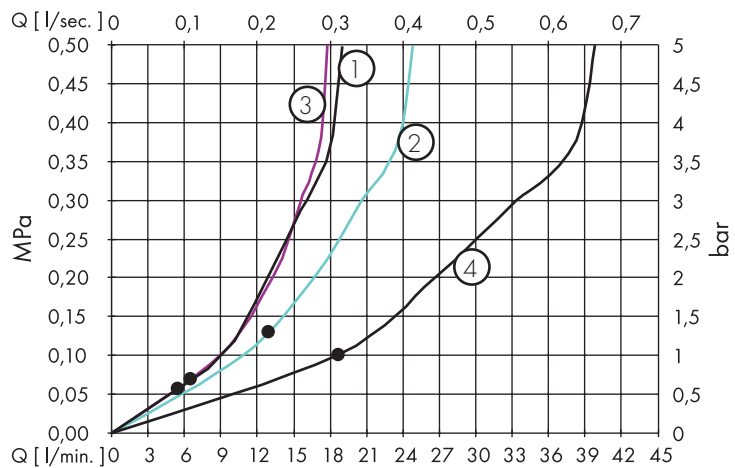

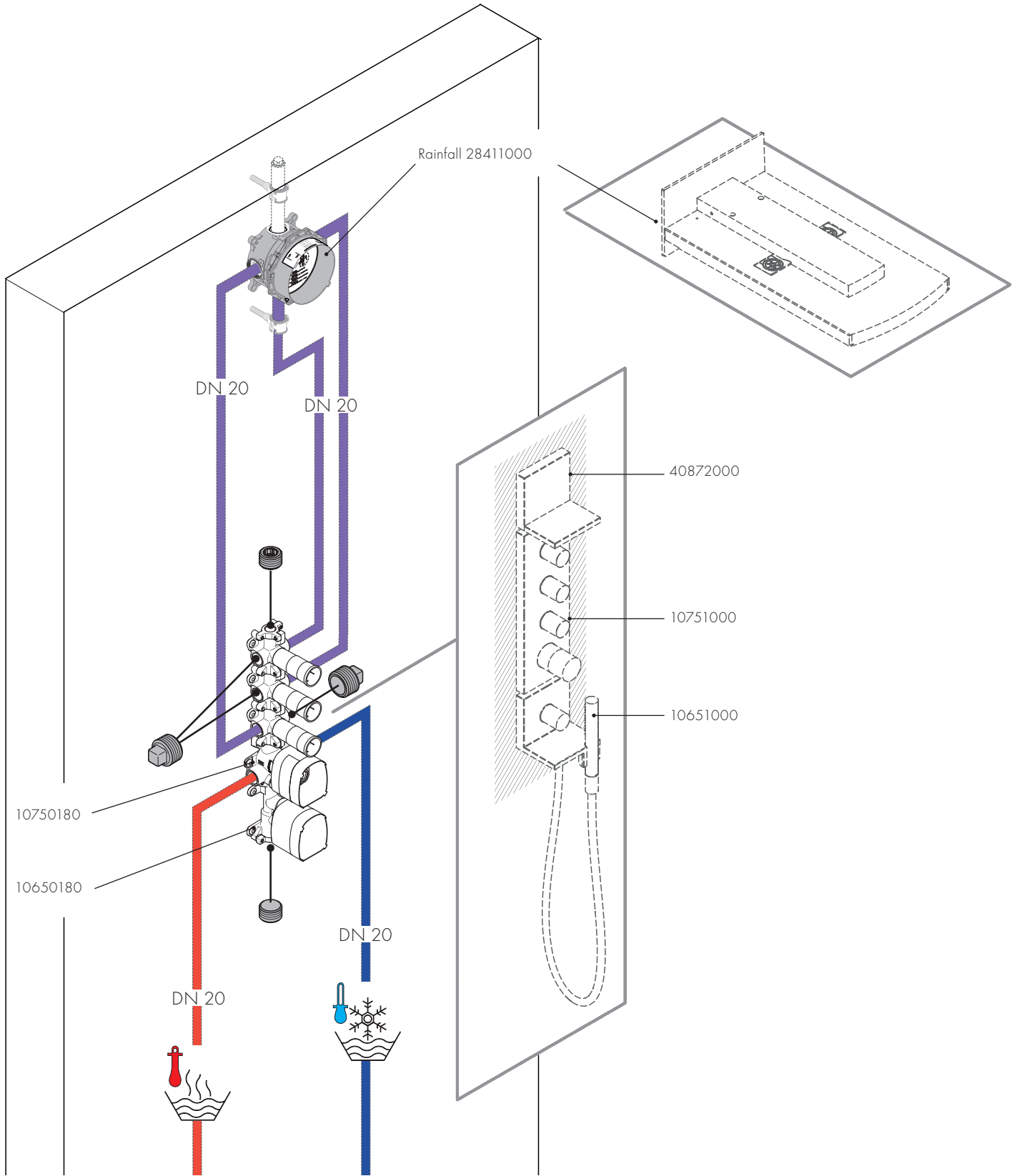

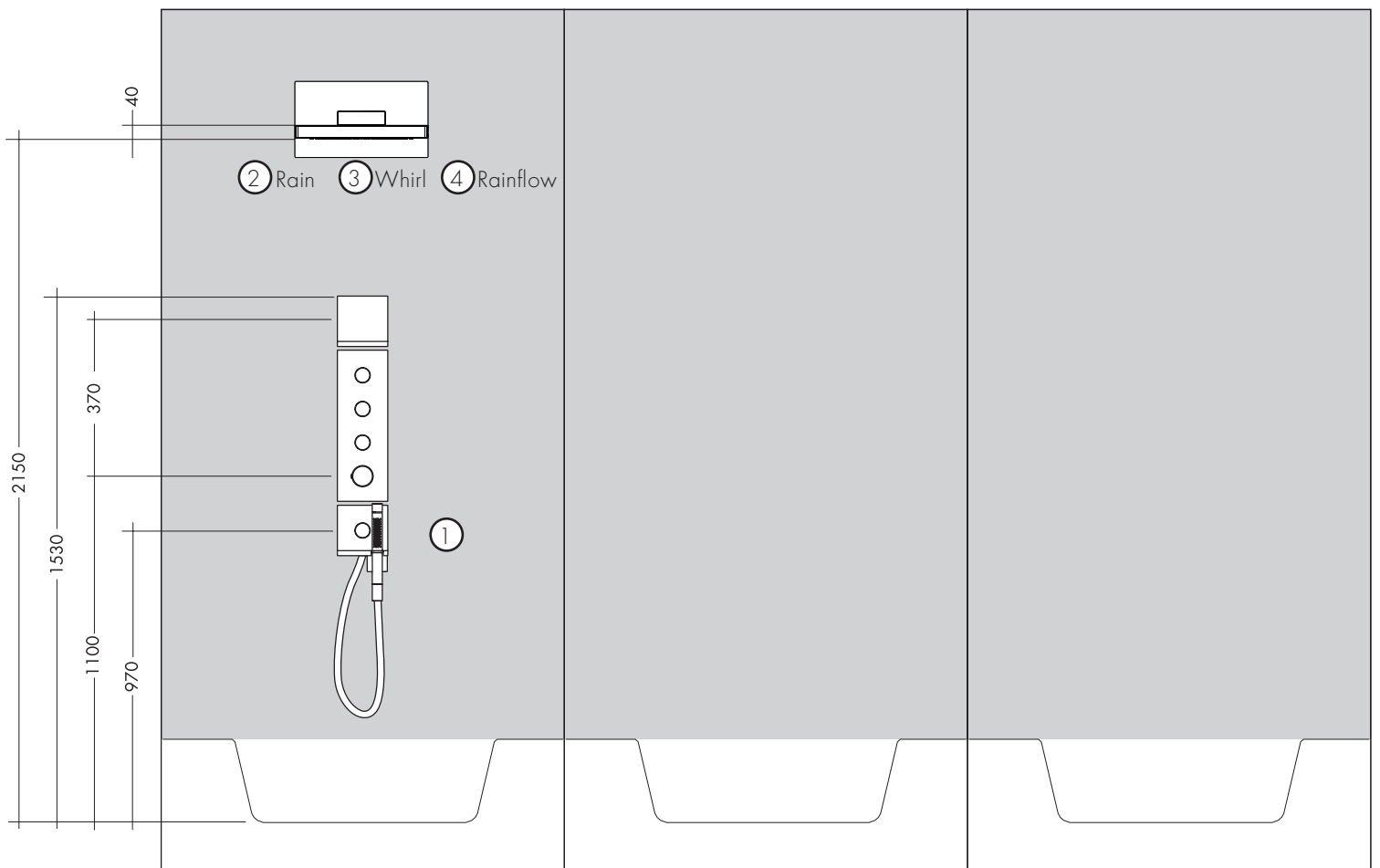
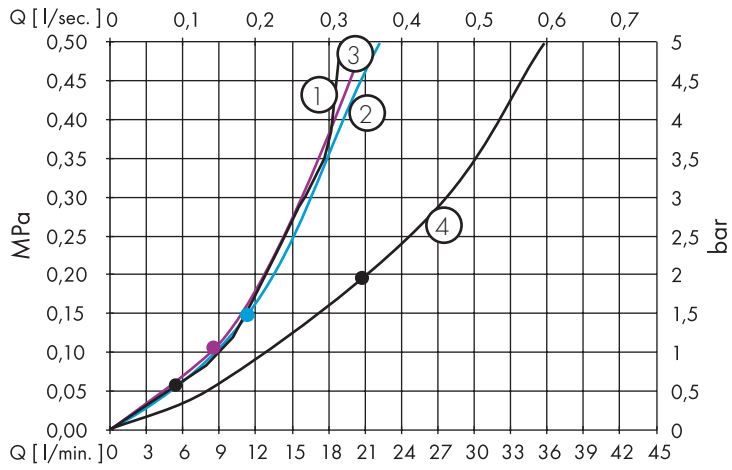

Showerheaven 970 x 970
10621800/ 10623800

Showerheaven 720 x 720
10625800/10627800

DN 20

10650180

10750180

10651000

DN 20

10751000

40873000

DN 20

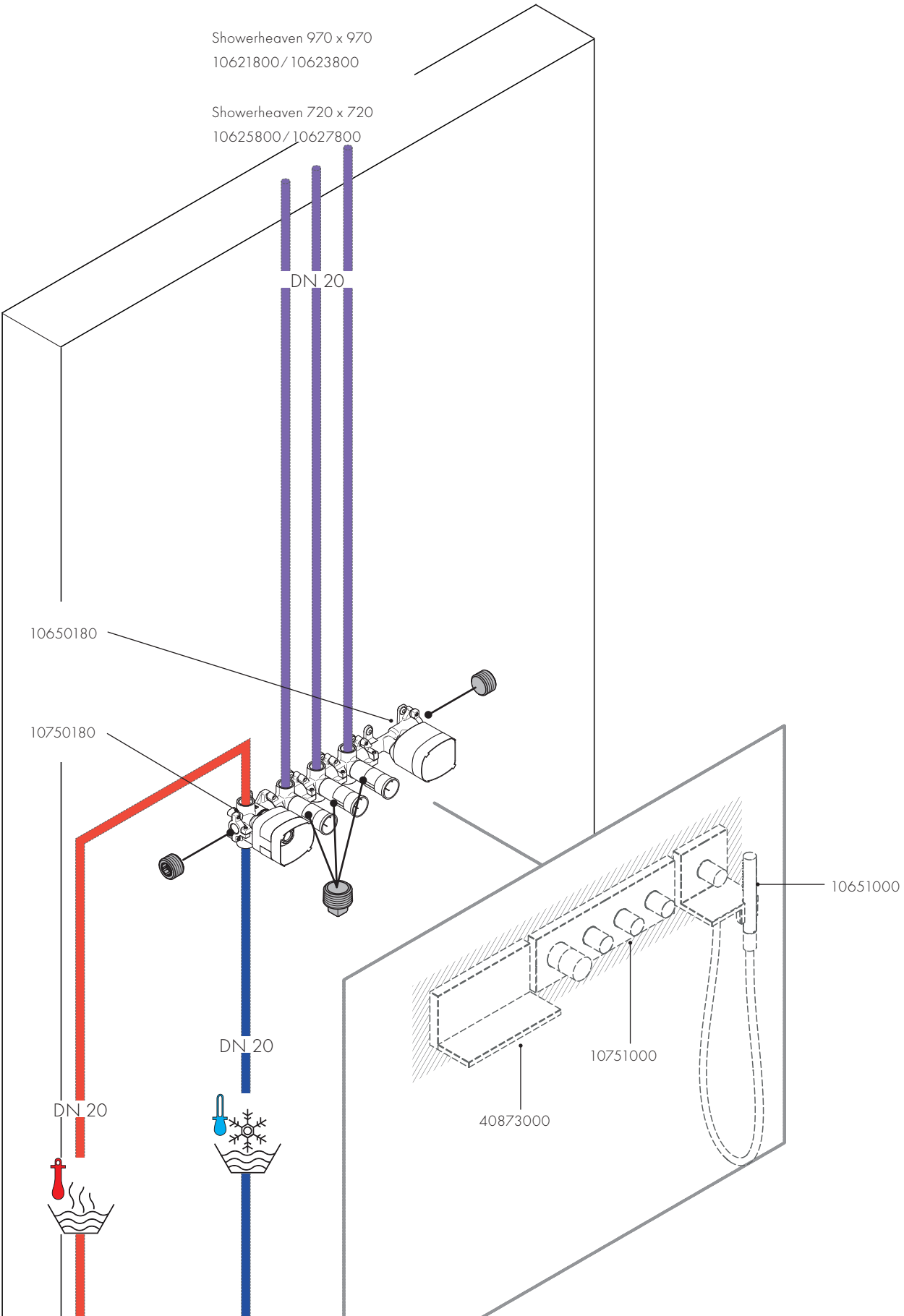

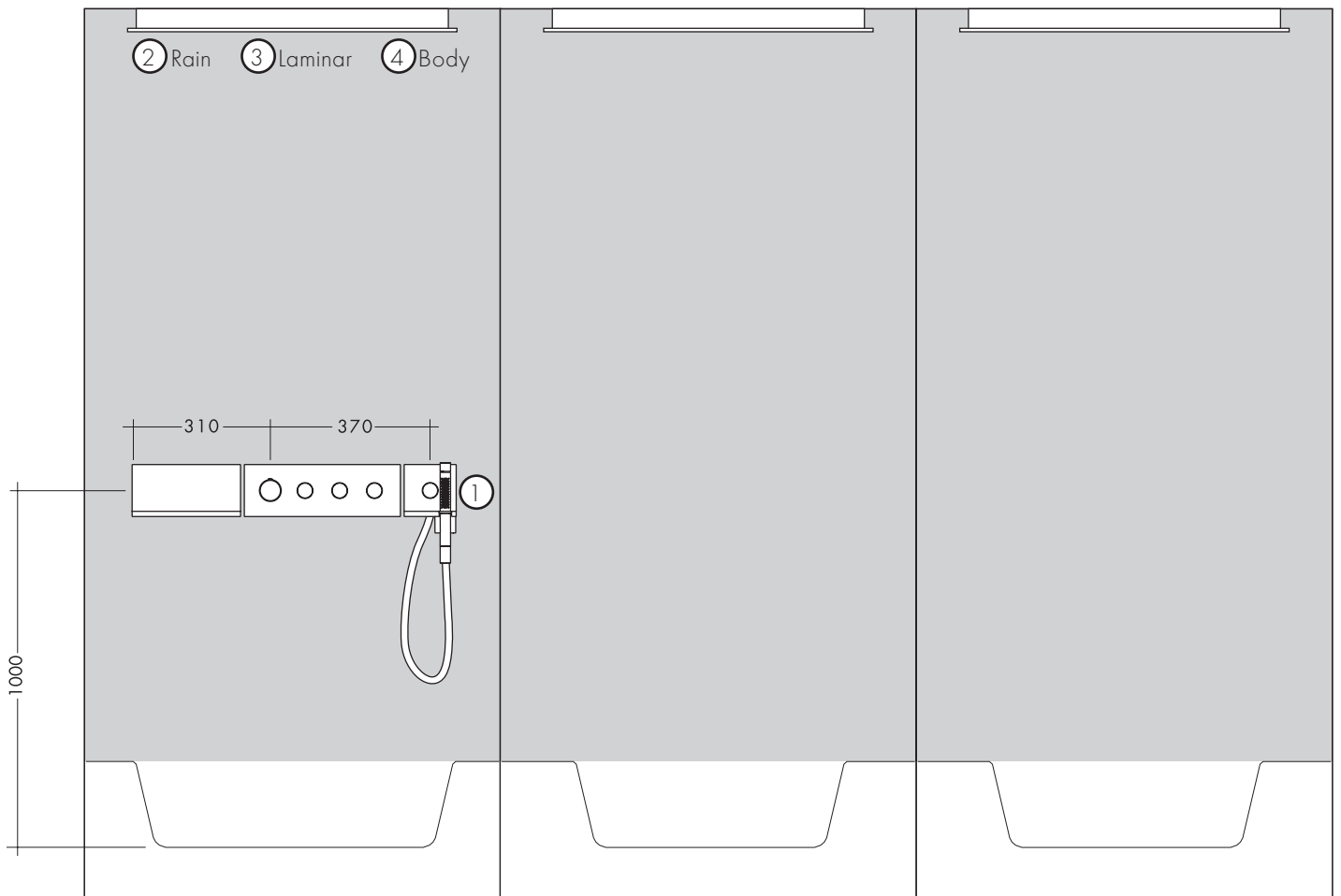
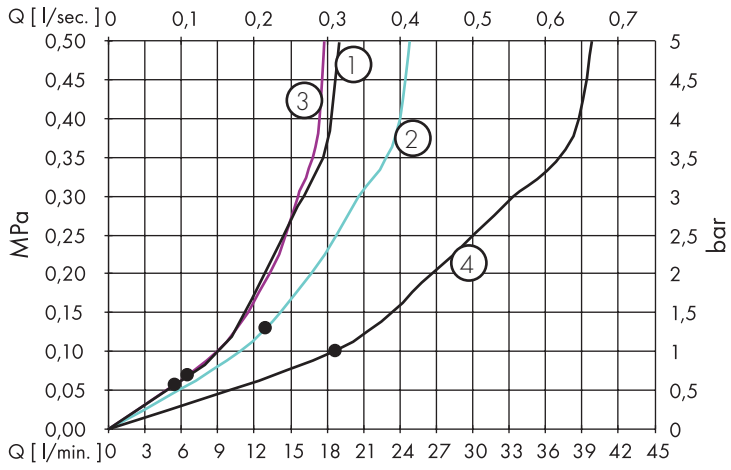

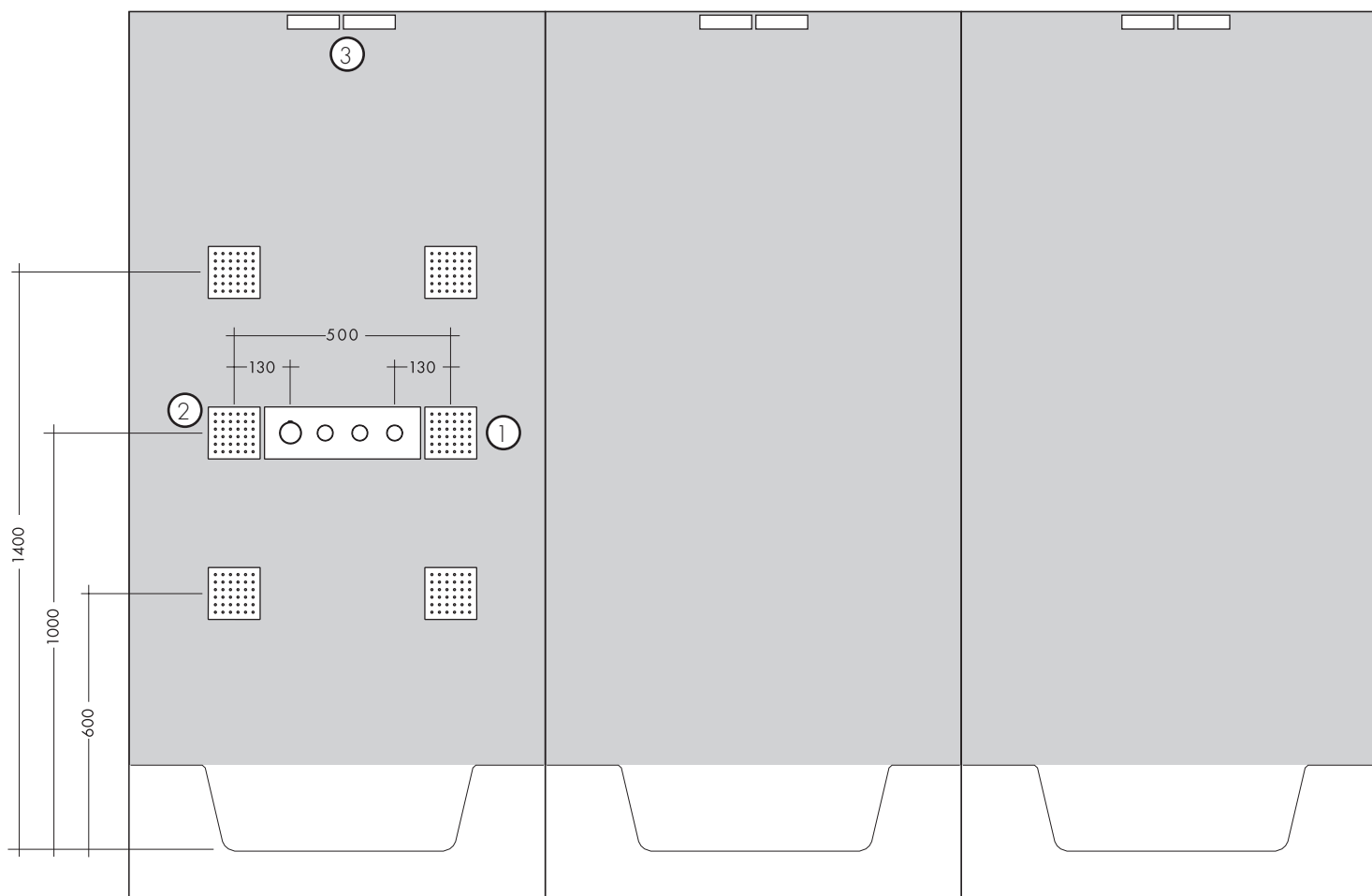
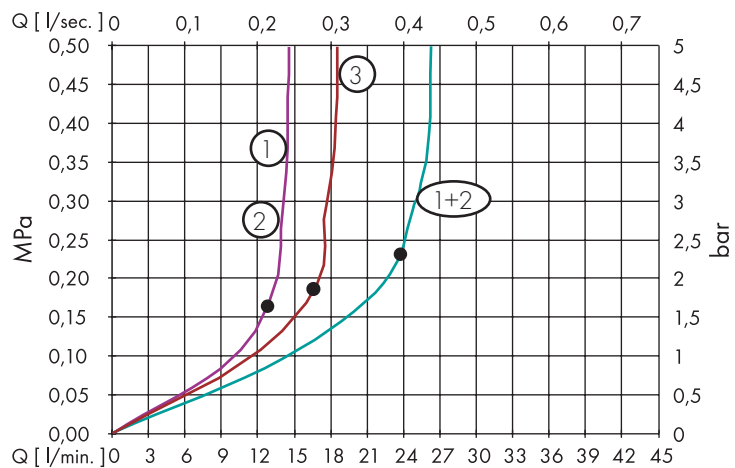

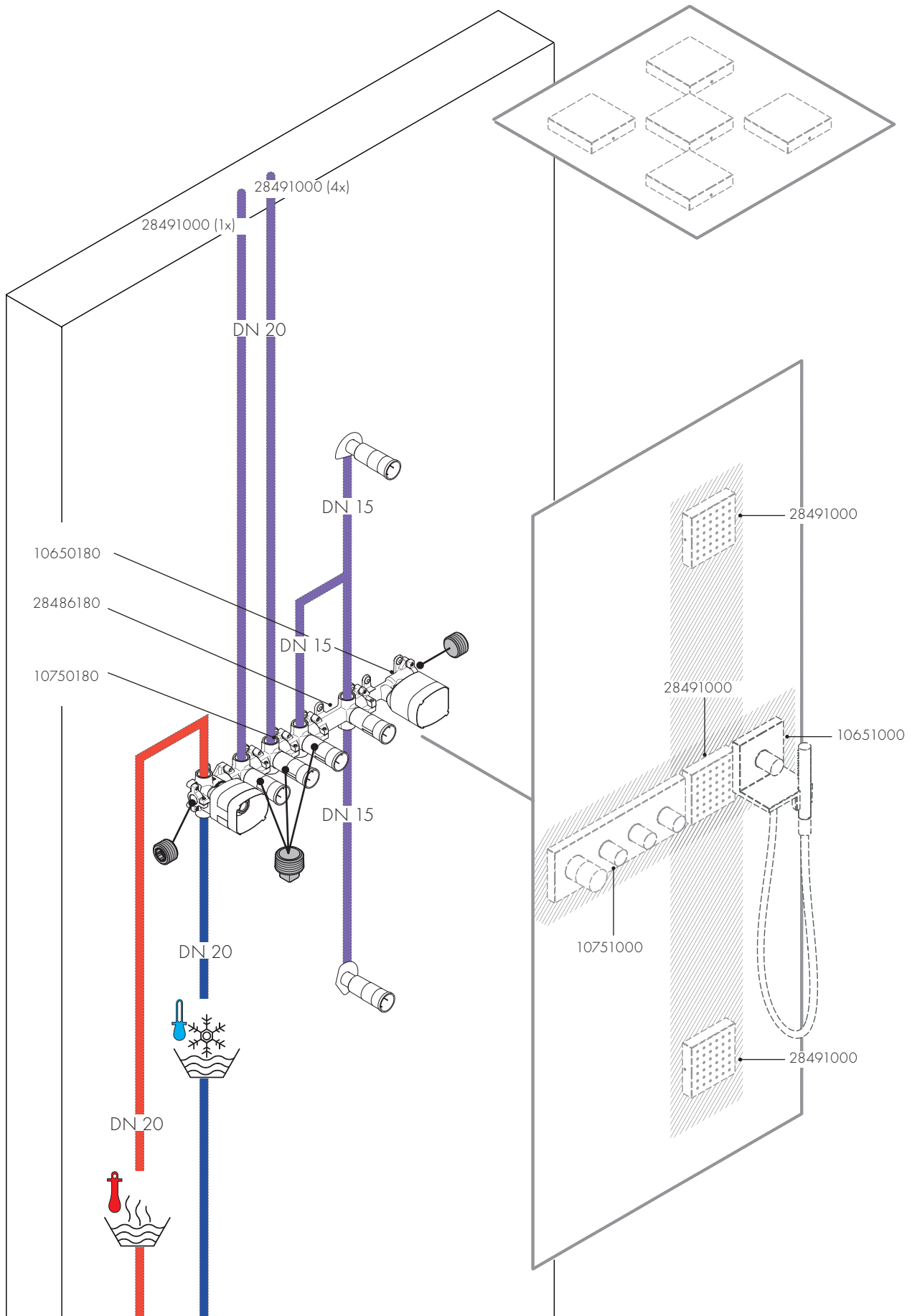

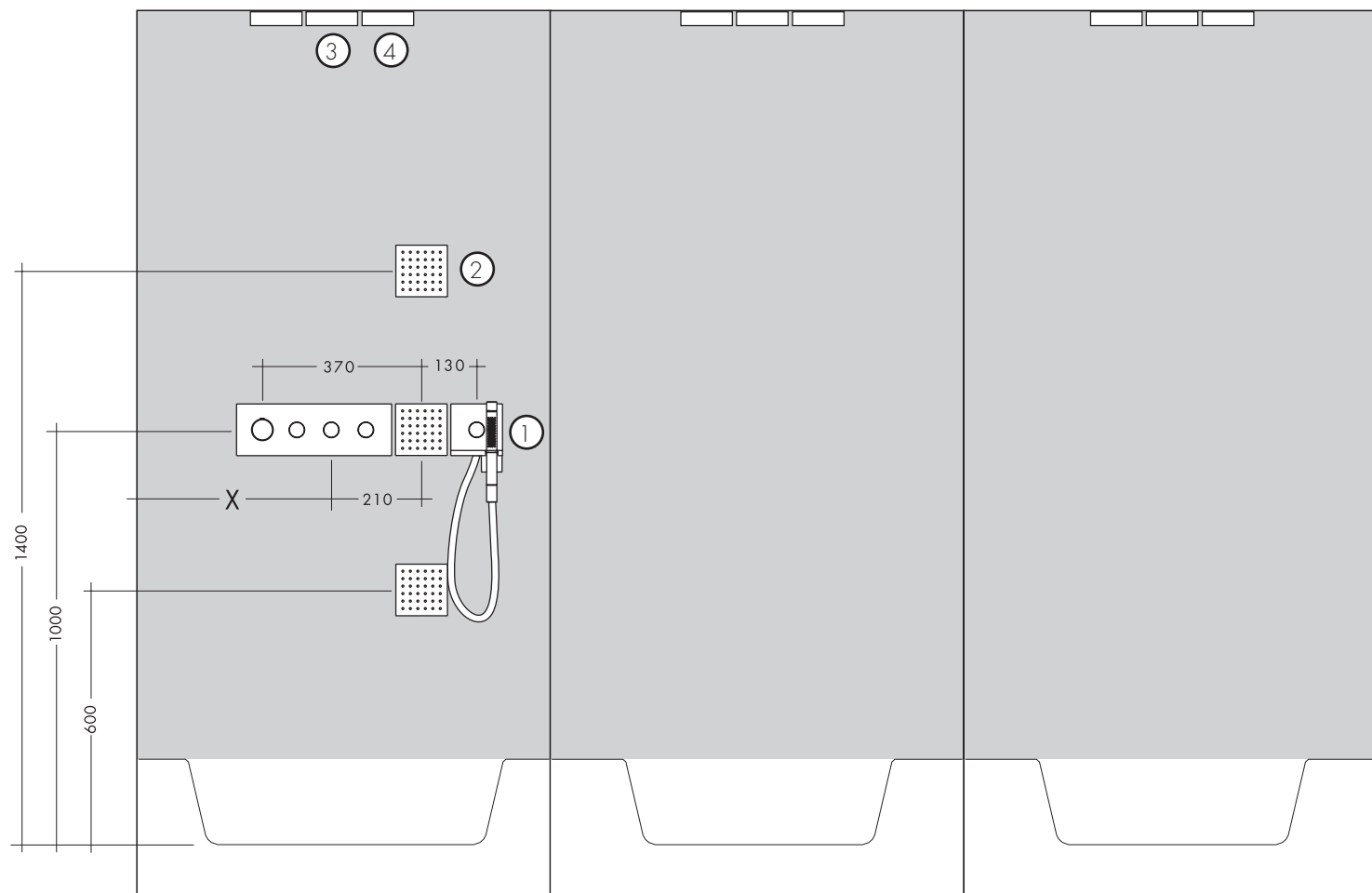
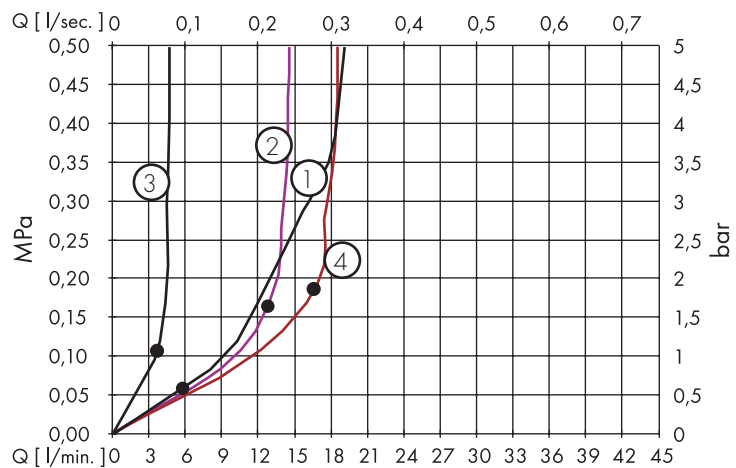

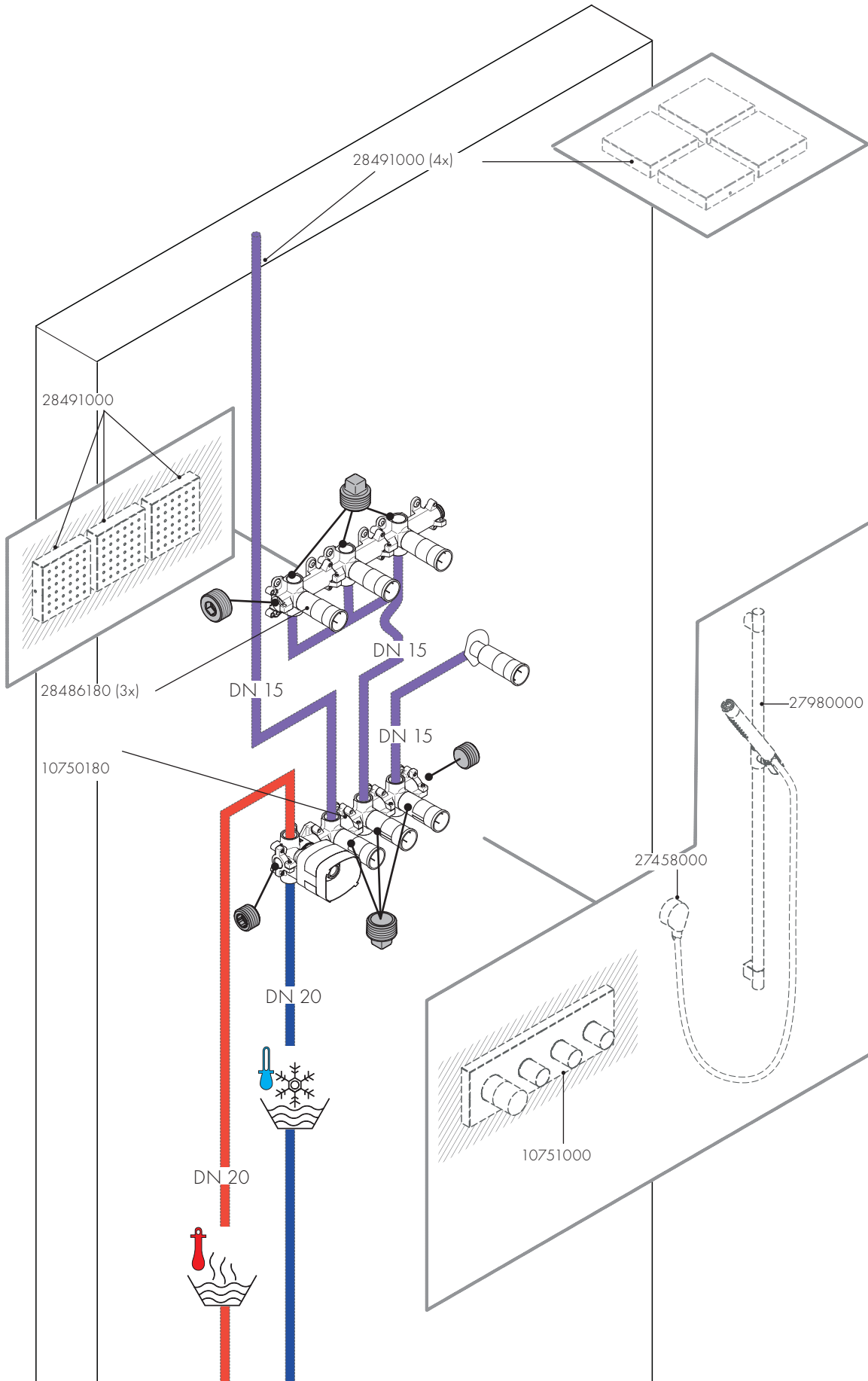

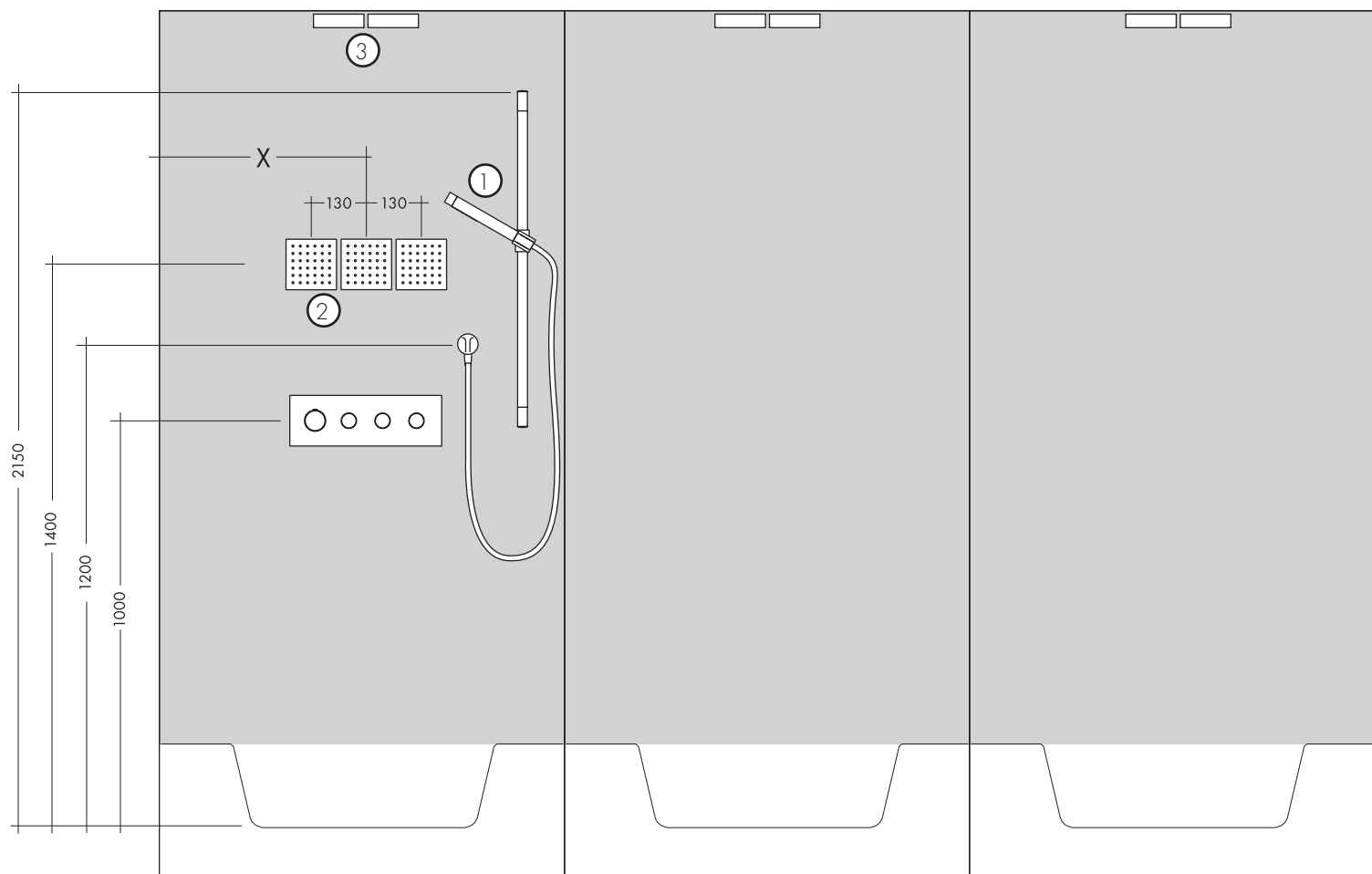
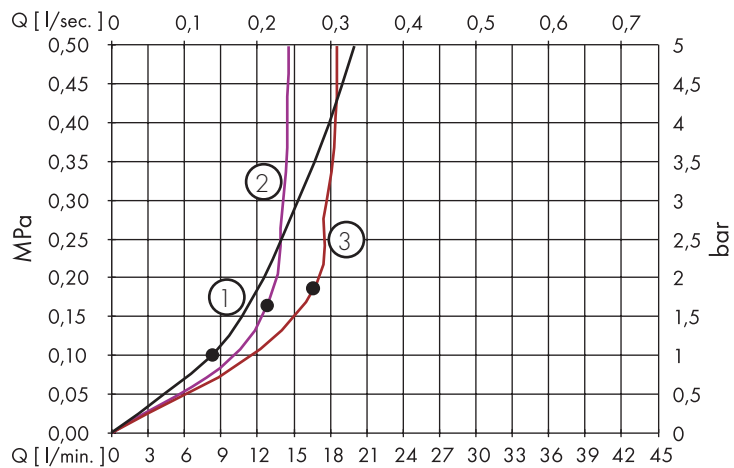

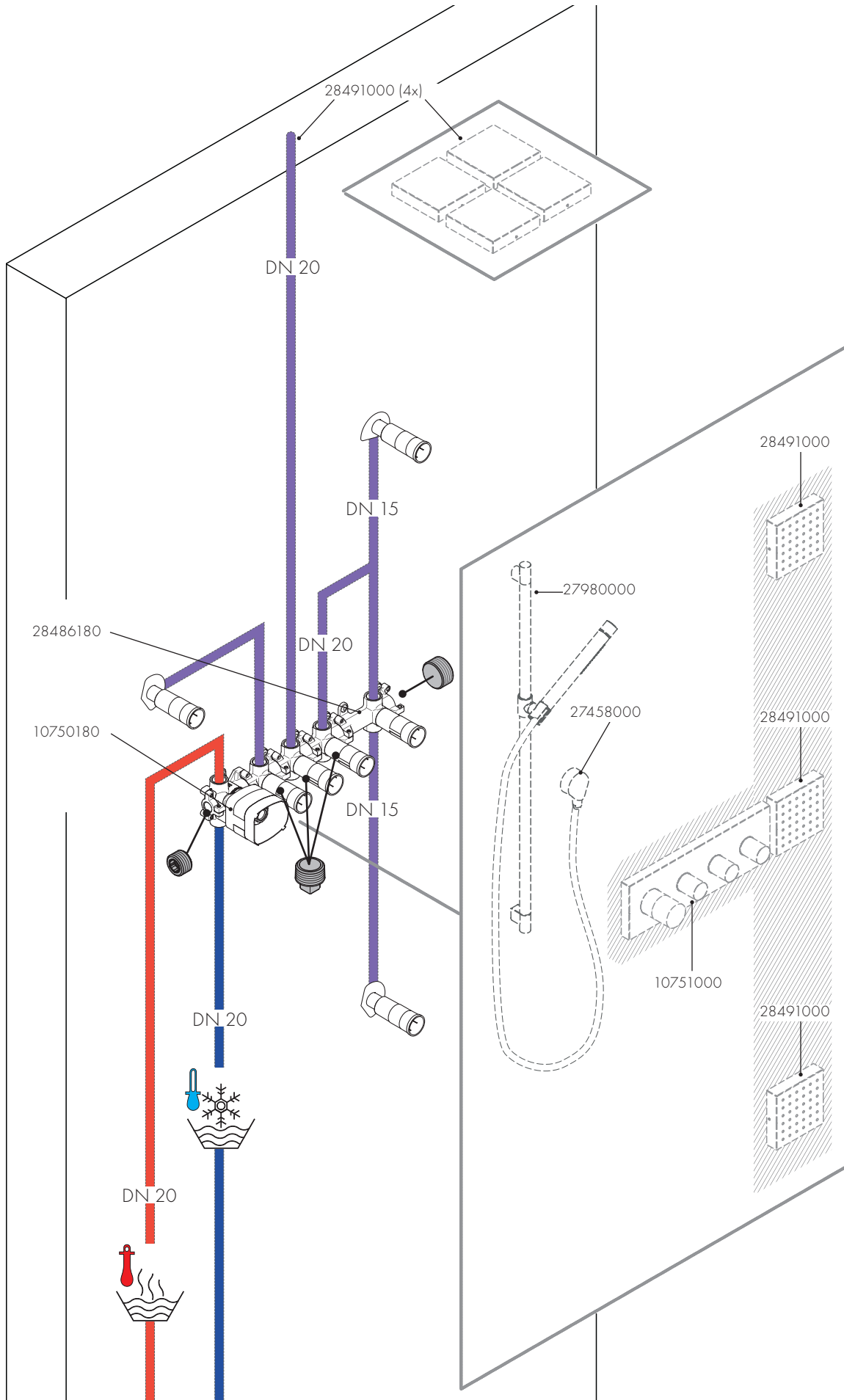

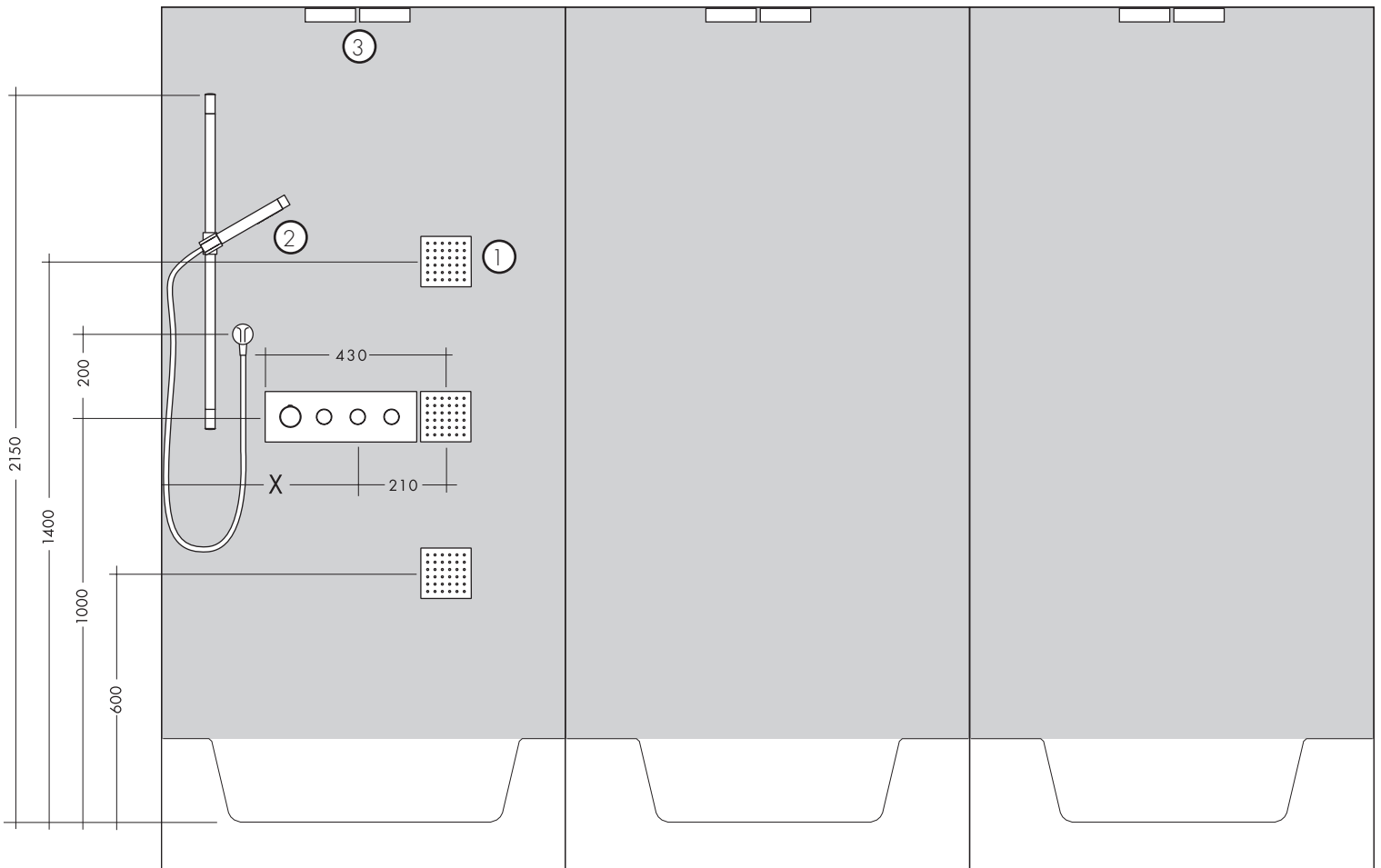
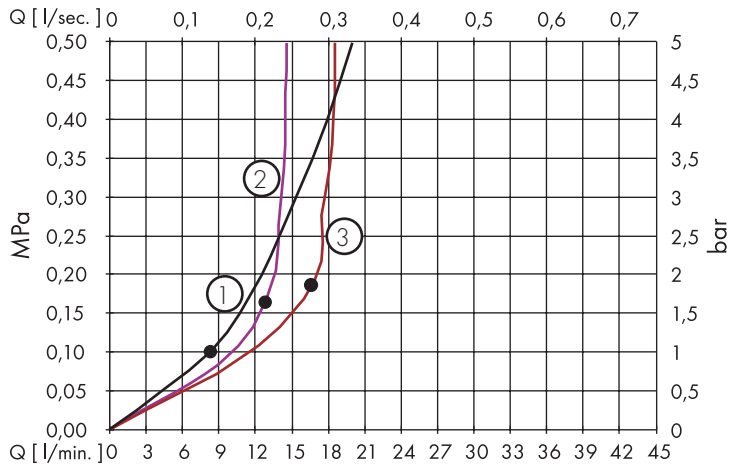

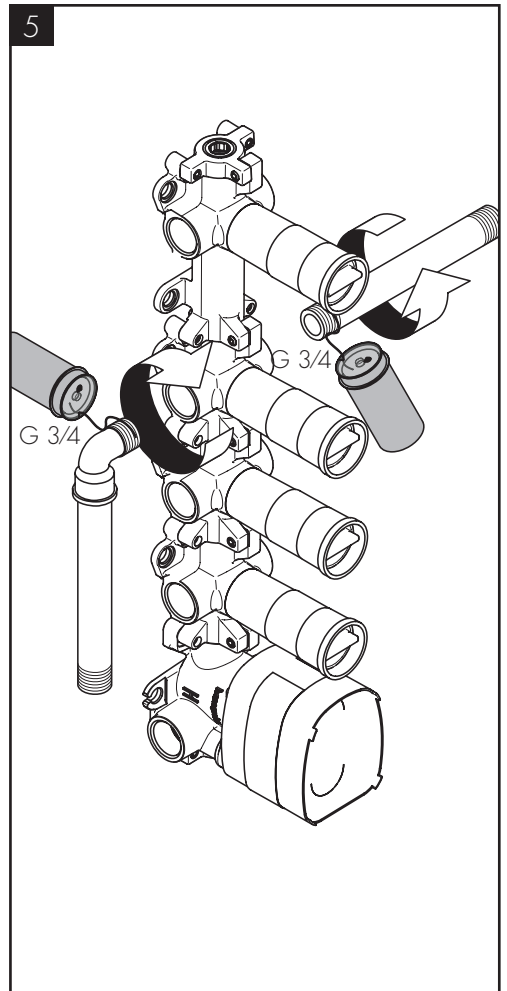
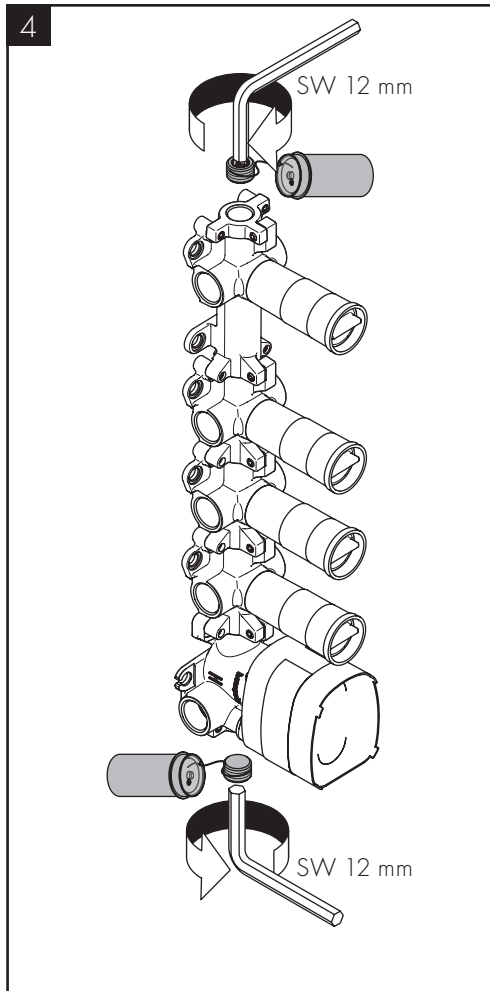
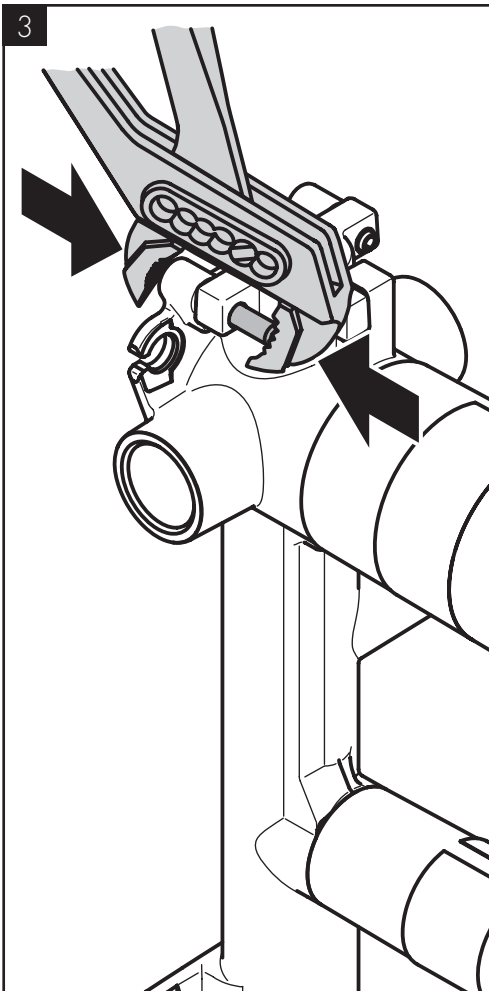
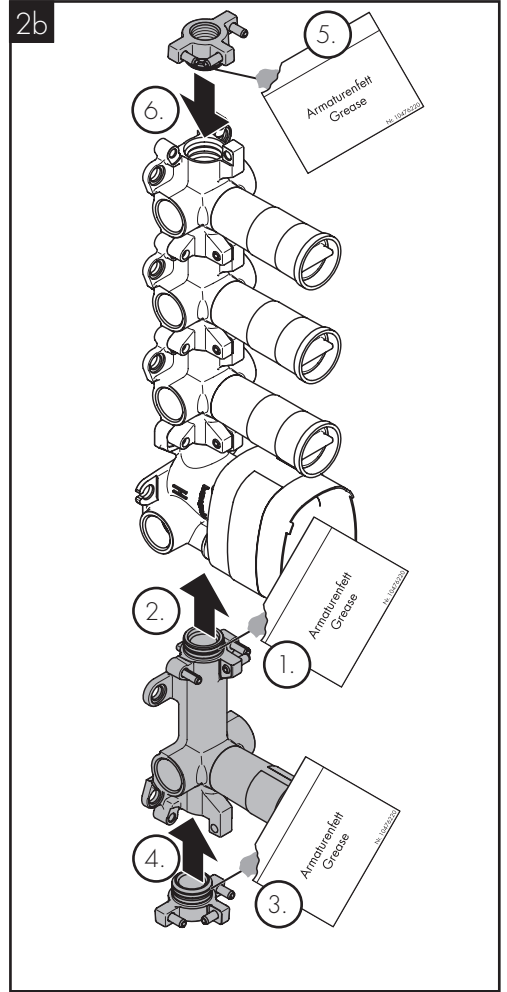
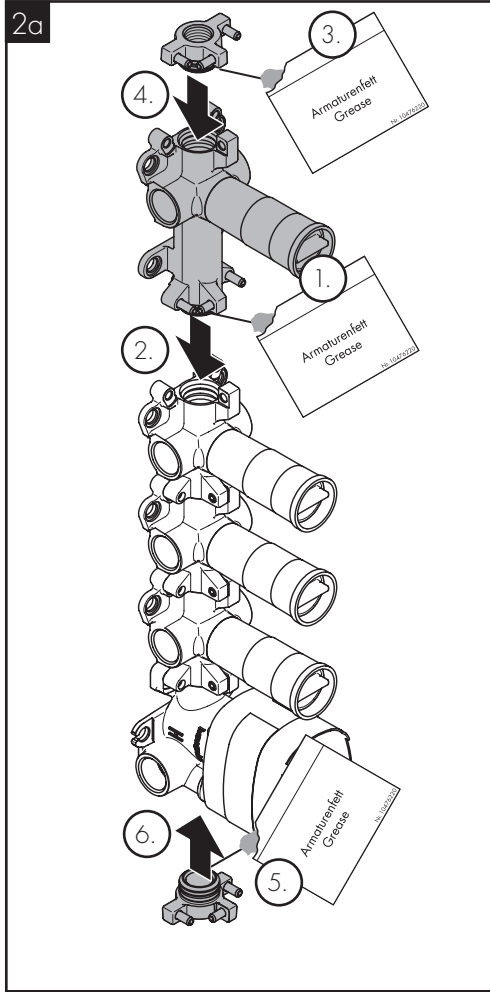
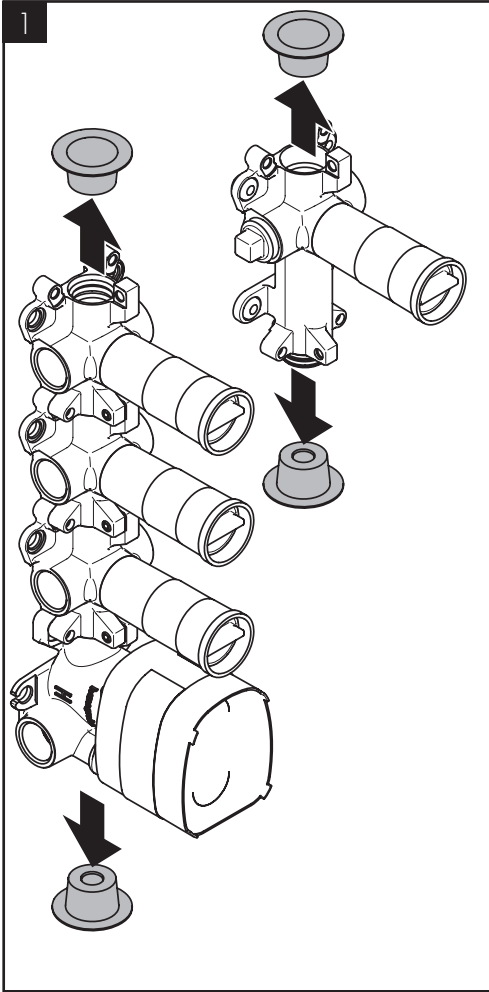

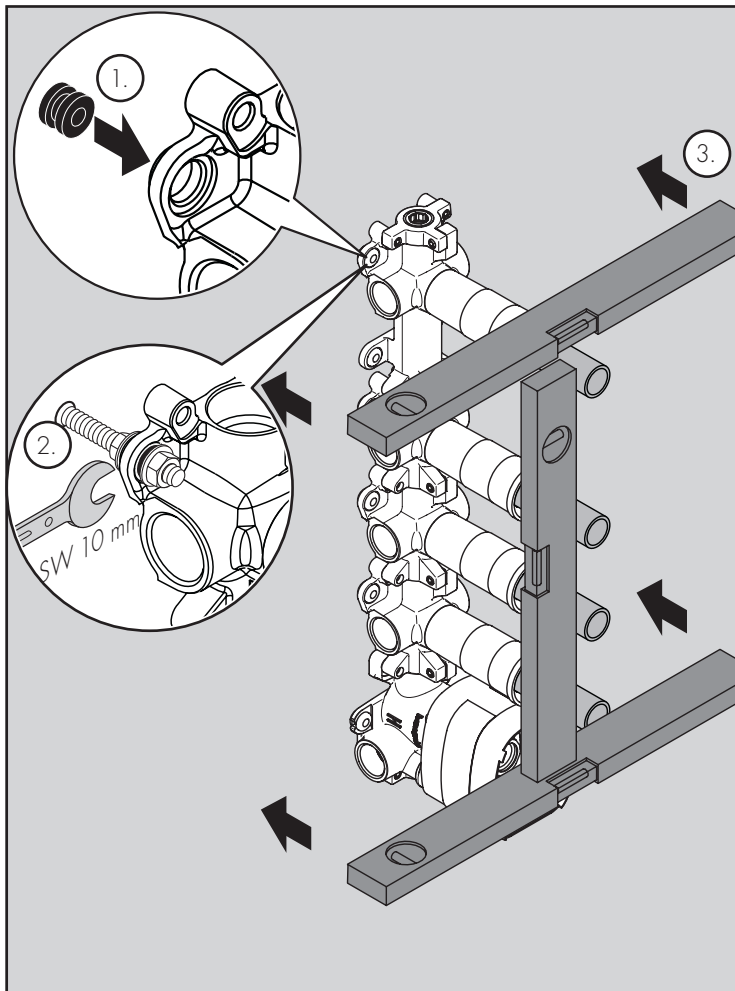
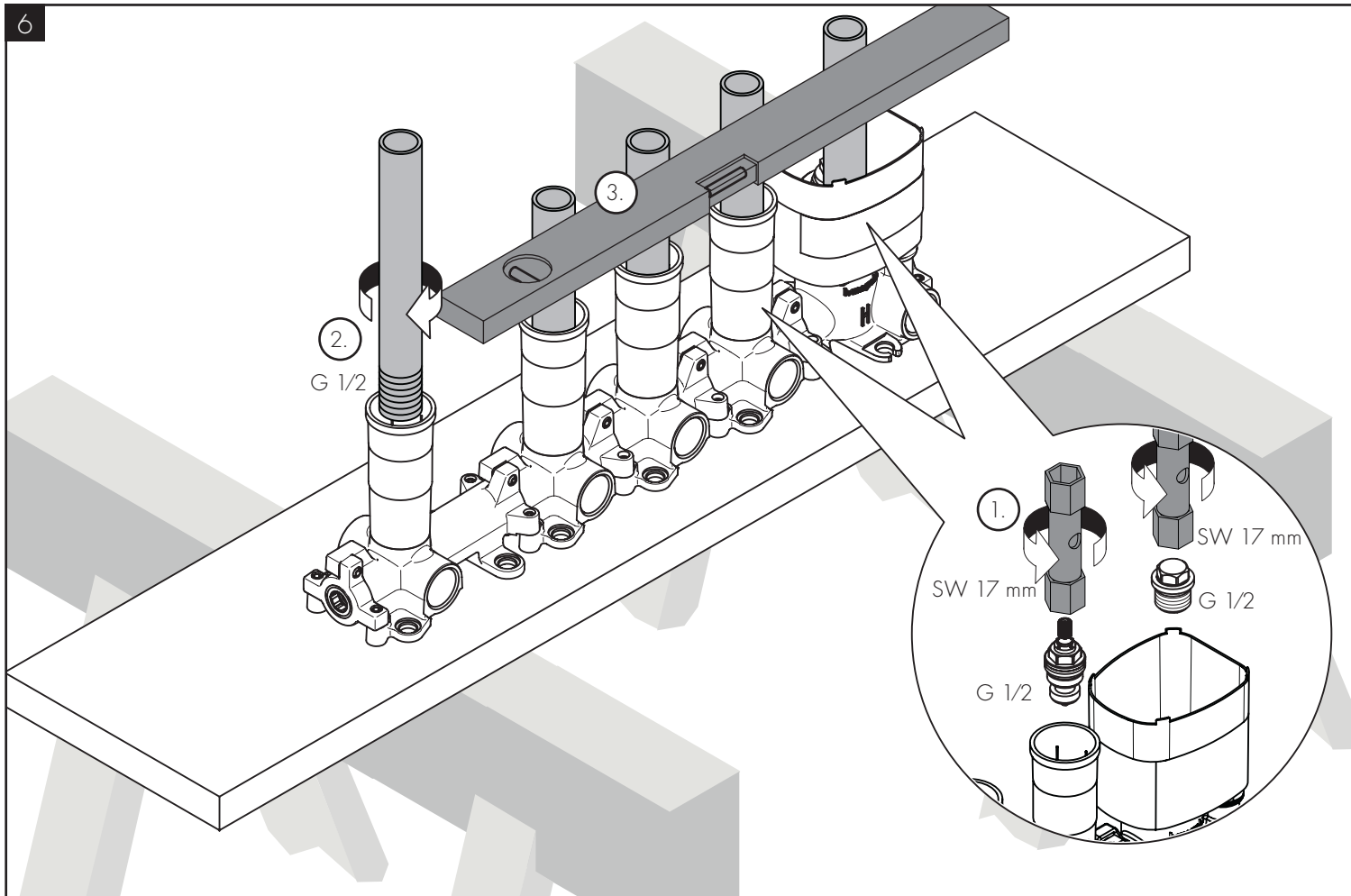

max./maks./最大/مáx./не
 более./ne daugiau kaip/tlak/azami/
 έως

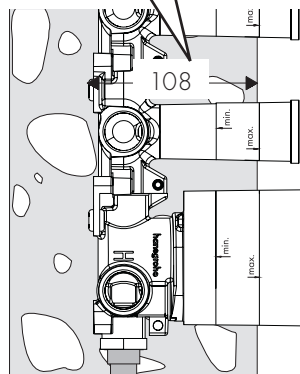

min./分钟/مáx./мин/περσ/dak

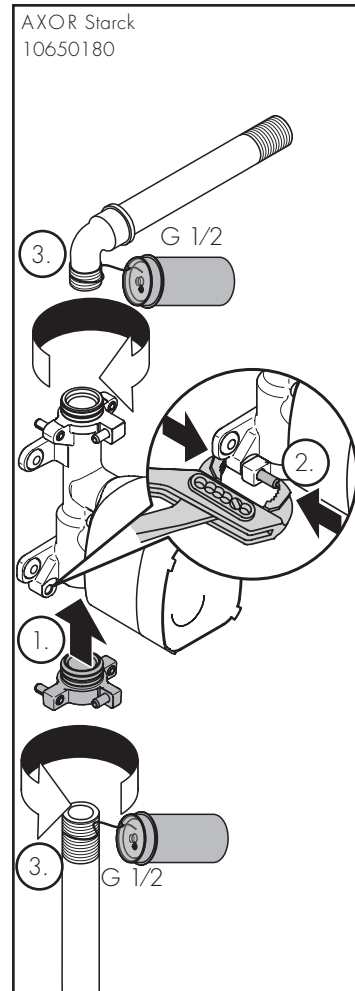
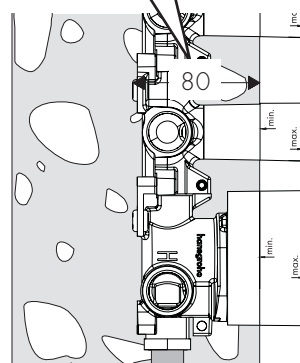



- DE / Spülen der Leitungen
 FR / Rincer les conduites
 EN / Flushing of the pipes.
 IT / Far scorrere l'acqua nel tubo
 ES / limpiar lavando los conductos
 NL / Doorspoelen van de leidingen
 DK / Skylling af ledninger
 PT / Lavagem das tubagens
 PL / Płukanie przewodów
 RU / Промывка трубопроводов
 CS / vypláchnout vedení
 SK / Vypláchnutie vedení.
 ZH / 冲洗管道。
 HU / A vezetékek öblítése
 FI / Johdotusten huuhtelu
 SV / Spola ledningarna
 LT / Išplauti vamzdžius
 HR / Ispiranje slavina
 TR / Hatların yıkanması
 RO / Spălarea conductelor
 EL / Καθαρισμός των αγωγών
 SL / Izpiranje cevi
 ET / Torude loputamine
 LV / Ūdens vada skalošana
 SR / Ispiranje cevi
 NO / Spyling av ledninger
 BG / Промиване на тръбопроводите
 SQ / Shpëlarja e lidhjeve
 AR / ريساومنا لبيسة

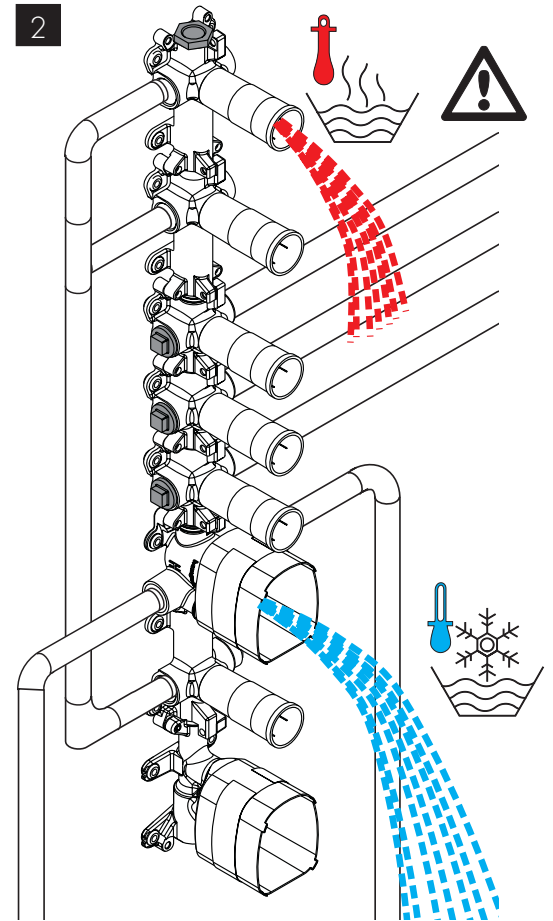
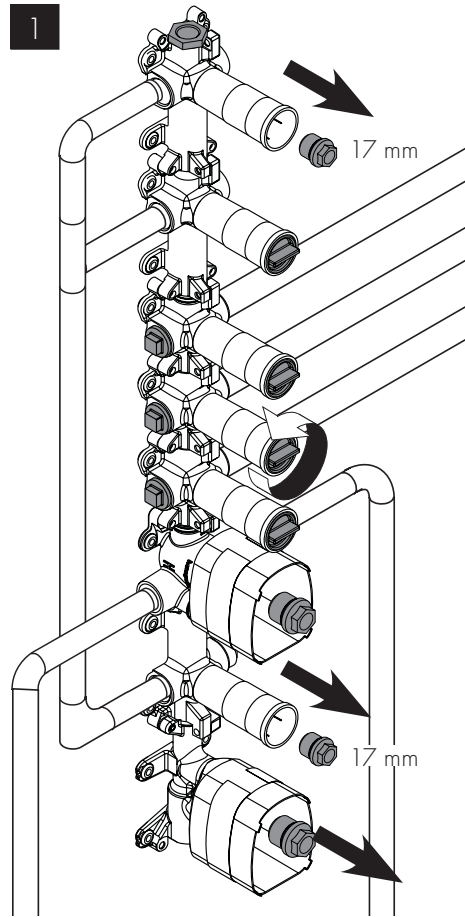

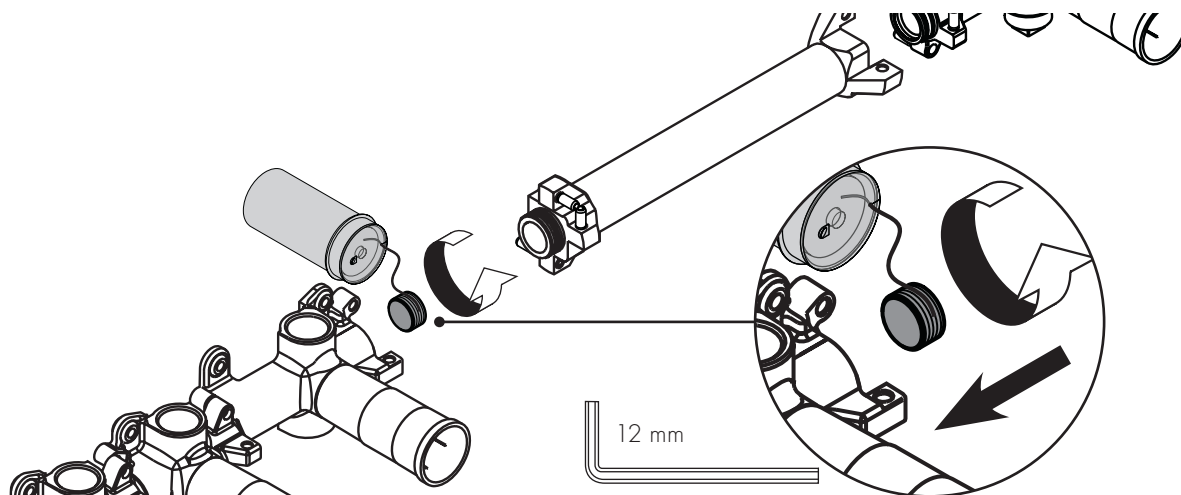

DE / Stopfen einschrauben

Folgt nach dem Grundkörper 40878/ 40877 kein Absperrventil, dann beigelegten Stopfen eindichten und einschrauben. So wird stagnierendem Wasser vorgebeugt.

FR / Visser l'obturateur

Si une vanne d'arrêt ne se trouve pas en aval du corps de base 40878/ 40877, étancher et visser l'obturateur fourni, évitant la stagnation d'eau.

EN / Screw in the plug

If there is no shutoff valve behind the basic body 40878/ 40877, seal the included plug and screw it in. This will prevent stagnating water.

IT / Avvitare i tappi

Se dopo il corpo base 40878/ 40877 non segue nessuna valvola d'arresto, allora ermetizzare il tappo e avvitarlo. Con ciò si previene a dell'acqua stagnata.

ES / Enrosca tapones

Si después del cuerpo básico 40878/ 40877 no sigue ninguna válvula de cierre, entonces se debe hermetizar y enrosca los tapones incluidos. De este modo se evita la acumulación de agua.

NL / Stop erin schroeven.

Indien na het basislichaam 40878/ 40877 geen afsluitlek volgt, moet de bijgevoegde stop afgedicht en ingeschroefd worden. Zo wordt stilstaand water voorkomen.

DK / Prop skrues i

Er der ikke nogen afspærringsventil efter grundelementet 40878/ 40877, tætnes vedlagte prop ind og skrues i. Således forebygges stagnerende vand.

PT / Enrosca o bujão

Se depois do corpo base 40878/ 40877 não se seguir nenhuma válvula de vedação, não se deve enrosca nem vedar o bujão fornecido. Desta forma previne a formação de água estagnada

PL / Wkręcanie korka

Jeżeli za korpusem 40878/ 40877 nie ma żadnego zaworu odcinającego, wówczas należy uszczelnić i wkręcić dołączony korek. W ten sposób zapobiega się gromadzeniu wody.

C S / Našroubování uzávěrů

Jestliže za základním tělesem 40878/40877 nenásleduje uzavírací ventil, potom utěsněte a našroubujte přiložené uzávěry. Předěje se tím stagnující vodě.

S K / Naskrutkovanie uzáverov

Ak za základným telesom 40878/40877 nie je uzatvárací ventil, potom utesnite a naskrutkujte priložené uzávěry. Predíde sa tým stagnujúcej vode.

Z H / 拧固堵头

基体 40878/ 40877 之后无截止阀，因此用堵头进行密封并用螺钉拧固。以防水平滞。

R U / Винтите заглушки

Если за основной частью 40878/ 40877 нет запорного клапана, тогда загерметизируйте и винтите приложенные заглушки. Таким образом, удастся предотвратить застаивание воды.

H U / Dugó becsavarása

Ha a 40878/40877 készüléktest után nincs zárószelep, akkor a mellékelt dugók kell behelyezni és becsavarni. Így meg lehet előzni a víz pangását.

F I / Tulpat ruuvataan kiinni

Jos perusosan 40878/ 40877 jälkeen ei tule sulkuventtiiliä, mukana olevat tulpat tiivistetään ja ruuvataan kiinni. Näin estetään veden kerääntyminen.

SV / Skruva i propp

Om det inte finns en spärrventil efter basenheten 40878/ 40877 ska den medföljande proppen sättas i och skruvas fast. Detta förebygger vattenstagnation.

LT / Kamščio užsukimas

Jeigu už pagrindinės dalies 40878/40877 nėra skiriamoji vožtuvu, užsandarininkite ir užsukite pridėdamus kamščius. Taip išvengiama vandens užsistovėjimo.

H R / Zavrtanje čepa

Ako iza tijela 40878/40877 ne slijedi zaporni ventil, onda priloženi čep treba zabrtviti i zavrtnuti. Na taj se način izbjegava stagniranje vode.

T R / Tapayı takın

Temel gövde 40878/ 40877'den sonra kapatma vanası yoksa, birlikte verilen tapayı izole edin ve vidalayın. Böylece suyun durgunlaşması önlenir.

RO / Înşurubarea dopului

În cazul în care după corpul de bază 40878/ 40877 nu este montată o supapă de închidere, etanşaţi dopul anexat şi înşurubaţi-l. În acest fel veţi evita formarea apei stagnante.

E L / Βιδώστε το βύσμα

Εφόσον δεν εγκατασταθεί μετά το βασικό στοιχείο 40878/ 40877 μία βαλβίδα διακοπής, θα πρέπει το βύσμα να βιδωθεί και να στεγανοποιηθεί ώστε να μην συγκεντρώνεται νερό.

S L / Uvijte zamašek

Če za osnovnim elementom 40878/ 40877 ni nameščena zaporna ventila, zatesnite in uvijte priložen zamašek. Tako preprečite nabiranje stagnirajoče vode.

E T / Keerake kork sisse

Kui põhikerele 40878/ 40877 ei järgne sulgurventili, siis tihendage kork ja keerake sisse. Sellega väldite seisvat vett.

LV / Aizbāžņu ieskrūvēšana

Ja pēc pamatnes 40878/ 40877 neseko slēgvārsts, noblīvējiet un ieskrūvējiet pievienotos aizbāžņus. Tādējādi tiek novērsta ūdens sastāšanās.

S R / Skru inn plugg

Hvis ikke det følger en sperreventil etter basiskabinettet 40878/40877 skal man skru inn og tette med medlevert plugg. Slik forebygges stagnerende vann.

N O / Skru inn plugg

Hvis ikke det følger en sperreventil etter basiskabinettet 40878/40877 skal man skru inn og tette med medlevert plugg. Slik forebygges stagnerende vann.

B G / Завинтите пробката

Ако след основното тяло 40878/ 40877 няма спиращен клапан, тогава уплътнете и завинтите приложената пробка. Така се предотвратява застоя на вода.

S Q / Vidhosni tapën

Nëse pas njësisë kryesore 40878/ 40877 nuk vjen asnjë valvul bllokuese, atëherë izoloni dhe vidhosni tapat e dërguara. Në këtë mënyrë do të parandalohet uji i ndenjtur.

A R /

تركيب السدادات

إذا لم يتبع الجسم الرئيسي / صمام مانع للتدفق، قم بتركيب السدادات المرفقة وثبتها بإحكام، مما سيمنع تكون أي مياه راكدة.

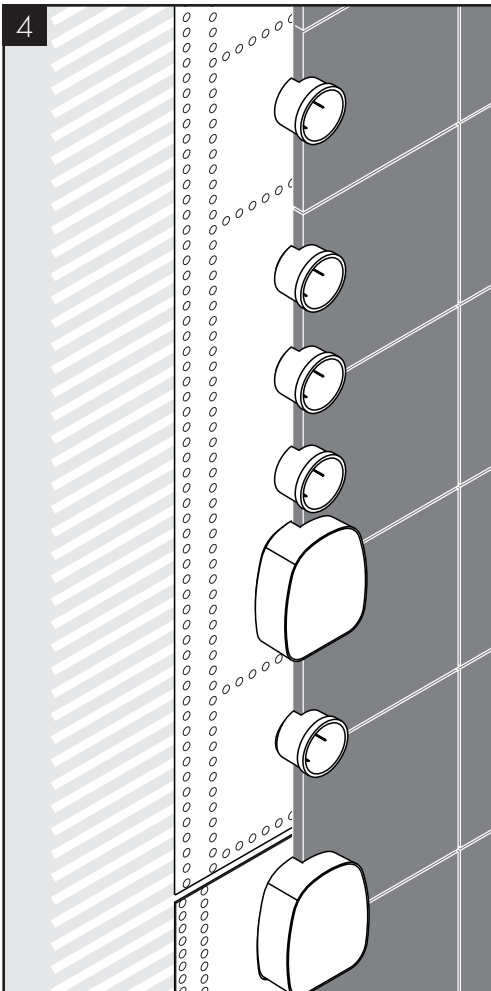
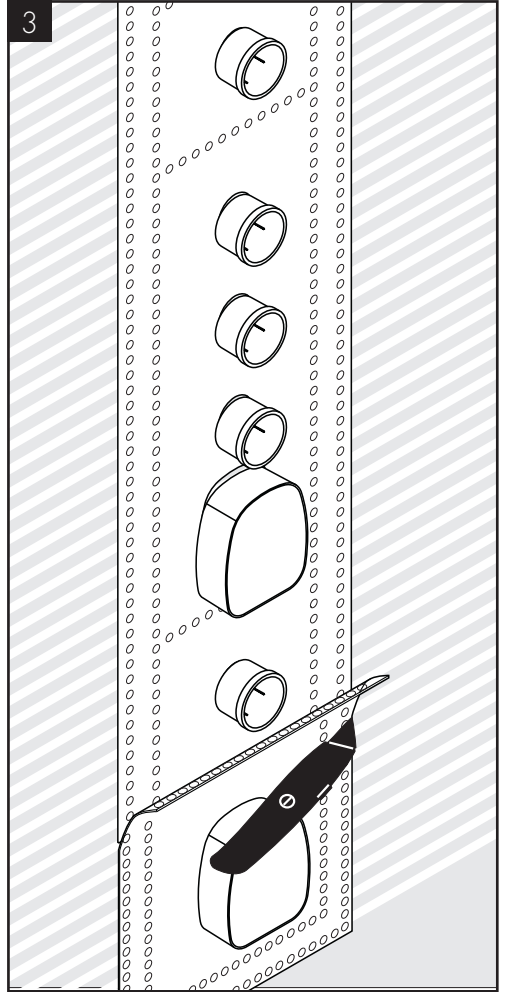
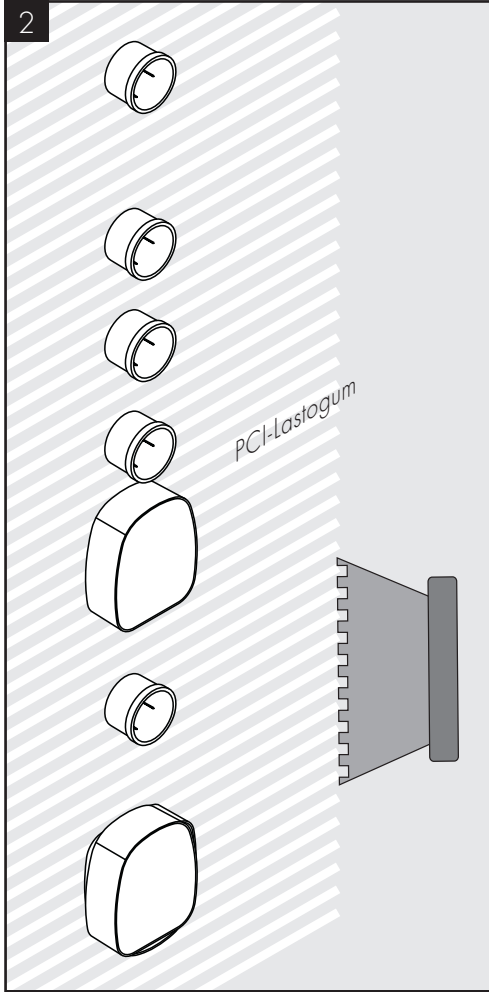
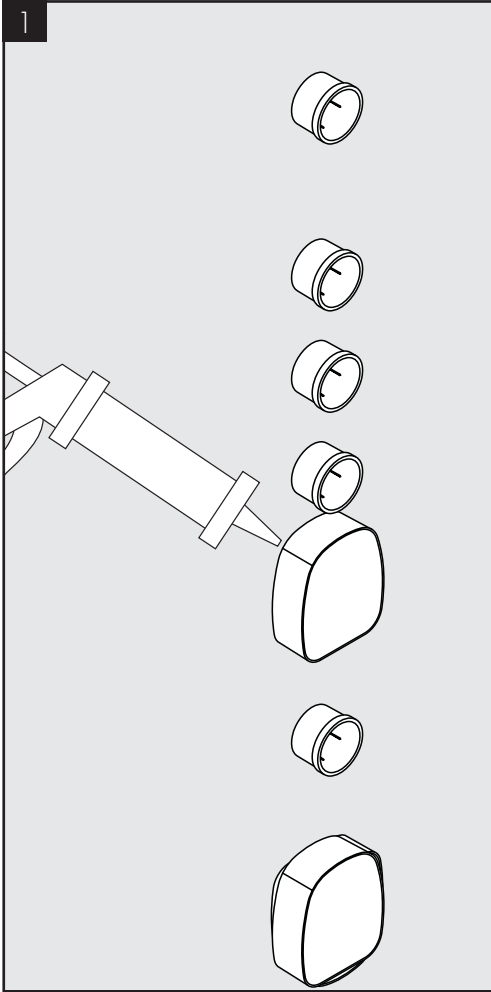



AXOR ShowerCollection

10750180

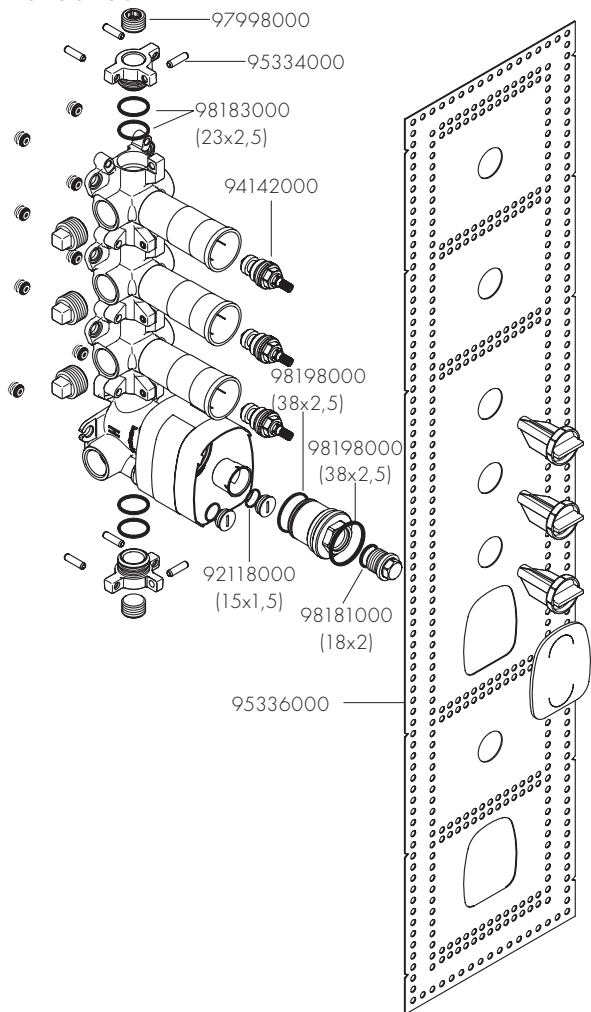

AXOR ShowerCollection

10650180

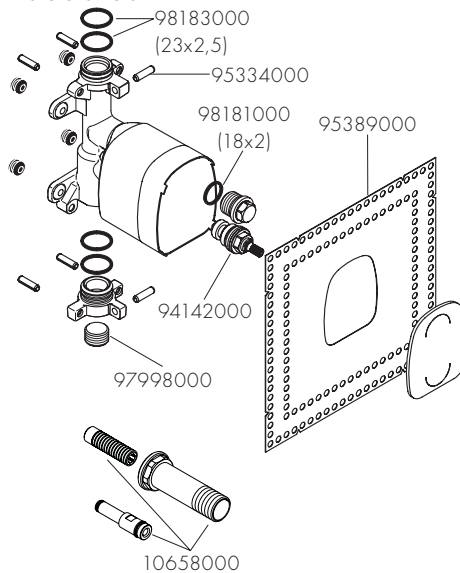

AXOR ShowerCollection

10971180

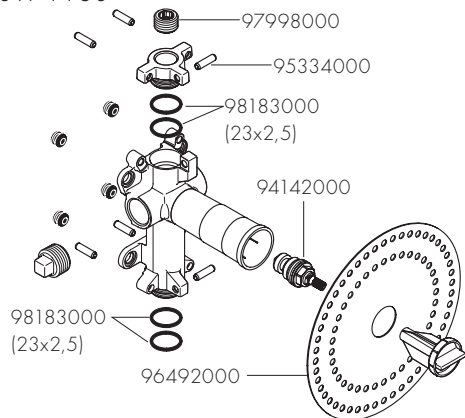

AXOR ShowerCollection

28486180

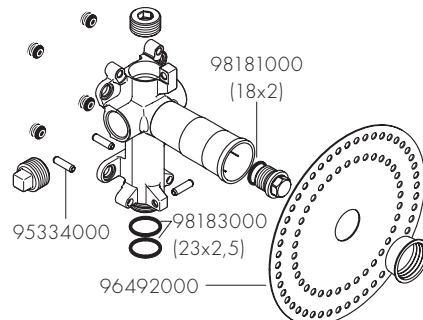

	P-IX	DVGW	SINTEF	NF	STF	CERTIFICATION BOARD SE 4 KIWA
10650180	P-IX 29508/IO		X			X
10750180			X			X
10971180						X
28486180	P-IX 19159/IZ					

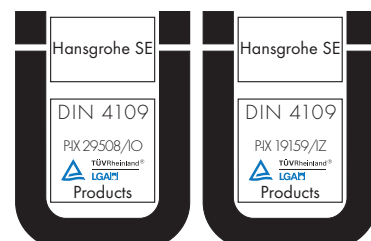

AXOR

AXOR / Hansgrohe SE
Austraße 5-9
77761 Schiltach
Deutschland

info@axor-design.com
axor-design.com

07/2019
9.04829.03