

# hansgrohe

- DE** Montageanleitung
- FR** Instructions de montage
- EN** Assembly instructions
- IT** Istruzioni per Installazione
- ES** Instrucciones de montaje
- NL** Handleiding
- DK** Monteringsvejledning
- PT** Manual de Instalação
- PL** Instrukcja montażu
- CS** Montážní návod
- SK** Montážny návod
- ZH** 组装说明
- RU** Инструкция по монтажу
- HU** Szerelési útmutató
- FI** Asennusohje
- SV** Monteringsanvisning
- LT** Montavimo instrukcijos
- HR** Uputstva za instalaciju
- TR** Montaj kılavuzu
- RO** Instrucțiuni de montare
- EL** Οδηγία συναρμολόγησης
- SL** Navodila za montažo
- ET** Paigaldusjuhend
- LV** Montāžas instrukcija
- SR** Uputstvo za montažu
- NO** Montasjeveiledning
- BG** Инструкция за употреба
- SQ** Udhëzime rreth montimit
- AR** تعليمات التجميع
- JP** 施工説明書

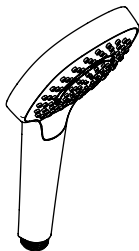
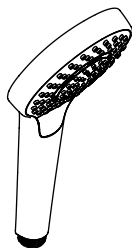

### Cromo Select S Multi

26800XXX  
26801XXX (9 l/min)

### Cromo Select S Vario

26802XXX  
26803XXX (9 l/min)

### Cromo Select S 1jet

26804XXX  
26805XXX (9 l/min)  
26806XXX (7 l/min)

### Cromo Select E Multi

26810XXX  
26811XXX (9 l/min)

### Cromo Select E Vario

26812XXX  
26813XXX (9 l/min)

### Cromo Select E 1jet

26814XXX  
26815XXX (9 l/min)  
26816XXX (7 l/min)

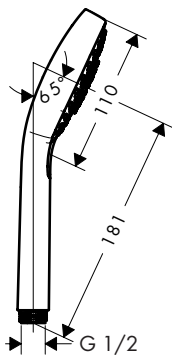
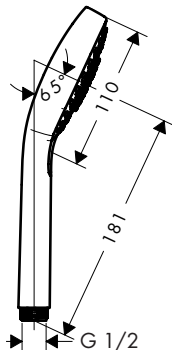

- DE** Reinigungsempfehlung / Garantie / Kontakt  
**FR** Recommandation pour le nettoyage / Garanties / Contact  
**EN** Cleaning recommendation / Warranty / Contact  
**IT** Raccomandazione di pulizia / Garanzia / Contatto  
**ES** Recomendaciones para la limpieza / Garantía / Contacto  
**NL** Aanbevelingen inzake reiniging / Garantie / Contact  
**DK** Rengøringsvejledning / Garanti / Kontakt  
**PT** Recomendações de limpeza / Garantia / Contacto  
**PL** Zalecenie dotyczące pielęgnacji / Gwarancja / Kontakt  
**CS** Doporučení k čištění / Záruka / Kontakt  
**SK** Odporúčania pre čistenie / Záruka / Kontakt  
**ZH** 清洁指南 / 担保 / 接触  
**RU** Рекомендации по очистке / Гарантия / Контакты  
**FI** Puhdistussuositus / Takuu / Kosketus  
**SV** Rengöringsrekommendationer / Garanti / Contacto  
**LT** Valymo rekomendacijos / Garantija / Kontaktai  
**HR** Preporuke za čišćenje / Garancija / Kontakt  
**TR** Temizleme önerisi / Garanti / Temas  
 Garanti belgesi ve koşulları için [www.hansgrohe.com.tr](http://www.hansgrohe.com.tr) web sitesini ziyaret ederek; dijital garanti belgenize ulaşabilirsiniz.  
**RO** Recomandări pentru curățare / Garanție / Contact  
**EL** Σύσταση καθαρισμού / Εγγύηση / επαφή  
**SL** Priporočilo za čišćenje / Garancija / Kontakt  
**ET** Puhastussuositused / Garantii / Kontakt  
**LV** Tīrīšanas ieteikumi / Garantija / Kontakti  
**SR** Preporuke za čišćenje / Garancija / Kontakt  
**NO** Anbefaling for rengjøring / Garanti / Kontakt  
**BG** Препоръка за почистване / Гаранция / Контакт  
**SQ** Këshilla rreth pastrimit / Garancia / Kontakt  
**KO** 세정시 권장사항 / 품질보증 / 접촉  
**AR** توصيات التنظيف / الضمان / اتصال  
**HU** Tisztítási tanácsok / Garancia / érintkezés  
**JP** お手入れの方法 / 保証について / ご連絡先



[www.hansgrohe.com/cleaning-recommendation](http://www.hansgrohe.com/cleaning-recommendation)

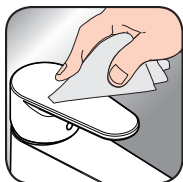

[www.hansgrohe.com/cleaning-recommendation](http://www.hansgrohe.com/cleaning-recommendation)



[www.hansgrohe.com/cleaning-recommendation](http://www.hansgrohe.com/cleaning-recommendation)



[www.hansgrohe.com/cleaning-recommendation](http://www.hansgrohe.com/cleaning-recommendation)

**DE** Einfach sauber: Kalk lässt sich von den Noppen ganz leicht abrubbeln.

**FR** La propreté en toute simplicité: les dépôts formés sur les buses élastiques en silicone s'éliminent par un simple passage de la main.

**EN** Just clean: simply rub over the spray nozzles to remove lime scale.

**IT** Facile da pulire: Il calcare viene eliminato semplicemente dagli ugelli elastici in silicone.

**ES** Fácil aseo: La cal se puede retirar sencillamente frotando con los dedos de las toberas elásticas de silicona.

**NL** Eenvoudig schoon: Kalk kan eenvoudig van de noppen worden gewreven.

**DK** Enkel rengøring: Det er let at fjerne kalkaflejinger fra stråledyserne.

**PT** Simplesmente limpo: o calcário pode ser simplesmente retirado das saliências através de fricção.

**PL** Po prostu czysto: Pęczki można całkiem łatwo oczyścić z kamienia.

**CS** Jednoduše čistě: Vapenné usazeniny můžete z noplek snadno odstranit otřením.

**SK** Jednoducho čistý: Vodný kameň sa dá zo štetín celkom ľahko odstrániť.

**ZH** 清洁: 只需要揉搓花洒表面的出水孔即可去除水垢。

**RU** Простота чистки: известь очень легко стирается с утолщений.

**FI** Yksinkertaisesti puhdas: kalkin voi helposti hieroa irti nypystä.

**SV** Enkelt att göra rent: det är lätt att ta bort kalk från nopporna.

**LT** Paprasta švara: kalkės lengvai nugarandomos nuo kilpos.

**HR** Jednostavno čisto: Kamenac se sasvim lako uklanja s izbočina.

**RO** Pur și simplu curat: Calcarul se îndepărtează ușor de pe noduri prin frecare.

**TR** Sadece temiz: Kireç, düğümlemler kolayca ovalanabilir.

**EL** Απλά τέλεια καθαριότητα: Τα άλατα μπορούν να αφαιρεθούν με μεγάλη ευκολία από τα στόμια.

**SL** Preprosto čisto: arpenec se z lahkoto podrgne z vozličkov.

**ET** Lihtsalt puhas: lujja saab nuppu deli lihtsalt maha hõõruda.

**LV** Vienkārša tīrīšana: kalkis no izvirzījumiem ir viegli norubināms.

**SR** Jednostavno čisto: Kamenac se sasvim lako skida sa izbočina.

**NO** Simpelt ren: Ved å gnikke er det lett å fjerne kalk fra nuppene.

**BG** Просто чисто: Варовикът лесно може да се изтресе от удебеленията.

**SQ** Thjesht dhe pastër. Mbetjet gëlqerore mund të hiqen me fërkim të lehtë.

**AR** إنه سهل التنظيف، حيث يسقط الجير بسهولة شديدة من الأجزاء الناتئة

**HU** Egyszerűen tiszta: a vízkő egészen könnyen ledörzsölhető a csomókról.

**JP** 清掃が簡単: カルキは突起部から簡単にこすり落とすことができます。

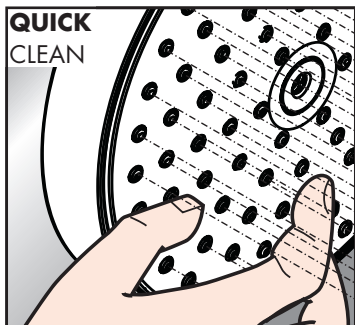

## Service

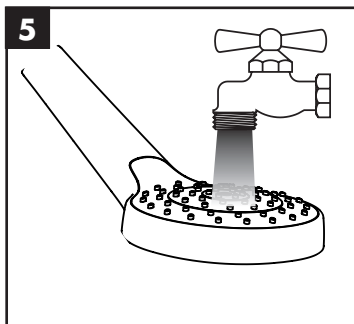
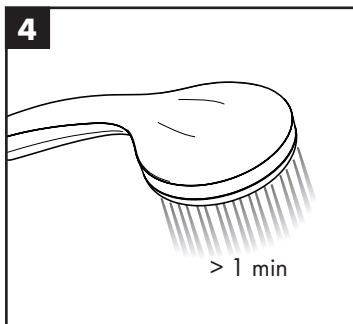
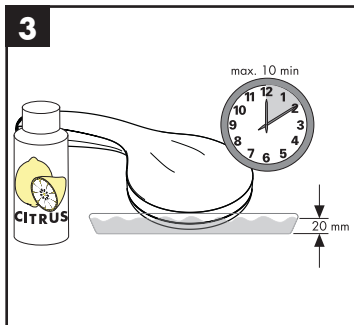
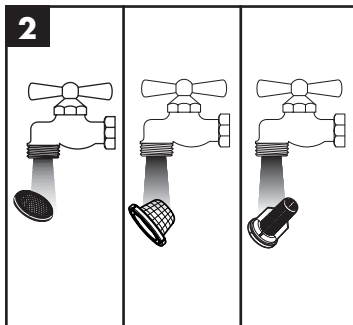
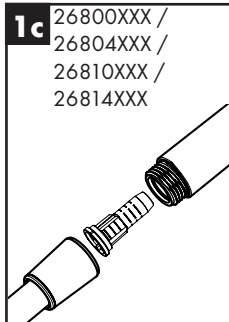
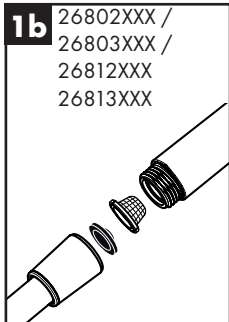
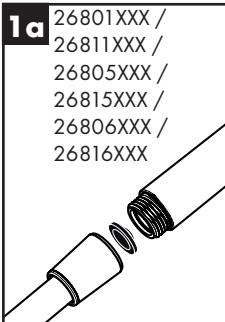

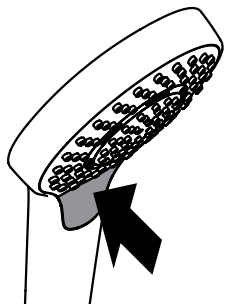

**Croma Select S Vario**  
26803XXX

**Croma Select E Vario**  
26813XXX

**Croma Select S Multi**  
26800XXX

**Croma Select S Vario**  
26802XXX

**Croma Select E Multi**  
26810XXX

**Croma Select E Vario**  
26812XXX

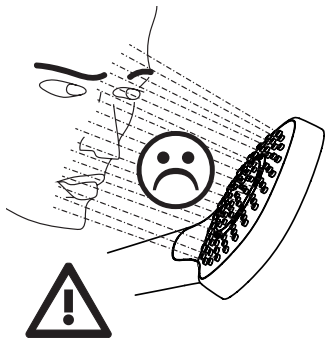

94246000



92672000

98058000  
(not included)



5



97708000

98058000  
(not included)





**P** max.  
0,6 MPa  
6 bar

0,12 - 0,4 MPa  
1,2 - 4 bar

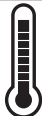

**T** max.  
60 °C

< 50 °C

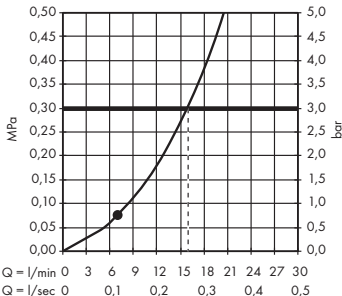

**Cromas Select S 1jet 26804XXX**

**Cromas Select E 1jet 26814XXX**

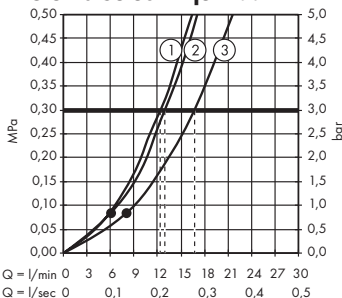

**Cromas Select S Multi 26800XXX**

**Cromas Select E Multi 26810XXX**



TurboRain



IntenseRain



Rain



Massage



IntenseRain



SoftRain



**P** max.  
0,6 MPa  
6 bar

0,12 - 0,4 MPa  
1,2 - 4 bar

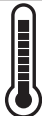

**T** max.  
60 °C

< 50 °C

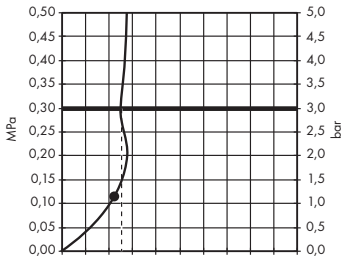

Q = l/min 0 3 6 9 12 15 18 21 24 27 30  
Q = l/sec 0 0,1 0,2 0,3 0,4 0,5

**Croma Select S 1jet 26805XXX**

**Croma Select E 1jet 26815XXX**

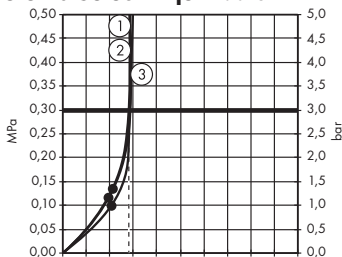

Q = l/min 0 3 6 9 12 15 18 21 24 27 30  
Q = l/sec 0 0,1 0,2 0,3 0,4 0,5

**Croma Select S Vario 26803XXX**

**Croma Select E Vario 26813XXX**



TurboRain



IntenseRain



Rain



IntenseRain



Massage



SoftRain

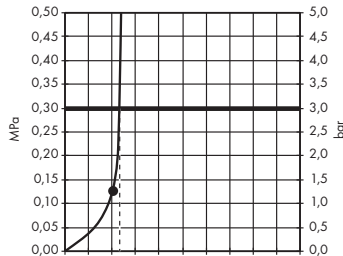

Q = l/min 0 3 6 9 12 15 18 21 24 27 30  
Q = l/sec 0 0,1 0,2 0,3 0,4 0,5

**Croma Select S 1jet 26806XXX**

**Croma Select E 1jet 26816XXX**

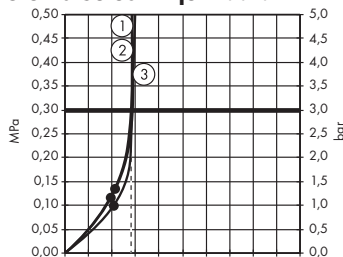

Q = l/min 0 3 6 9 12 15 18 21 24 27 30  
Q = l/sec 0 0,1 0,2 0,3 0,4 0,5

**Croma Select S Multi 26801XXX**

**Croma Select E Multi 26811XXX**

	<b>P-IX</b>	<b>DVGW</b>	<b>NF</b>
<b>26800XXX</b>	P-IX 28499/IB		X
<b>26802XXX</b>	P-IX 28500/IB		X
<b>26804XXX</b>	P-IX 28501/IB		
<b>26810XXX</b>	P-IX 28502/IB		X
<b>26812XXX</b>	P-IX 28503/IB		X
<b>26814XXX</b>	P-IX 28504/IB		X
<b>26801XXX</b>	P-IX 29820/IZ		
<b>26803XXX</b>	P-IX 29821/IZ		X
<b>26805XXX</b>	P-IX 29822/IZ		
<b>26806XXX</b>	P-IX 29822/IZ		
<b>26811XXX</b>	P-IX 29824/IZ		
<b>26813XXX</b>	P-IX 29825/IZ		X
<b>26815XXX</b>	P-IX 29831/IZ		
<b>26816XXX</b>	P-IX 29826/IZ		

Hansgrohe SE

**DIN 4109-1**

P-IX 28499/IB

P-IX 28500/IB

P-IX 28501/IB



Hansgrohe SE

**DIN 4109-1**

P-IX 28502/IB

P-IX 28503/IB

P-IX 28504/IB



Hansgrohe SE

**DIN 4109-1**

P-IX 29820/IZ

P-IX 29821/IZ

P-IX 29822/IZ



Hansgrohe SE

**DIN 4109-1**

P-IX 29823/IO

P-IX 29824/IZ

P-IX 29825/IZ



Hansgrohe SE

**DIN 4109-1**

P-IX 29831/IZ

P-IX 29826/IO



**hansgrohe**

Hansgrohe · Austraße 5 - 9 · D-77761 Schiltach  
 Telefon +49 (0) 78 36/51-1282 · Telefax +49 (0) 7836/511440  
 E-Mail: info@hansgrohe.com · Internet: www.hansgrohe.com

03/2022  
 9.02429.06 R01