



# Pura

## 50×36 swirlflush



Wc  
50×36 cm  
25 kg

WC predisposto per scarico a parete oppure a pavimento tramite curva tecnica, con sistema di scarico **Swirlflush**®



Back to wall Wc with wall or floor (through a pipe fitting) outlet with **Swirlflush**® system.



swirlflush®



extraglaze antibacterial®



quickrelease





softclose

Colori - Colours	Codici - Codes	Fori - Tapholes
<input type="radio"/> Bianco lucido - White glossy	8820 11	-

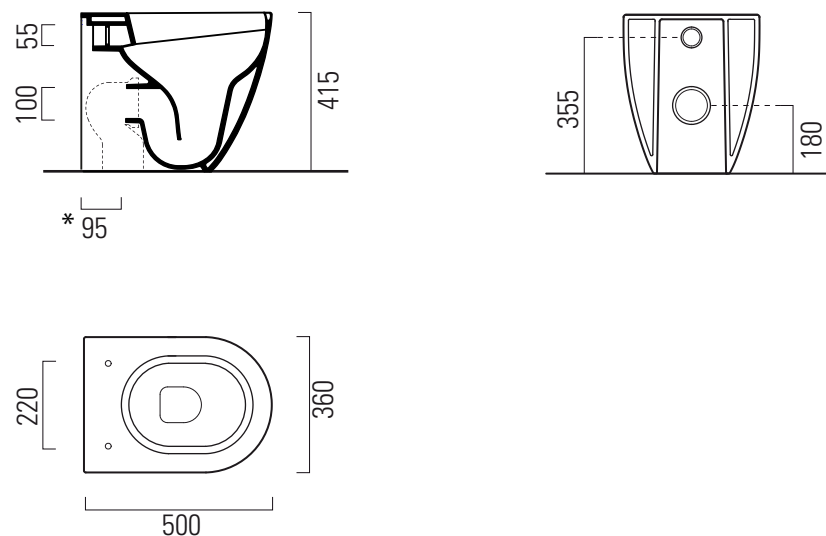
Non è consigliato l'impiego di cassette di scarico esterne, impianti dotati di rubinetto flussometro e cassette h 82/83cm.  
 We do not recommend the use of external flushing cisterns, systems endowed with flushometer valves and flushing cisterns h82/83cm.



Raccordi di scarico - Flushing connections	Codici - Codes	Interasse - Distance
	MCURVA	* 95 mm
	MCURVA90	* 65 mm

**Testato con i seguenti dispositivi di scarico | Tested with the following flushing mechanisms**  
 GEBERIT art. 109.770.00.1 h1060mm - OLI 74 plus h1050mm - VALSIR Winner S h1140mm - VALSIR Tropea S h1060mm - VALSIR Cubik S h1060mm  
 VIEGA art. 771 904 h1000mm - VIEGA art. 771 904 h920mm - TECE BOX art. 9041012 h1060mm - GEBERIT art. 109.790.00.1 h1045mm - GROHE art.38863 h1045